

CATALOGUE

SURGICAL INSTRUMENTS

Serving Your Health With Excellence





Buck
AI-1-102-18
Percussion Hammer
20cm,



Buck
AI-1-101-18
Percussion Hammer
18.5 cm,

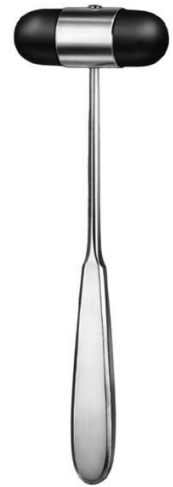

Dejerine
AI-1-103-20
Percussion Hammer
20cm,



Dejerine
AI-1-104-21
Percussion Hammer
21cm,



Taylor Mod. USA
AI-1-105-20
Percussion Hammer
20cm,



Wartenberg
AI-1-106-19
Pinwheel
18cm,



Pinard
AI-1-107-18
Stethoscope
18 cm,



Pinard
AI-1-108-15
Stethoscope
15cm,



Magill
AI-2-101-15
Catheter Introducing Forceps
14.5 cm, 20 cm, 25 cm,



Miller
AI-2-102-00
Laryngoscope Sets



Miller-Baby
AI-2-103-00
Laryngoscope Sets



Miller
AI-2-104-00
Laryngoscope Blade
Fig. 0, Fig. 1, Fig. 2, Fig. 3, Fig. 4,



Guedel-Negus
AI-2-105-00
Laryngoscope Sets
Fig. 2, Fig. 3, Fig. 4,



Guedel-Negus
AI-2-106-00
Laryngoscope Sets
Fig. 1, Fig. 2, Fig. 3, Fig. 4,



Guedel-Negus
AI-2-107-01

Laryngoscope Blades
Fig. 1, Fig. 2, Fig. 3, Fig. 4,



McIntosh
AI-2-108-00



McIntosh
AI-2-109-00

Laryngoscope Blades
Fig. 0, Fig. 1, Fig. 2, Fig. 3, Fig. 4,



McIntosh
AI-2-110-00

Laryngoscope Sets
Fig. 1, Fig. 2, Fig. 3, Fig. 4,



Foregger
AI-2-111-01

Laryngoscope Blades
Fig. 1, Fig. 2, Fig. 3, Fig. 4,



Battery Handle
AI-2-112-00
Battery Handle



McIntosh
AI-2-114-00

Laryngoscope Sets fiber optic
Fig. 1, Fig. 2, Fig. 3,



McIntosh
AI-2-115-00

Laryngoscope Sets fiber optic
Fig. 1, Fig. 2, Fig. 3,



McIntosh
AI-2-116-00

Laryngoscope Sets fiber optic
Fig. 1, Fig. 2, Fig. 3,



McIntosh
AI-2-113-00

Laryngoscope Sets
Fig. 1, Fig. 2, Fig. 3, Fig. 4,



Universal
AI-3-101-04
Trocar
14 cm,



Nelson
AI-3-102-07
Trocar
20 cm,



Lichtwitz
AI-3-103-19
Antrum Trocar
18.5 cm,



Adson
AI-3-104-21
Suction Cannula
20 cm,



Frazier
AI-3-105-10
Suction Cannula
24 cm,



Frazier
AI-3-106-06
Suction Cannula
19.5 cm,



Poppen
AI-3-107-06
Suction Cannula
18 cm,



Luer
AI-3-108-30
Suction Tube working length 110 mm



Yasargil
AI-3-109-15
Suction Tube working length 150 mm with
Luer hub
21.5 cm,



Yankauer
AI-3-110-27
Suction Tube complete with suction tip and
connector
31 cm,



Yankauer
AI-3-111-00
Suction Tube
31 cm, 15 cm, 2.5 cm, 10 cm,



Poole
AI-3-112-22
Suction Tube
22 cm,



Poole
AI-3-113-22
Suction Tube
22.5 cm,



Nuboer
AI-3-114-21
Suction Tube
21 cm,



Nuboer
AI-3-115-21
Suction Tube
21 cm,



Quinke
AI-3-116-10
Lumbar Puncture Needle



Tuohy
AI-3-117-12
Lumbar Puncture Needle Luer Lock
connection with special tip



Verres
AI-3-118-20
Insufflation Cannula Luer Lock connection
15 cm,



Verres

AI-3-119-20

Insufflation Cannula Luer Lock connection
17 cm,



Kalt
AI-4-105-14
Needle Holder
13.5 cm,



Barraquer-Troutman
AI-4-106-10
Micro Needle Holder
10 cm, 10.5 cm,



Arruga
AI-4-107-14
Micro Needle Holder
13.5 cm,



Barraquer-Troutman
AI-4-108-10
Micro Needle Holder
10.5 cm, 11.5 cm,



Barraquer
AI-4-109-11
Micro Needle Holder
11.5 cm, 13.5 cm, 14 cm,



Barraquer
AI-4-110-13
Micro Needle Holder
13.5 cm,



Castroviejo-Fino
AI-4-111-01
Micro Needle Holder
13 cm,



Castroviejo-Fino
AI-4-112-01
Micro Needle Holder
13 cm,



Castroviejo-Fino
AI-4-113-01
very delicate jaw with lock
13 cm,



Castroviejo
AI-4-114-14
Micro Needle Holder with lock
14 cm,



Castroviejo
AI-4-115-14
Micro Needle Holder
14 cm,



Castroviejo
AI-4-121-14
Micro Needle Holder with lock
14 cm,



Castroviejo
AI-4-122-14
Micro Needle Holder
14 cm,



Castroviejo
AI-4-124-13
Micro Needle Holder with lock
12 cm,



Arruga
AI-4-123-16
Needle Holder delicate
16 cm,



Castroviejo
AI-4-125-12
Micro Needle Holder with lock
12 cm,



Derf
AI-4-126-12
Needle Holder
12 cm, 13 cm,

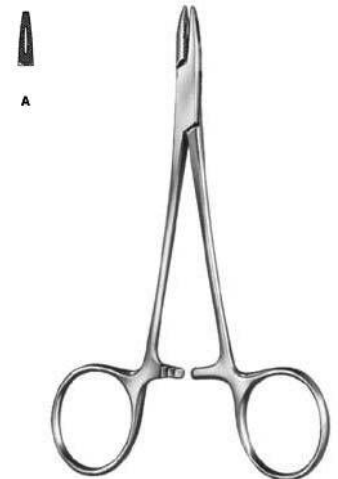

Collier
AI-4-127-12
Needle Holder
12.5 cm,



A



Webster
AI-4-128-13
 Needle Holder
 13 cm,



A



Halsey
AI-4-129-13
 Needle Holder
 13.5 cm,



C B A



Neivert
AI-4-130-13
 Needle Holder
 12.5 cm,



A



Hegar-Baumgartner
AI-4-131-14
 Needle Holder
 14.5 cm,



A



Crile-Murray
AI-4-133-15
 Needle Holder
 15 cm,



A



Crile-Wood
AI-4-134-15
 Needle Holder
 15 cm,



Adson

AI-4-140-18

Needle Holder one fenestrated jaw
18 cm,



Metzenbaum

AI-4-141-18

Needle Holder one grooved and fenestrated
jaw
18.5 cm,



M. G. Hospital

AI-4-142-17

Needle Holder
17.5 cm,



Mayo-Hegar

AI-4-143-14

Needle Holder

14.5 cm, 16 cm, 18.5 cm, 20.5 cm, 24 cm, 26.5
cm,



Mayo-Hegar

AI-4-144-16

Needle Holder

16 cm, 18.5 cm, 20.5 cm,



Brown

AI-4-145-13

Needle Holder

13 cm, 18 cm,

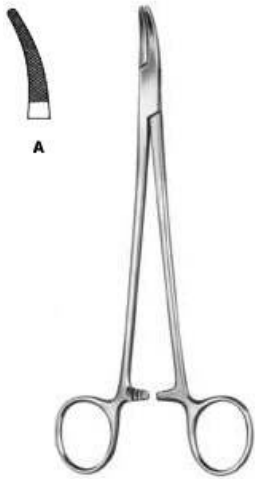

Heaney
AI-4-146-21
Needle Holder
20.5 cm,

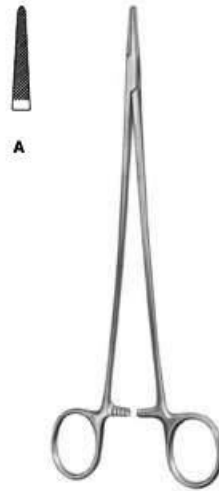

Jamison
AI-4-147-23
Needle Holder
23.5 cm,



Masson
AI-4-148-27
Needle Holder
26.5 cm,



Finochietto
AI-4-149-27
Needle Holder
26.5 cm,



Wangenstein
AI-4-150-27
Needle Holder
26.5 cm,

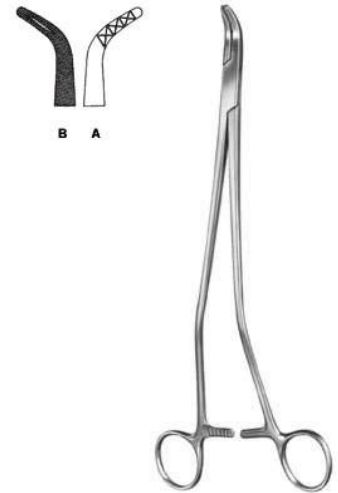

Johnson
AI-4-151-27
Needle Holder
27 cm,

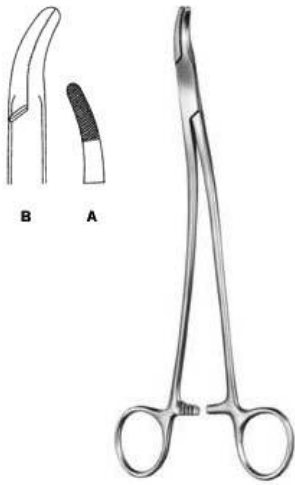

Stratte
AI-4-152-23
Needle Holder
23 cm,

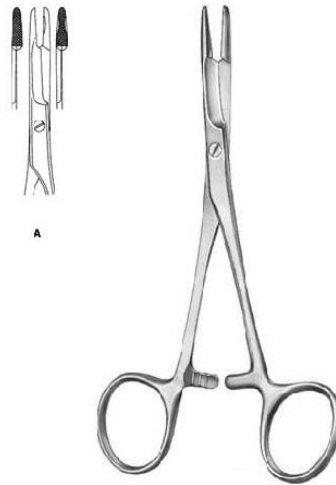

Olsen-Hegar
AI-4-153-14
Needle Holder
14 cm,

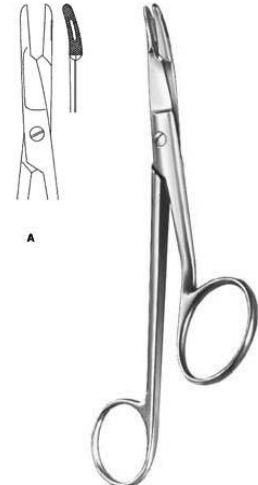

Gillies
AI-4-154-16
Needle Holder
16 cm,



Crile
AI-4-155-15
Needle Holder
15 cm,



Mathieu
AI-4-156-14
Needle Holder
14 cm, 17 cm, 20 cm,



Mathieu
AI-4-157-14
Needle Holder
14 cm, 16.5 cm,



Toennis
AI-4-158-18
Needle Holder
18.5 cm,



Lichtenberg
AI-4-159-20
Needle Holder
20 cm,



AI-4-160-16
Micro Needle Holder
16 cm,

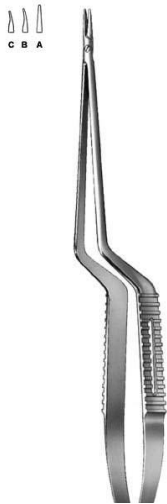

AI-4-161
Micro Needle Holder
23 cm, 19 cm,



Hepp-Scheidel
AI-4-162-18
Micro Needle Holder smooth jaw
18 cm,

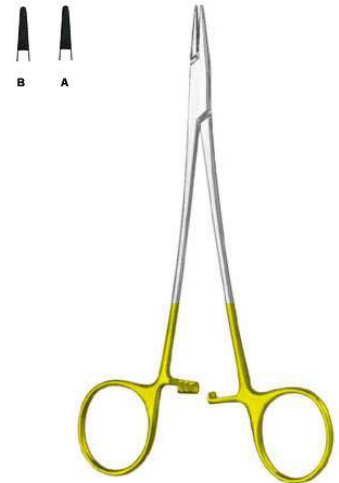

Webster
AI-4-163-13
Needle Holder with automatic release ratchet
also for lefthanders
13 cm, 15 cm,



AI-4-164-15

Micro Needle Holder
15 cm, 18 cm, 21 cm, 23 cm,



JABOMA

AI-4-165-18

Micro Needle Holder
18 cm,



Castroviejo

AI-4-166

Micro Needle Holder
14.5 cm, 18 cm, 21.5 cm,



Arruga

AI-4-167

Needle Holder
16 cm,



Castroviejo

AI-4-168-13

Micro Needle Holder
12.5 cm,



Barraquer

AI-4-169-13

Micro Needle Holder
13 cm,



Barraquer
AI-4-170-13
Micro Needle Holder
13 cm,



Webster
AI-4-171-13
Needle Holder
13 cm,



Derf
AI-4-173-12
Needle Holder
12 cm,

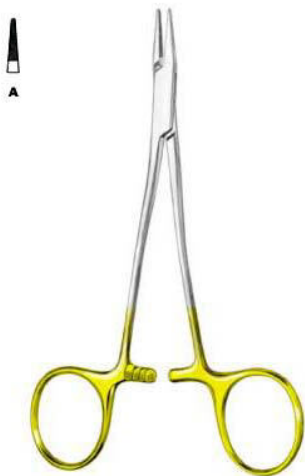

Kilner
AI-4-172-13
Needle Holder
13 cm,



Hegar-Baumgartner
AI-4-174-13
Needle Holder
13 cm, 14.5 cm,



Halsey
AI-4-175-12
Needle Holder
13 cm, 12 cm,



Crile-Wood
AI-4-176-15
Needle Holder
15 cm,



Sarot
AI-4-177-18
Needle Holder
18 cm, 20 cm, 26 cm,

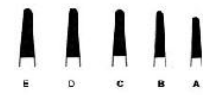

Mayo-Hegar
AI-4-178-16
Needle Holder standard profile
16 cm, 18 cm, 20 cm, 24 cm, 26 cm, 30 cm,



Heaney
AI-4-179-20
Needle Holder
20 cm, 24 cm, 26 cm,

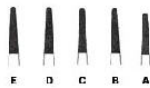

DeBakey
AI-4-180-18
Needle Holder delicate pattern mini profile
18 cm, 20 cm, 23 cm, 26 cm, 31 cm,



Masson
AI-4-181-27
Needle Holder
26.5 cm,

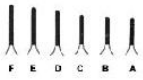

Ryder (Martin)
AI-4-182-13

Needle Holder
12.5 cm, 15 cm, 18 cm, 20 cm, 23 cm, 26 cm,



Martin
AI-4-183-15

Needle Holder mini profile elastic type
15 cm, 17 cm, 20 cm,



Wangensteen
AI-4-184-27

Needle Holder standard profile
27 cm,



Hegar-Vascular
AI-4-185-14

Needle Holder micro profile
14 cm, 18.5 cm, 20.5 cm, 23 cm,

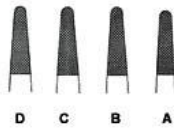

Bozemann
AI-4-186-20

Needle Holder standard profile
20.5 cm, 24 cm, 26.5 cm, 29 cm,



Hegar
AI-4-187-20

Needle Holder standard profile
20 cm, 23.5 cm,



Stratte

AI-4-188-22

Needle Holder standard profile
23 cm,



Microvascular

AI-4-189-00

Needle Holder slender pattern micro profile
14 cm, 17.5 cm, 20 cm, 23 cm,



Mathieu

AI-4-190-14

Needle Holder
14 cm, 17 cm, 20 cm,



Mathieu

AI-4-191-14

Needle Holder
14 cm, 17 cm, 20 cm,



Mathieu

AI-4-192-17

Needle Holder standard profile with interior
ratchet
17 cm, 20 cm, 23 cm,



Toennis

AI-4-193-18

Needle Holder
18.5 cm,



Lichtenberg
AI-4-194-20

Needle Holder lightweight model standard profile
20 cm,



Langenbeck
AI-4-195-18

Needle Holder
18 cm, 20.5 cm, 23 cm,



Zweifel
AI-4-196-20

Needle Holder with hinged ratchet standard profile
20.5 cm, 23 cm,



Reverdin
AI-4-197-15

Reverdin Needle short
14.5 cm Fig. 1, 14.5 cm Fig. 2, 14.5 cm Fig. 3, 14.5 cm Fig. 4,

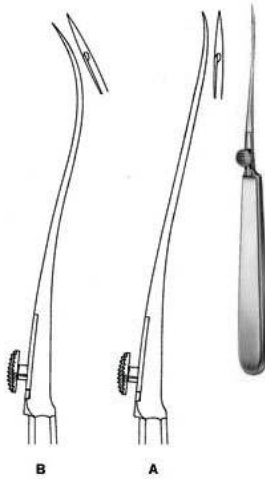

Reverdin
AI-4-198-19

Reverdin Needle medium
19.5 cm Fig. 1, 19.5 cm Fig. 2, 19.5 cm Fig. 3, 19.5 cm Fig. 4,

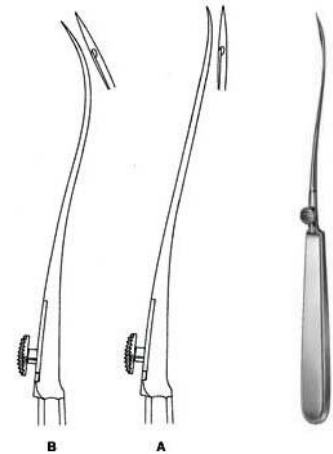

Reverdin
AI-4-199-23

Reverdin Needle long
23 cm Fig. 1, 23 cm Fig. 2, 23 cm Fig. 3, 23 cm Fig. 4,

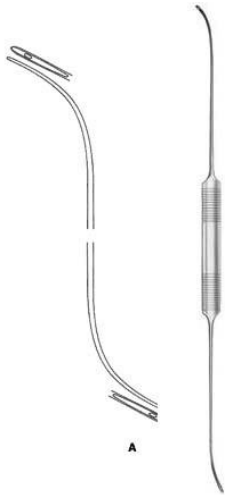

Schmieden-Dick
AI-4-201-01
Ligature Needle malleable
29 cm,

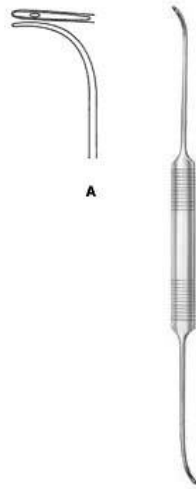

Schmieden
AI-4-202-21
Ligature Needle
24 cm,



AI-4-203-20
Ligature Needle malleable
20.5 cm,

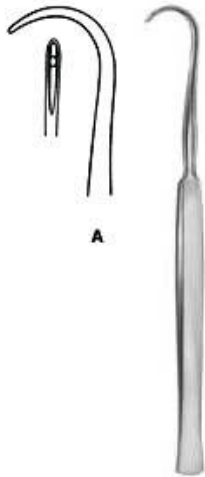

Cooper
AI-4-204-19
Ligature Needle
18.5 cm,



Kronecker
AI-4-205-13
Ligature Needle delicate for right hand
12.5 cm,

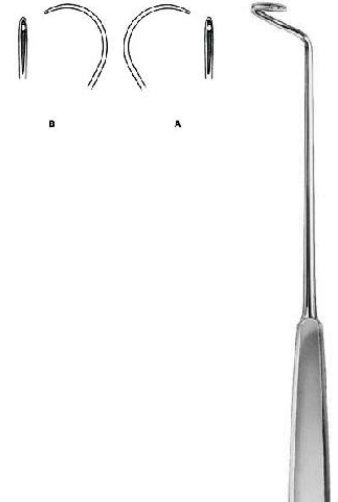

Deschamps
AI-4-206-24
Ligature Needle blunt for right hand
24 cm,

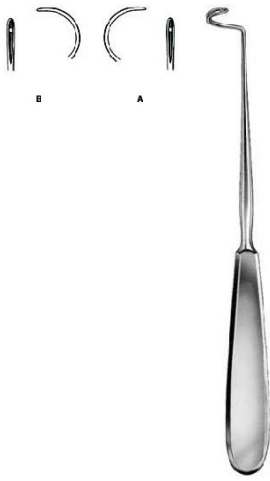

Deschamps
AI-4-207-20

Ligature Needle blunt for right hand
20 cm,



Deschamps
AI-4-208-20

Ligature Needle sharp for right hand
20 cm,

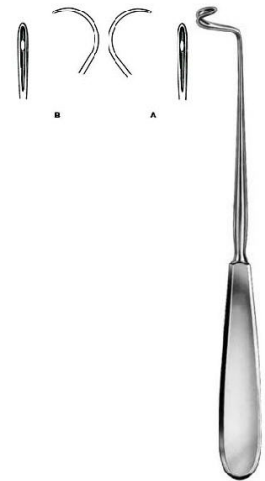

Deschamps
AI-4-209-21

Ligature Needle blunt for right hand
20 cm,

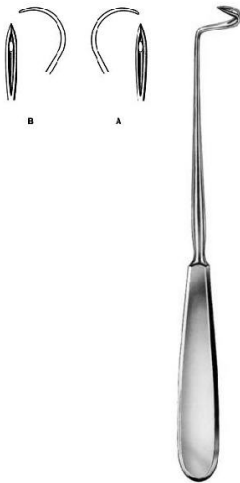

Deschamps
AI-4-210-21

Ligature Needle sharp for right hand
20 cm,

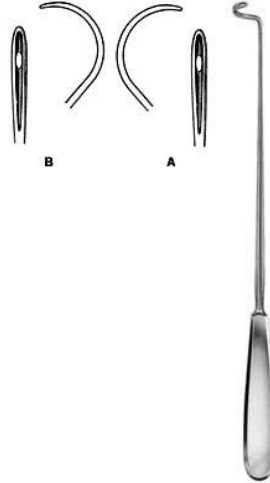

Deschamps
AI-4-211-27

Ligature Needle blunt for right hand
27 cm,

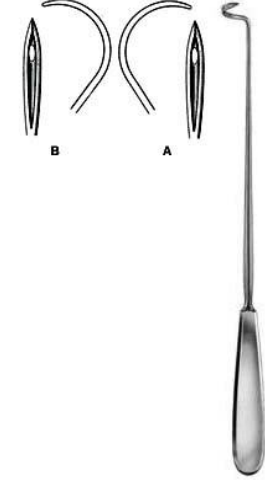

Deschamps
AI-4-212-27

Ligature Needle sharp for right hand
27 cm,

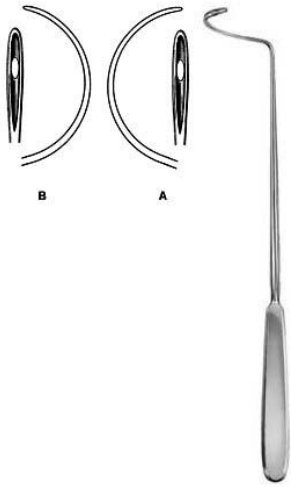

Deschamps
AI-4-213-28

Ligature Needle blunt for right hand
28 cm,

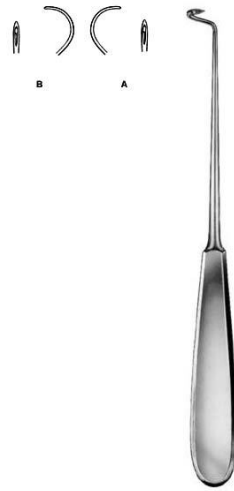

Deschamps
AI-4-214-20

Ligature Needle sharp for right hand
20 cm,



Deschamps
AI-4-215-20

Ligature Needle blunt for right hand
20 cm,



Deschamps
AI-4-216-20

Ligature Needle blunt for right hand
21 cm,

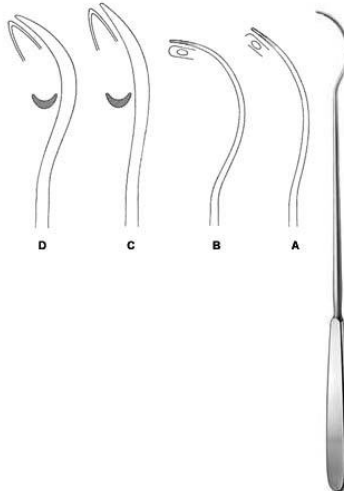

Brunner
AI-4-217-30
Ligature Needle
21 cm,



Kirschner
AI-4-218-25
Ligature Conductor
25.5 cm,

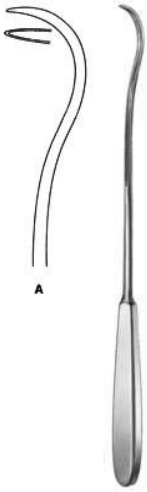

AI-4-219-28
Ligature Conductor
28 cm,



Modell Wien
AI-4-220-23
Ligature Catcher
23.5 cm,



Michel
AI-4-221-12
Clip Applying Forceps
12 cm,



Hegenbarth
AI-4-222-12
Clip Applying Forceps
12 cm,



AI-5-101-01

Dissecting Knife with metal handle
15 cm, 15.5 cm, 16 cm, 17 cm,



AI-5-102-10

Autopsy Knife
25.5 cm,

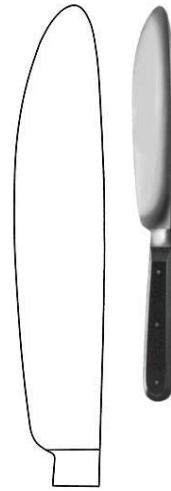

Walb

AI-5-104-17
Post Mortem Knife

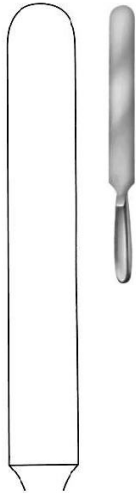

Virchow

AI-5-105-20

Brain Knife with hollow handle
28.5 cm, 33.5 cm, 38 cm,



AI-5-108-04

Scalpel Handle solid
13.5 cm,



AI-5-109-34

Scalpel Handle
16 cm,



AI-5-110-41
Scalpel Handle solid, long
21 cm,



AI-5-111-45
Scalpel Handle
21 cm,



Collin
AI-5-112-08
Scalpel Handle with hollow handle
13.5 cm,



Collin
AI-5-113-09
Scalpel Handle with hollow handle
14.5 cm,



AI-5-114-03
Scalpel Handle solid
12 cm,



AI-5-115-04
Scalpel Handle
12 cm,



AI-5-116-05
Scalpel Handle
12 cm,



AI-5-117-31
Scalpel Handle solid, long
21.5 cm,



AI-5-118-35
Scalpel Handle
21 cm,



AI-5-119-07
Scalpel Handle solid
16 cm,



AI-5-120-71
Scalpel Handle solid short
12.5 cm,



AI-5-121-03
Scalpel Handle with round hollow handle
15.5 cm,



AI-5-127-16

Amputation Knife with hollow handle
29 cm,



AI-5-128-19

Amputation Knife with hollow handle
32.5 cm,



Catlin

AI-5-129-16

Interosseous Knife with hollow handle
29cm,



AI-5-130-06

Resection Knife solid handle, dissecting end
18 cm,



Langenbeck

AI-5-131-05

Resection Knife
18 cm,



Langenbeck

AI-5-132-05

Resection Knife
18 cm,



AI-5-133-00

Razor Knife hollow blades on both sides cutting length 75mm



Schink

AI-5-134-00

Dermatome complete with 2 skin fixing plates and one blade 31 cm,



Schink

AI-5-135-01

Spare Blade spare blade for KE-05-134-00



Schink

AI-5-136-02

Skin Fixing Plate for KE-05-134-00



Standard BL / BL Straight
AI-5-201-13

Operating Scissor Special Price: \$1.25
12 cm, 13 cm, 14.5 cm, 16.5 cm, 18.5 cm, 20.5 cm,



Standard SH / BL STR
AI-5-202-13

Operating Scissors
12 cm, 13 cm, 14.5 cm, 16.5 cm, 18.5 cm, 20.5 cm,



Standard SH / SH STR
AI-5-204-13

Operating Scissors
12 cm, 13 cm, 14.5 cm, 16.5 cm,



Standard BL / BL Curved
AI-5-205-13

Operating Scissors
12 cm, 13 cm, 14.5 cm, 16.5 cm, 18.5 cm, 20.5 cm,



Standard SH / BL Curved
AI-5-206-13

Operating Scissors
12 cm, 13 cm, 14.5 cm, 16.5 cm, 18.5 cm, 20.5 cm,



Standard SH / SH Curved
AI-5-207-13

Operating Scissors
12 cm, 13 cm, 14.5 cm, 16.5 cm,



Standard BL / BL Curved
AI-5-208-14
Operating Scissors delicate
14.5 cm,



Incision Scissor
AI-5-209-14
Operating Scissor
14.5 cm,



Deaver
AI-5-210-14
Operating Scissors



Mayo
AI-5-211-15
Dissecting Scissors
14.5 cm, 15 cm, 17 cm, 23.5 cm, 14.5 cm, 15
cm, 17 cm, 23.5 cm,



Mayo
AI-5-212-23
Dissecting Scissors
23 cm, 22.5 cm, 28 cm,



Mayo-Harrington
AI-5-213-22
Dissecting Scissors
23 cm, 22.5 cm, 28 cm,

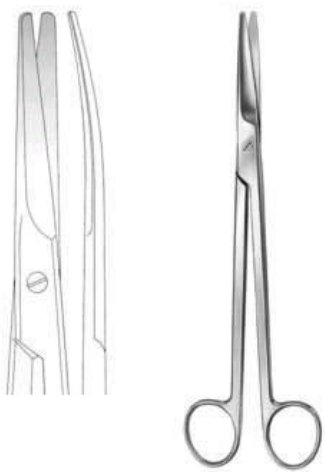

Mayo-Harrington
AI-5-214-22
Dissecting Scissors cur.
22.5 cm, 28 cm, 23 cm,

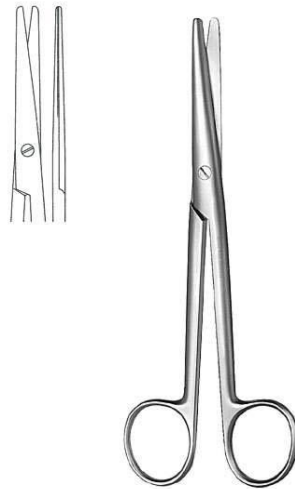

Mayo-Stille
AI-5-215-17
Dissecting Scissors str.
15 cm, 17 cm,

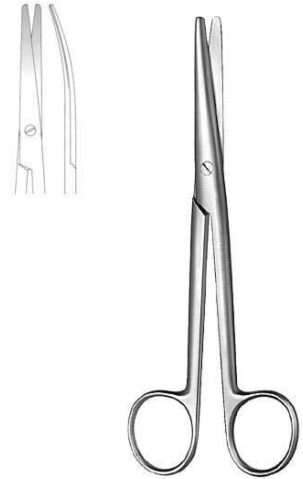

Mayo-Stille
AI-5-216-15
Dissecting Scissors cur.
15 cm, 17 cm,

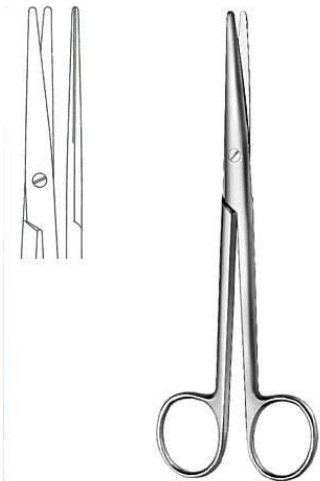

Mayo-Stille
AI-5-217-19
Dissecting Scissors str.
16 cm, 19.5 cm, 21.5 cm,

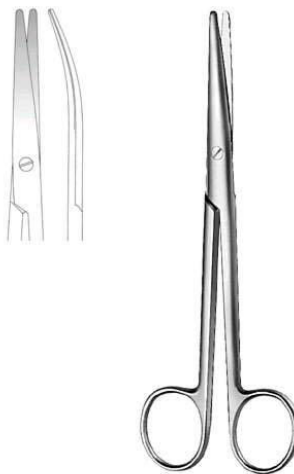

Mayo-Stille
AI-5-218-16
Dissecting Scissors cur.
16 cm, 19.5 cm, 21.5 cm,



Mayo-Noble
AI-5-219-17
Gynecological Scissors
16.5 cm,



Sims

AI-5-220-23

Gynecological Scissors str.
20 cm, 23 cm,



Sims

AI-5-221-20

Gynecological Scissors cur.
20 cm, 23 cm,



Kelly

AI-5-222-16

Operating Scissors
16 cm,



Doyen

AI-5-223-17

Gynecological Scissors
18.5 cm,



Sims-Siebold

AI-5-224-24

Gynecological Scissors
24.5 cm,



Sims-Siebold

AI-5-225-24

Gynecological Scissors
24.5 cm,



Wertheim
AI-5-226-23
Gynecological Scissors
20 cm, 23 cm,



Metzenbaum
AI-5-227-11
Dissecting Scissors
11.5 cm,



Metzenbaum
AI-5-228-14
Dissecting Scissors
14.5 cm,



Metzenbaum
AI-5-229-15
Dissecting Scissors
15.5 cm,



Metzenbaum-Nelson
AI-5-230-20
Dissecting Scissors
18 cm, 20.5 cm, 23 cm, 26 cm, 28.5 cm, 31 cm,



Metzenbaum-Nelson
AI-5-231-20
Dissecting Scissors
18 cm, 20.5 cm,



Metzenbaum-Nelson

AI-5-232-20

Dissecting Scissors

18 cm, 20.5 cm, 23 cm, 26 cm, 28.5 cm, 31 cm,



Metzenbaum

AI-5-233-14

Dissecting Scissors toothed

14.5 cm,



Nerve Operating Scissor

AI-5-234-15

Dissecting Scissors

15.5 cm,

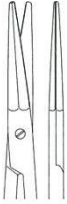

Gorney

AI-5-235-19

Face-lift Scissors str.

12.5 cm, 19.5 cm,

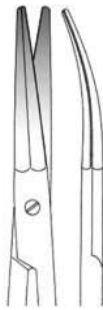

Gorney

AI-5-236-19

Face-lift Scissors cur.

19.5 cm,



Aston

AI-5-237-17

Face-lift Scissors

17 cm,



Lexer
AI-5-238-16
Dissecting Scissors
16 cm,



Cinelli
AI-5-239-14
Nasal Scissors
11.5 cm, 14 cm,



Thorek
AI-5-240-19
Dissecting Scissors
18.5 cm,



Lexer-Baby
AI-5-241-10
Dissecting Scissors
10 cm,



Lexer-Fino
AI-5-242-16
Delicate Dissecting Scissors slender pattern
16.5 cm,



Metzenbaum-Fino
AI-5-243-14
Delicate Dissecting Scissors slender pattern
14.5 cm,



Metzenbaum-Fino
AI-5-244-14
Delicate Dissecting Scissors
14.5 cm,



Metzenbaum-Fino
AI-5-245-14
Delicate Dissecting Scissors
14.5 cm,



Metzenbaum-Fino
AI-5-246-14
Delicate Dissecting Scissors
14.5 cm,

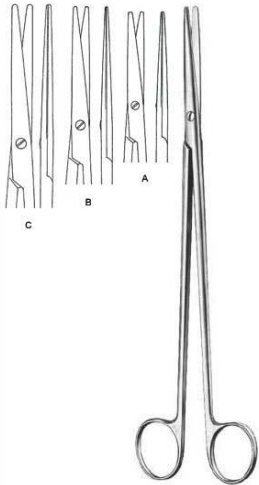

Metzenbaum-Fino
AI-5-247-18
Delicate Dissecting Scissors slender pattern
18 cm, 20 cm, 23 cm,

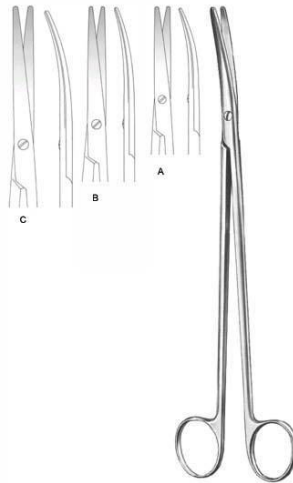

Metzenbaum-Fino
AI-5-248-18
Delicate Dissecting Scissors slender pattern
18 cm, 20 cm, 23 cm,

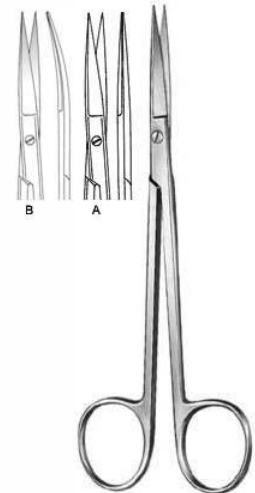

Sanvenero
AI-5-250-14
Operating Scissors
14 cm,

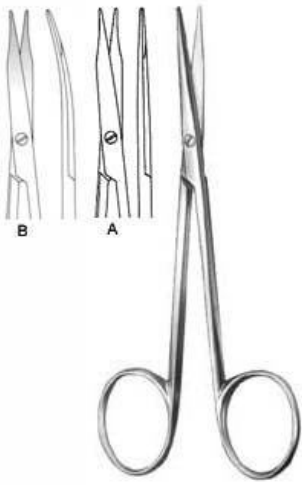

AI-5-251-11
Fine Operating Scissors
11.5 cm,

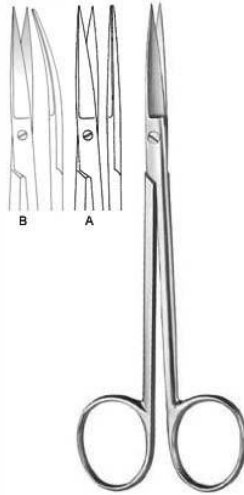

Joseph
AI-5-252-14
Operating Scissors
14.5 cm,

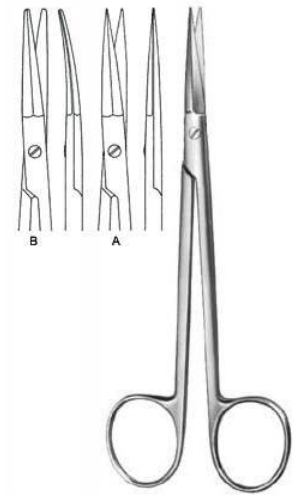

Peck-Joseph
AI-5-253-14
Face-lift Scissors
14.5 cm,

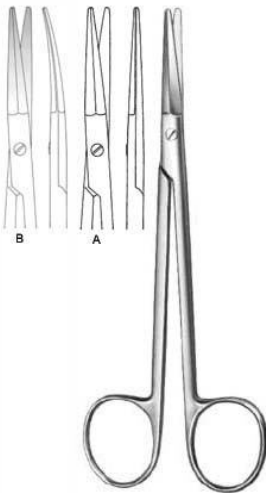

Peck-Joseph
AI-5-254-14
Face-lift Scissors
14.5 cm,



Shea Vein Graft
AI-5-255-12
Dissecting Scissors
12 cm,

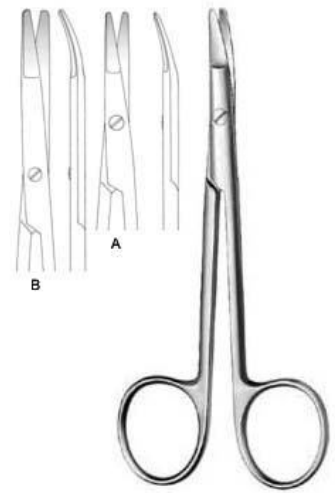

Kilner
AI-5-256-12
Dissecting Scissors
12 cm, 15 cm,

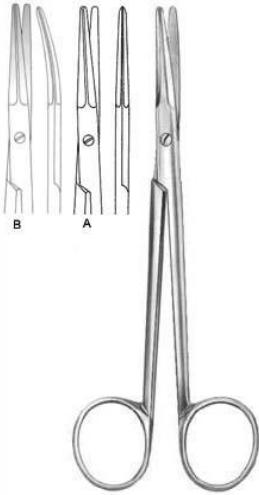

AI-5-257-14
Dissecting Scissors
14.5 cm,

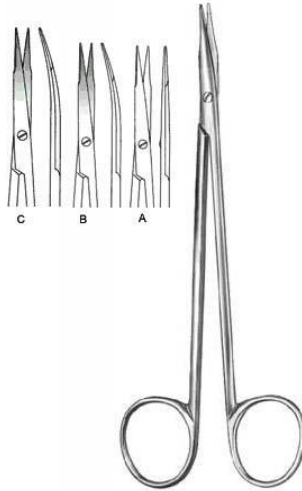

Reynolds
AI-5-258-15
Dissecting Scissors
15.5 cm, 18 cm,



Jameson
AI-5-259-14
Dissecting Scissors
15.5 cm,



Jameson
AI-5-260-14
Dissecting Scissors
15.5 cm,



AI-5-261-19
Vascular Scissors
19 cm,



AI-5-262-24
Vascular Scissors fine, short blades
19 cm, 25.5 cm,

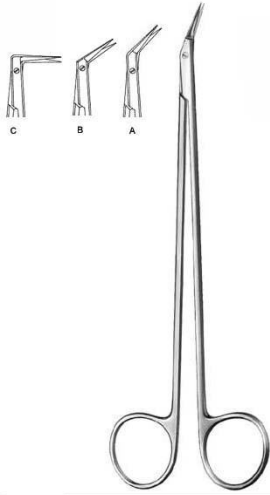

Diethrich

AI-5-263-25

Vascular Scissors
19 cm, 18.5 cm, 17.5 cm,

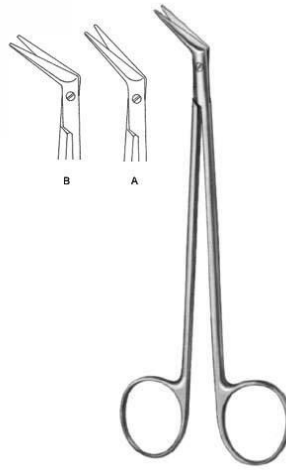

DeBakey

AI-5-264-45

Vascular Scissors
16.5 cm, 16 cm,



Potts-Smith

AI-5-265-19

Vascular Scissors
18 cm, 18.5 cm, 19 cm,



Coronary Scissors

AI-5-266-25

Cardiovascular Surgery Scissor
18 cm,



Coronary Scissors

AI-5-267-45

Cardiovascular Surgery Scissors
18 cm,



Coronary Scissors

AI-5-268-60

Cardiovascular Surgery Scissor
18 cm,



Coronary Scissors
AI-5-269-90

Cardiovascular Surgery Scissor
18 cm,



Coronary Scissors
AI-5-270-00

Cardiovascular Surgery Scissor
18 cm,



Coronary Scissors
AI-5-271-00

Cardiovascular Surgery Scissor
18 cm,



Coronary Scissors
AI-5-272-25

Cardiovascular Surgery Scissor
18 cm,



Coronary Scissors
AI-5-273-45

Cardiovascular Surgery Scissor
18 cm,



Coronary Scissors
AI-5-274-90

Cardiovascular Surgery Scissor
18 cm,



Schmieden-Taylor
AI-5-275-17
 Dura Scissors
 15 cm,



Strully
AI-5-276-22
 Neurosurgical Scissors
 22.5 cm,



Toennis-Adson
AI-5-277-17
 Dissecting Scissors
 17.5 cm,



Good
AI-5-279-19
 Tonsil Scissors
 19.5 cm,



Fomon
AI-5-282-15
 Nasal Scissors
 15 cm,



Cottle
AI-5-283-16
 Nasal Scissors
 16 cm,



Heymann
AI-5-284-18
Nasal Scissors
18.5 cm,



Heymann
AI-5-285-18
Nasal Scissors
18.5 cm,



Converse
AI-5-286-11
Nasal Scissors blunt & sharp
10.5 cm,



Waldmann
AI-5-287-18
Episiotomy Scissors
18 cm,



Braun-Stadler
AI-5-288-14
Episiotomy Scissors
14.5 cm,



Braun-Stadler
AI-5-289-22
Episiotomy Scissors
22 cm,



Modell USA
AI-5-290-10
Umbilical Scissors
10.5 cm,



Busch
AI-5-292-16
Umbilical Scissors
16 cm,



Goldmann-Fox
AI-5-293-13
Gum Scissors
13 cm,



Wagner
AI-5-294-12
Operating Scissors
12 cm,

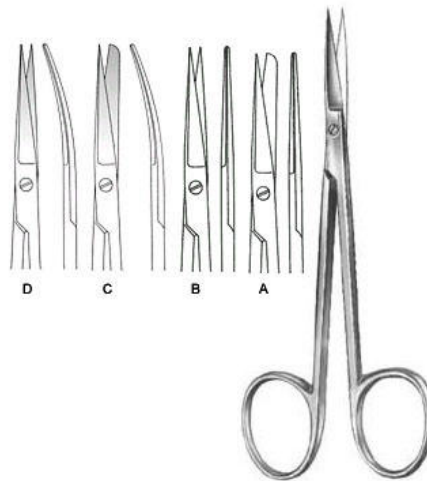

AI-5-295-12
Operating Scissors small model
12 cm,



La Grange
AI-5-296-11
Gum Scissors S-shaped
11.5 cm,



AI-5-297-11
Dissecting Scissors delicate
11.5 cm,



Locklin
AI-5-298-16
Gum Scissors
16 cm,



Locklin
AI-5-299-16
Gum Scissors
16 cm,



AI-5-300-08
Operating Scissors very delicate
9 cm,

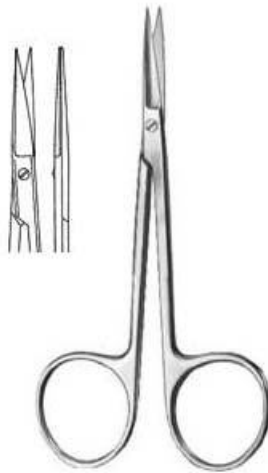

AI-5-301-10
Iris Scissors
9 cm, 10 cm,

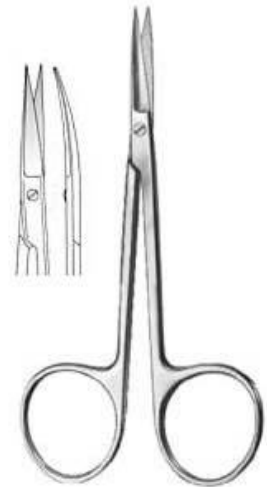

AI-5-302-10
Iris Scissors extra flat blades
10 cm,



AI-5-303-10
Iris Scissors extra flat blades
10 cm,



Bonn
AI-5-304-09
Iris Scissors



Dean
AI-5-278-17
Tonsil Scissors
17.5 cm,



Spencer Scissor
AI-0-

Dressing & Tissue Forceps



Standard

AI-5-401-10

Dressing Forceps

10.5 cm, 11.5 cm, 13 cm, 14.5 cm, 16 cm, 18 cm, 20 cm, 23 cm, 25 cm, 30.5 cm,



Standard

AI-5-402-11

Dressing Forceps

12 cm, 13 cm, 14.5 cm, 16 cm, 18 cm, 20 cm, 25 cm, 30 cm,



AI-5-403-13

Dressing Forceps

13 cm, 14.5 cm,



Stille

AI-5-404-15

Dressing Forceps

15 cm,



Mini-Adson

AI-5-405-12

Dressing Forceps

12 cm,



Adson

AI-5-406-12

Dressing Forceps

12 cm, 15 cm,

Dressing & Tissue Forceps



McIndoe
AI-5-407-15
Dressing Forceps
15 cm,



Waugh
AI-5-408-20
Dressing Forceps
20 cm,



Semken
AI-5-409-12
Dressing Forceps
12.5 cm, 15 cm,



Taylor
AI-5-410-17
Dressing Forceps
12.5 cm, 15 cm,



Taylor
AI-5-411-17
Dressing Forceps
17 cm,



Taylor
AI-5-412-17
Dressing Forceps
18.5 cm,

Dressing & Tissue Forceps



AI-5-413-06
Micro Dressing Forceps
15.5 cm,



Gerald
AI-5-414-18
Dressing Forceps
15.5 cm,



Cushing
AI-5-415-17
Dressing Forceps
17.5 cm,



Potts-Smith
AI-5-416-18
Dressing Forceps
18 cm, 21 cm, 24.5 cm,



Bonney
AI-5-417-17
Dissecting Forceps
17.5 cm,



Gerald
AI-5-418-17
Dissecting Forceps
17.5 cm,

Dressing & Tissue Forceps



Gillies
AI-5-419-15
Dissecting Forceps
15.5 cm,



McIndoe
AI-5-420-15
Dressing Forceps
15 cm,



Semken
AI-5-421-16
Dissecting Forceps
15.5 cm, 17.5 cm,



Adson-Brown
AI-5-422-12
Dissecting Forceps
12 cm,



Adson
AI-5-423-12
Dissecting Forceps
12 cm, 15 cm,



Adson
AI-5-424-12
Dressing Forceps
12 cm, 15 cm,

Dressing & Tissue Forceps



Cushing
AI-5-425-17
Dressing Forceps
17.5 cm,



Cushing
AI-5-426-18
Dressing Forceps
17 cm,



Cushing-Taylor
AI-5-427-18
Dressing Forceps
18.5 cm,



Potts-Smith
AI-5-428-15
Dressing Forceps
16 cm, 18.5 cm, 20 cm, 23 cm, 25 cm,



Oehler
AI-5-429-14
Dissecting Forceps
14.5 cm, 16 cm, 18 cm, 20 cm, 25 cm,



Wangensteen
AI-5-430-15
Dressing Forceps
15 cm, 23 cm,

Dressing & Tissue Forceps



DeBakey
AI-5-431-15

Atraumatic Dressing Forceps
16 cm, 20 cm, 24.5 cm, 16 cm, 20 cm, 24.5 cm,



DeBakey
AI-5-432-16

Atraumatic Dressing Forceps
16 cm, 20 cm, 24 cm,

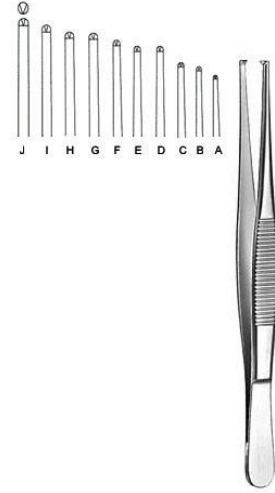

AI-5-433-10

Dissecting Forceps
10.5 cm, 11.5 cm, 13 cm, 14.5 cm, 16 cm, 18 cm, 20 cm, 23 cm, 25 cm, 30.5 cm,

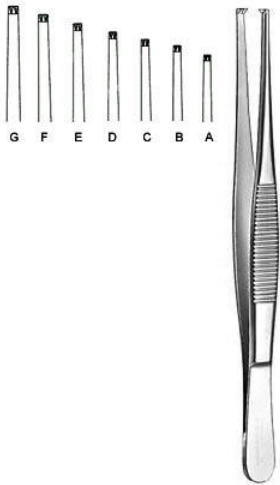

AI-5-434-11

Dissecting Forceps
12 cm, 13 cm, 14.5 cm, 15.5 cm, 18 cm, 20 cm, 24.5 cm,



AI-5-435-14

Dissecting Forceps
14.5 cm, 16 cm,



AI-5-436-14

Dissecting Forceps
14.5 cm, 16 cm,



AI-5-437-13
Dissecting Forceps
13 cm, 14.5 cm, 16 cm, 20 cm,



AI-5-438-13
Dissecting Forceps
13 cm, 14.5 cm,



Stille
AI-5-439-15
Dissecting Forceps
15 cm,



Stille
AI-5-440-15
Dissecting Forceps
15 cm,



Stone
AI-5-441-15
Dissecting Forceps
15 cm,



Lerche
AI-5-442-15
Dissecting Forceps
15 cm,

Dressing & Tissue Forceps

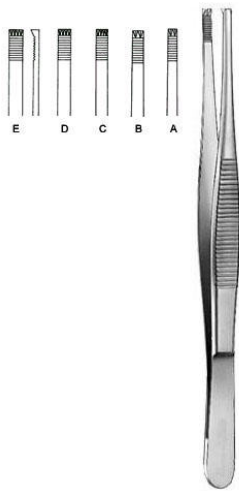

Adlerkreutz
AI-5-443-15

Dissecting Forceps
15.5 cm, 20.5 cm, 16 cm, 20 cm, 25 cm,

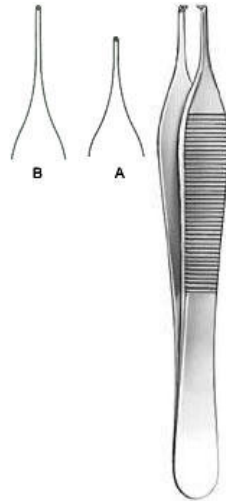

Adson

AI-5-444-12

Dissecting Forceps
12 cm, 15 cm,



Gillies

AI-5-445-15

Dissecting Forceps
15.5 cm,



Waugh

AI-5-446-20

Dissecting Forceps
20.5 cm,



Semken

AI-5-447-12

Dissecting Forceps
12.5 cm, 15 cm,



Taylor

AI-5-448-17

Dissecting Forceps
17.5 cm,

Dressing & Tissue Forceps



Taylor
AI-5-449-17
Dissecting Forceps
17 cm,



Taylor
AI-5-450-17
Dissecting Forceps
18.5 cm,



AI-5-451-06
Micro Dissecting Forceps
15.5 cm,



Gerald
AI-5-452-17
Dissecting Forceps
17.5 cm,



Cushing
AI-5-453-17
Dissecting Forceps
18 cm,



Potts-Smith
AI-5-454-18
Dissecting Forceps
18 cm, 21 cm, 24 cm,

Dressing & Tissue Forceps

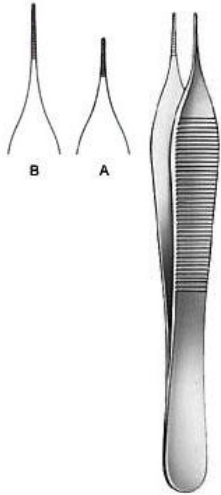

Mikro-Adson
AI-5-455-12
Dressing Forceps
12 cm, 15 cm,

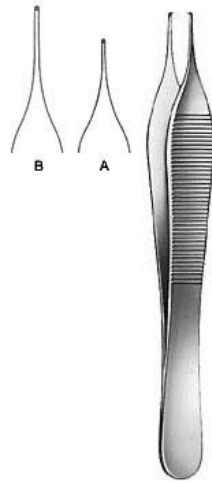

Mikro-Adson
AI-5-456-12
Dissecting Forceps
12 cm, 15 cm,



AI-5-457-11
Dissecting Forceps
10.5 cm,



Micro Jewelers
AI-5-458-12
Jeweler Type Forceps
12 cm Fig. 7,



Jewelers
AI-5-459-12
Jeweler Type Forceps
12 cm Fig. 3,



Jewelers
AI-5-460-11
Jeweler Type Forceps
11 cm Fig. 3c,

Dressing & Tissue Forceps



Jewelers
AI-5-461-11
Jeweler Type Forceps
11 cm Fig. 5,



Jewelers
AI-5-462-11
Jeweler Type Forceps
11 cm Fig. 4,



Stille-Barraya
AI-5-463-18
Dissecting Forceps
18 cm,



Bonney
AI-5-464-18
Dissecting Forceps
17.5 cm,



Nelson
AI-5-465-23
Dissecting Forceps
23 cm,



AI-5-466-10
Dressing Forceps
10 cm, 9.5 cm,

Dressing & Tissue Forceps



AI-5-467-12
Splinter Forceps smooth jaw
12.5 cm,



AI-5-468-12
Splinter Forceps smooth jaw
12.5 cm,



AI-5-469-12
Splinter Forceps
12.5 cm,



AI-5-470-12
Splinter Forceps
12.5 cm,



AI-5-471-16
Micro Tying Forceps
15.5 cm,



AI-5-472-10
Microscopic Forceps super light, blunt
10 cm,

Dressing & Tissue Forceps



AI-5-473-10
Microscopic Forceps
10 cm,



Shaaf
AI-5-474-09
Splinter Forceps
9.5 cm,



Littauer
AI-5-475-08
Cilia Forceps
8.5 cm,



AI-5-476-09
Cilia Forceps
8.5 cm,



Douglas
AI-5-477-09
Cilia Forceps
9 cm,



Douglas
AI-5-478-09
Cilia Forceps
9 cm,



Beer
AI-5-479-09
Cilia Forceps
9 cm,

Splinter Forceps



Phaneuf
AI-5-501-21
Hysterectomy Forceps
20.5 cm,



Wertheim-Cullen
AI-5-502-21
Vaginal Clamp
21 cm,

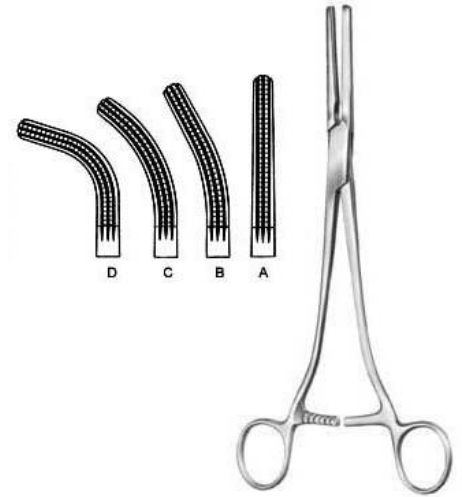

Rogers
AI-5-503-10
Hysterectomy Forceps
21.5 cm Fig. 1, 21 cm Fig. 2, 20.5 cm Fig. 3, 20 cm Fig. 4,



Moynihan
AI-5-504-23
Hysterectomy Forceps
23 cm,



Moynihan
AI-5-505-24
Hysterectomy Forceps
23.5 cm,



Wertheim
AI-5-506-25
Hysterectomy Forceps
26 cm,

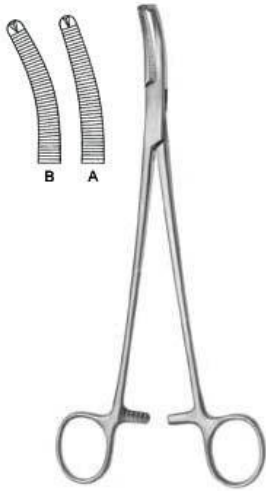

Wertheim
AI-5-507-22
Hysterectomy Forceps
22.5 cm,



Mikulicz, Baby
AI-5-508-14
Peritoneum Forceps
14.5 cm,



Mikulicz
AI-5-509-18
Peritoneum Forceps
20.5 cm,



Mikulicz
AI-5-510-20
Peritoneum Forceps
18.5 cm,



Mikulicz
AI-5-511-20
Peritoneum Forceps
20 cm,



Mikulicz
AI-5-512-21
Peritoneum Forceps
20.5 cm,



Faure
AI-5-513-20
Peritoneum Forceps
21 cm,

Haemostatic Forceps

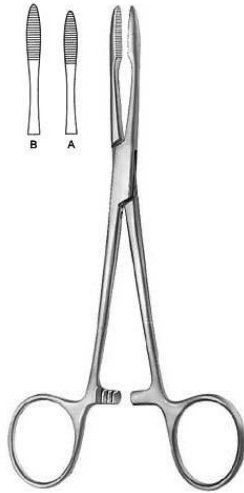

Pean

AI-5-601-14

Haemostatic Forceps
14.5 cm, 16 cm,

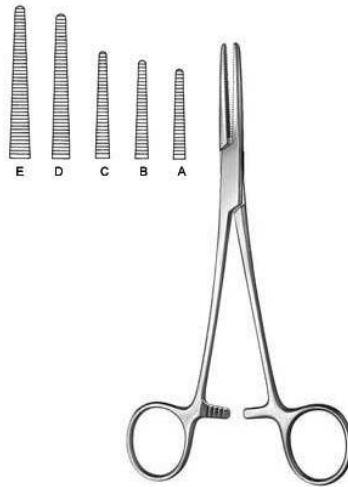

Spencer-Wells

AI-5-602-13

Haemostatic Forceps
13 cm, 14 cm, 15.5 cm, 18.5 cm, 20 cm,

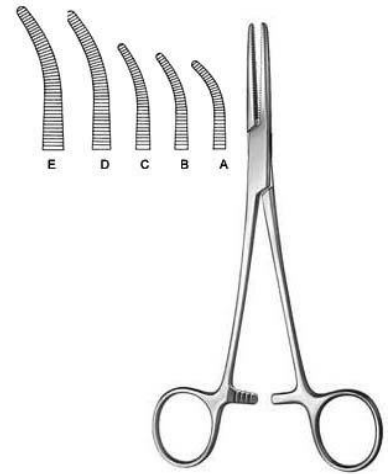

Spencer-Wells

AI-5-603-13

Haemostatic Forceps
13 cm, 14 cm, 15 cm, 18 cm, 20 cm,



Chaput

AI-5-604-13

Haemostatic Forceps
12.5 cm,



Tuffier

AI-5-605-13

Haemostatic Forceps
12.5 cm,

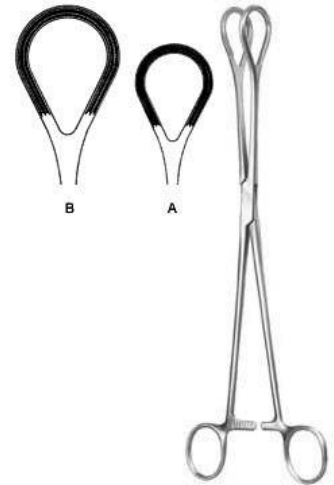

AI-5-606-25

Organ Grasping Forceps

Haemostatic Forceps



Collin

AI-5-607-14

Organ Grasping Forceps
15.5 cm, 21 cm,



Collin

AI-5-608-17

Tumor Grasping Forceps
17 cm,



Pennington

AI-5-609-15

Haemostatic Forceps
15.5 cm,



Pratt

AI-5-610-15

Haemostatic Forceps
15 cm,



Martel-Rees

AI-5-611-14

Face-lift Forceps
13.5 cm,



AI-5-612-12

Ligature Forceps

Haemostatic Forceps

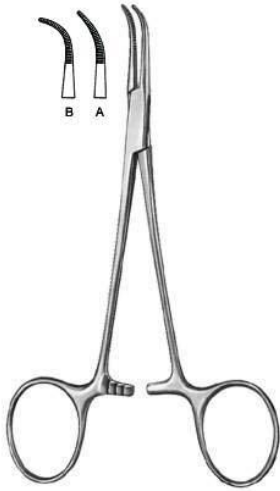

Mixer-Baby
AI-5-613-01

Dissecting and Ligature Forceps
13.5 cm, 13 cm,

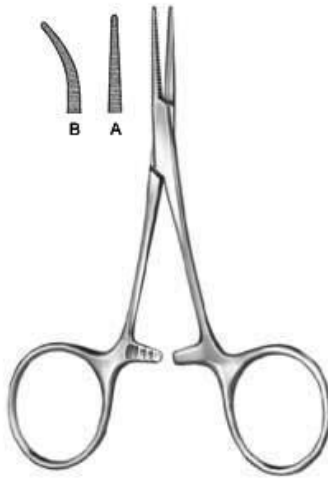

Hartmann
AI-5-614-10

Haemostatic Forceps
10 cm, 9.5 cm,



AI-5-615-12
Ligature Forceps

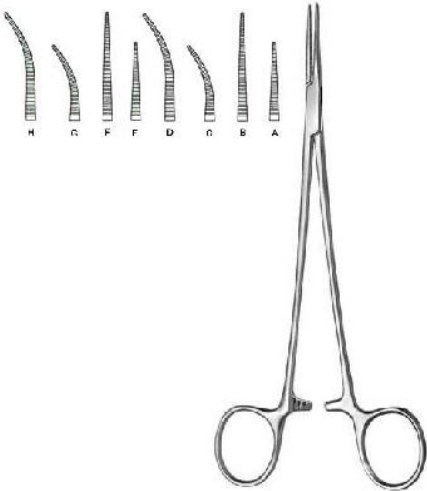

Halsted-Mosquito
AI-5-616-18

Haemostatic Forceps
12.5 cm, 14.5 cm, 14 cm,

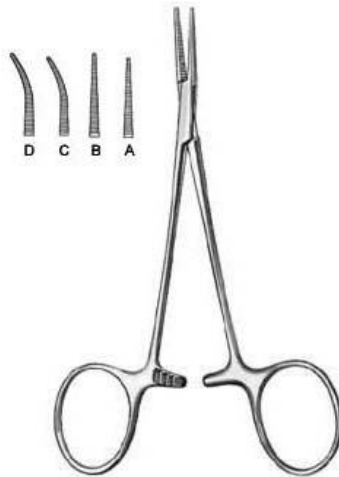

Mikro-Mosquito
AI-5-617-10

Haemostatic Forceps
10 cm, 12 cm, 9.5 cm, 11.5 cm,



Providence-Hospital
AI-5-618-14

Haemostatic Forceps
14 cm,

Haemostatic Forceps



Leriche

AI-5-619-15

Haemostatic Forceps
15.5 cm, 15 cm,

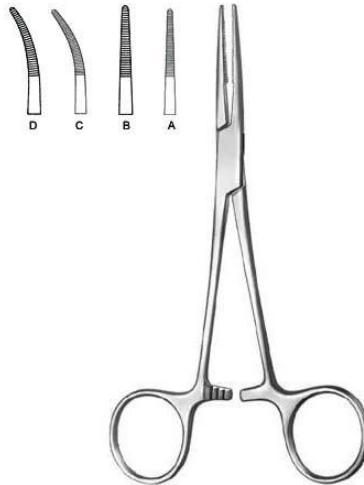

Kelly

AI-5-620-14

Haemostatic Forceps
14.5 cm, 14 cm,

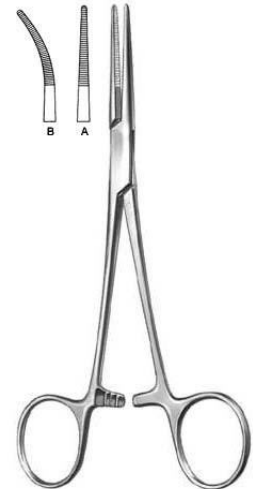

Kelly-Rankin

AI-5-621-16

Haemostatic Forceps
16 cm, 15.5 cm,



Overholt-Baby

AI-5-622-14

Dissecting and Ligature Forceps
14.5 cm, 14 cm,



Crile

AI-5-623-14

Haemostatic Forceps
14.5 cm, 14 cm,



Crile-Rankin

AI-5-624-16

Haemostatic Forceps
16.5 cm, 16 cm,

Haemostatic Forceps

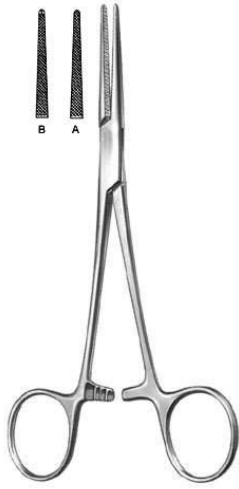

Lovelace
AI-5-625-15
Haemostatic Forceps
16 cm,



Dandy-Mosquito
AI-5-626-12
Haemostatic Forceps
12 cm,

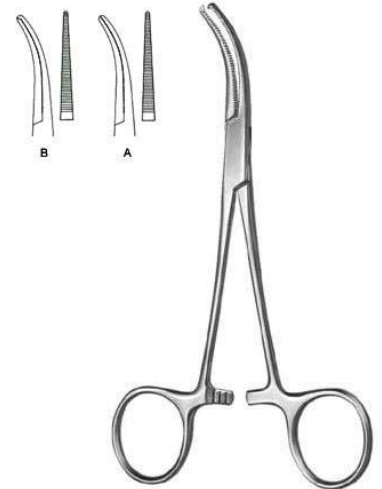

Dandy
AI-5-627-14
Haemostatic Forceps
14.5 cm, 14 cm,



Schnidtt
AI-5-628-18
Dissecting and Ligature Forceps
18.5 cm, 19 cm,



Adson
AI-5-629-18
Dissecting and Ligature Forceps
19 cm, 18.5 cm,



Martin-Fuchsig
AI-5-630-20
Dissecting and Ligature Forceps
20.5 cm,

Haemostatic Forceps

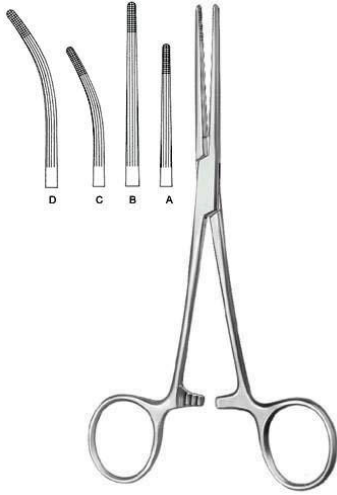

Rochester-Carmalt

AI-5-631-16

Haemostatic Forceps
17 cm, 20.5 cm, 16.5 cm, 20 cm,

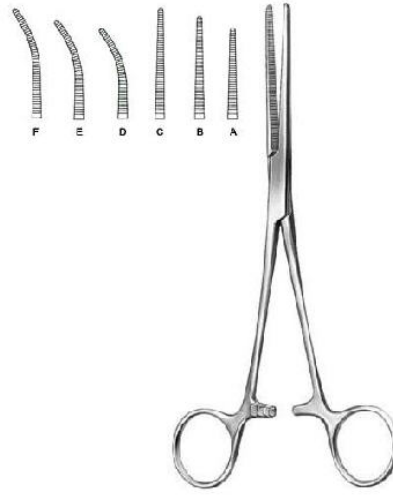

Pean

AI-5-632-13

Haemostatic Forceps
13.5 cm, 14.5 cm, 17 cm, 13 cm, 14 cm, 16.5 cm,

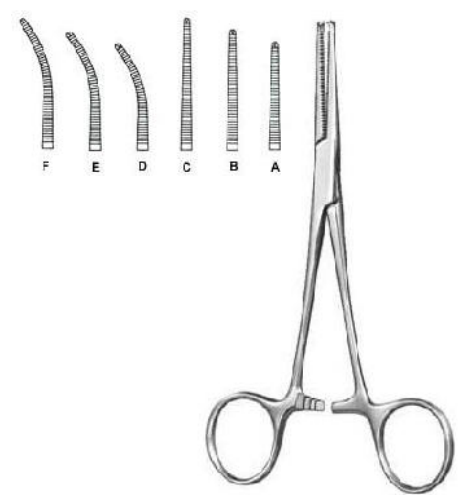

Kocher-Nippon

AI-5-633-14

Haemostatic Forceps
14.5 cm, 16.5 cm, 18.5 cm, 16 cm, 18 cm,

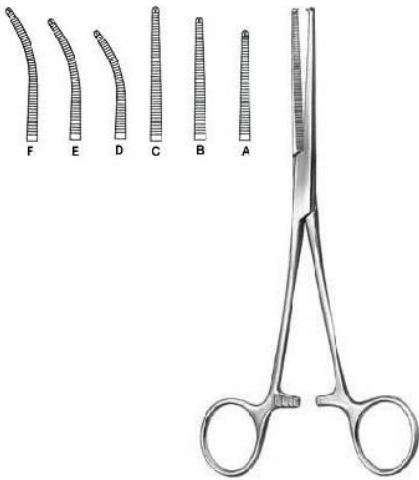

Kocher

AI-5-635-13

Haemostatic Forceps
13 cm, 14 cm, 16 cm,

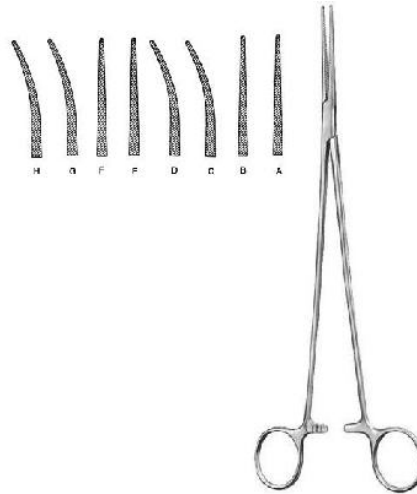

Bengolea

AI-5-636-20

Haemostatic Forceps
21.5 cm, 26 cm, 21 cm, 21.5 cm,

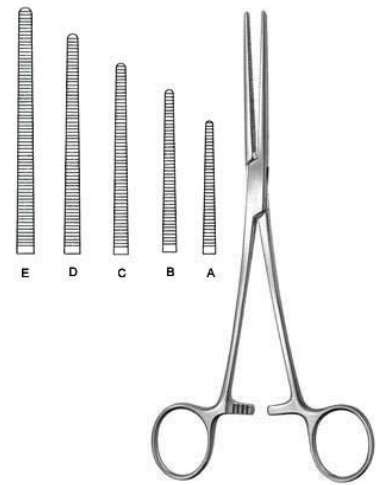

Pean (Rochester)

AI-5-637-14

Haemostatic Forceps
14.5 cm, 16.5 cm, 18.5 cm, 20.5 cm, 22.5 cm, 24.5 cm, 26 cm, 30.5 cm, 14 cm, 16 cm,

Haemostatic Forceps

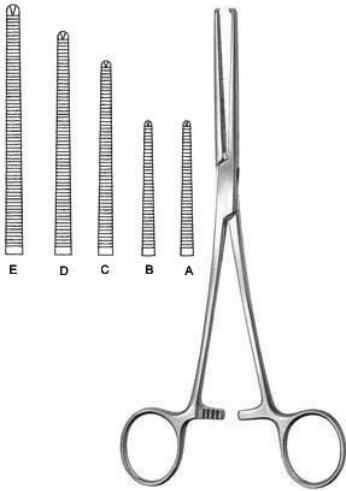

Kocher (Ochsner)
AI-5-638-14

Haemostatic Forceps
14.5 cm, 16.5 cm, 18.5 cm, 20.5 cm, 22.5 cm, 24.5 cm, 26 cm, 30.5 cm,

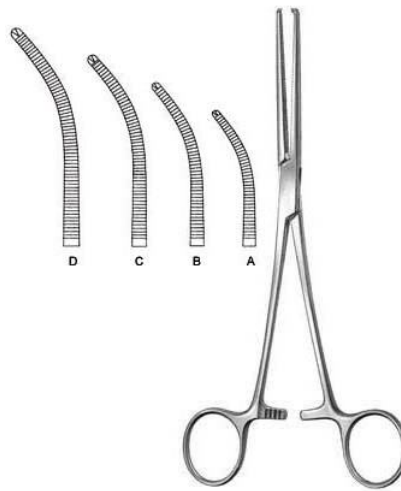

Kocher (Ochsner)
AI-5-639-14

Haemostatic Forceps
14 cm, 16 cm, 18 cm, 20 cm, 22 cm, 24 cm, 25.5 cm, 30 cm,

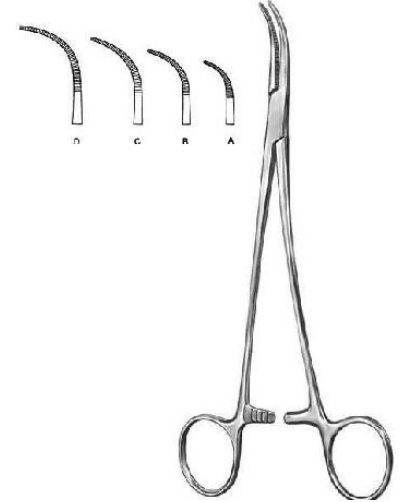

Overholt-Martin
AI-5-640-01

Dissecting and Ligature Forceps
18.5 cm Fig. 1, 20.5 cm Fig. 2, 21 cm Fig. 3, 21.5 cm Fig. 4, 24.5 cm Fig. 5,



Mixer-Baby
AI-5-641-18

Dissecting and Ligature Forceps
18.5 cm,



Adson-Baby
AI-5-642-14

Dissecting and Ligature Forceps
14.5 cm, 18 cm,



Heiss
AI-5-643-20

Dissecting and Ligature Forceps
21 cm, 20.5 cm, 20 cm,

Haemostatic Forceps



Overholt-Mixter
AI-5-644-21

Dissecting and Ligature Forceps
21.5 cm,

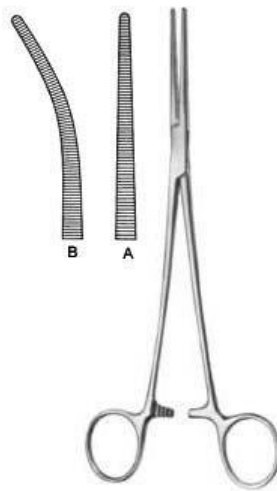

Roberts

AI-5-645-22

Dissecting and Ligature Forceps
22.5 cm, 21.5 cm,

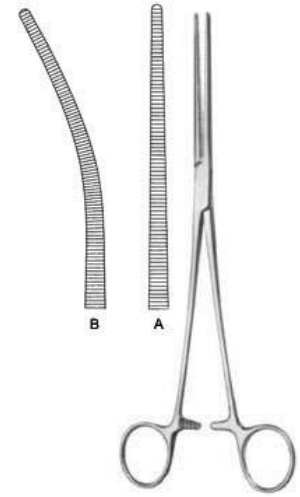

Sarot

AI-5-646-24

Dissecting and Ligature Forceps
25 cm, 24.5 cm,

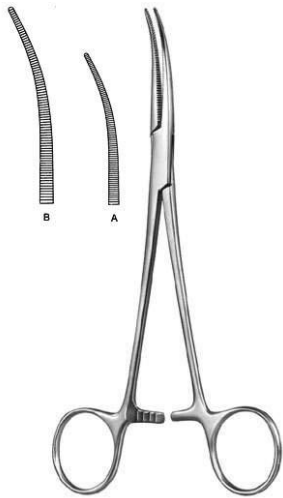

Crafoord

AI-5-647-18

Dissecting and Ligature Forceps
18 cm, 24.5 cm,

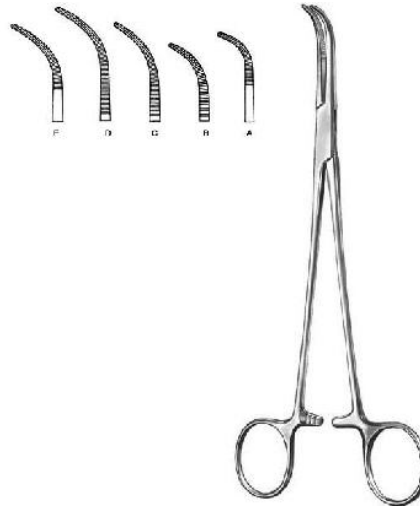

Overholt-Geissendorfer

AI-5-648-01

Dissecting and Ligature Forceps
20.5 cm Fig. 1, 20 cm Fig. 2, 21.5 cm Fig. 3, 22 cm Fig. 4, 21.5 cm Fig. 5, 22 cm Fig. 6, 27 cm Fig. 1, 26.5 cm Fig. 2, 27.5 cm Fig. 3, 28 cm Fig. 4,

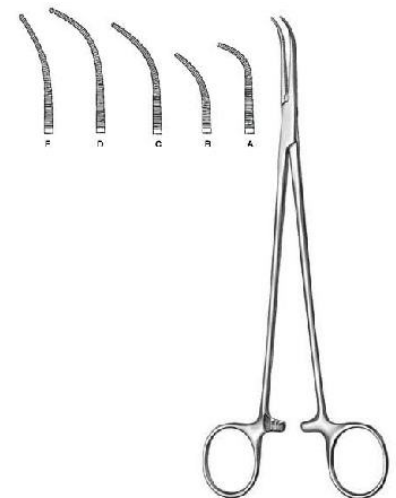

Overholt-Fino

AI-5-649-00

Dissecting and Ligature Forceps
21.5 cm, 21 cm, 22 cm, 23 cm, 22.5 cm,

Haemostatic Forceps

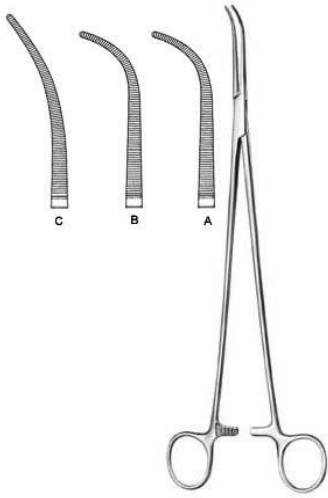

Overholt
AI-5-650-00

Dissecting and Ligature Forceps
29.5 cm, 30 cm,



Overholt-Mini
AI-5-651-01

Dissecting and Ligature Forceps
15 cm, 20 cm,

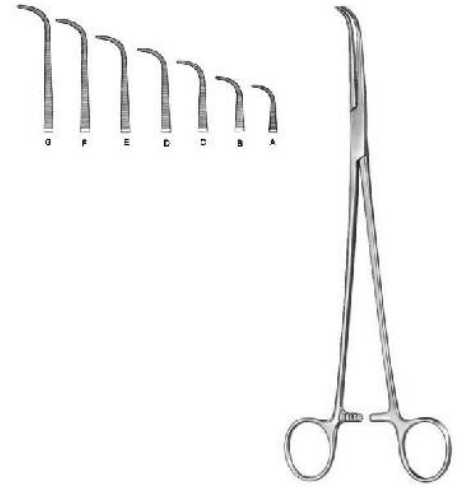

Gemini
AI-5-652-13

Dissecting and Ligature Forceps
13 cm, 16 cm, 18 cm, 21 cm, 23 cm, 25 cm, 28 cm,

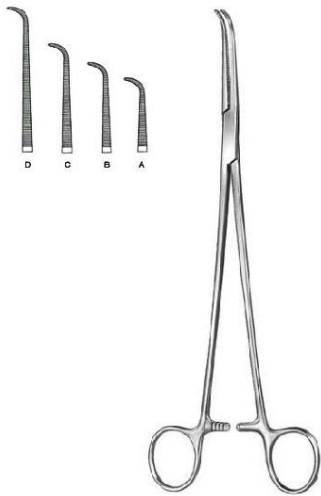

Mini-Gemini
AI-5-653-18

Dissecting and Ligature Forceps
18 cm, 22.5 cm, 25 cm, 28.5 cm,

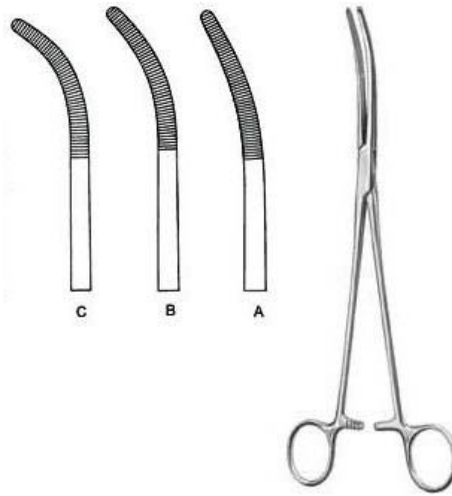

Rumel
AI-5-654-01

Dissecting and Ligature Forceps
24 cm Fig. 1, 23.5 cm Fig. 2, 23 cm Fig. 3, 24 cm Fig. 4, 23.5 cm Fig. 5,

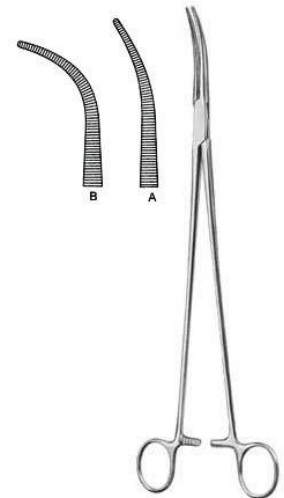

Zenker
AI-5-655-01

Dissecting and Ligature Forceps
29.5 cm, 28.5 cm,

Haemostatic Forceps



Mixer-Baby
AI-5-656-14

Dissecting and Ligature Forceps
13.5 cm,



Mixer

AI-5-657-15

Dissecting and Ligature Forceps
16 cm, 18 cm,



Mixer-O Shaughnessy

AI-5-658-19

Dissecting and Ligature Forceps
18 cm,



Mixer

AI-5-659-22

Dissecting and Ligature Forceps
22.5 cm,



Mixer

AI-5-660-23

Dissecting and Ligature Forceps
23 cm,

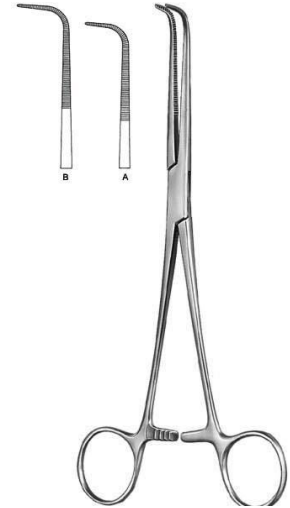

Wickstrom

AI-5-661-21

Dissecting and Ligature Forceps
21 cm, 24.5 cm,

Haemostatic Forceps

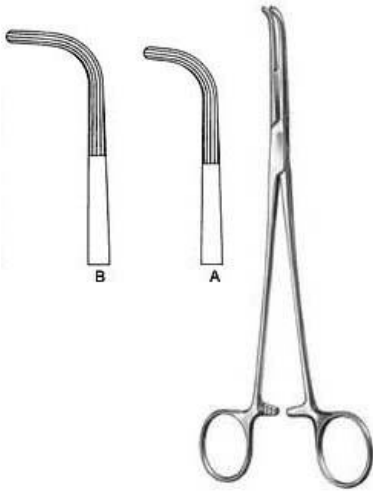

Mixer

AI-5-662-22

Dissecting and Ligature Forceps
22.5 cm, 26 cm, 28 cm,



Mc Quigg-Mixer

AI-5-663-22

Dissecting and Ligature Forceps
23.5 cm,



Lower

AI-5-664-18

Dissecting and Ligature Forceps
18.5 cm,

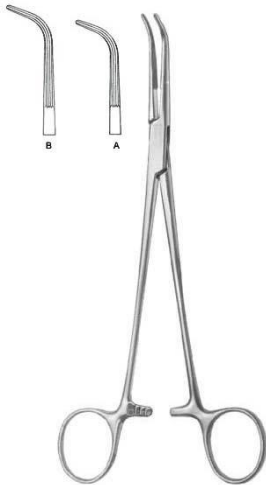

Lahey

AI-5-665-19

Bile Duct Clamp
19.5 cm, 22.5 cm,



Finochietto

AI-5-666-24

Dissecting and Ligature Forceps
24 cm,

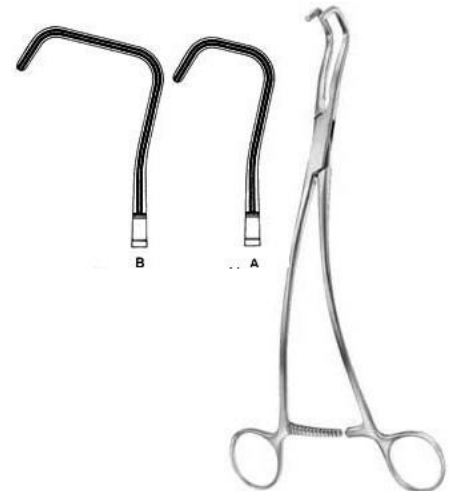

Uro-Tangential

AI-5-667-01

Tangential Forceps
25 cm, 27 cm,

Haemostatic Forceps

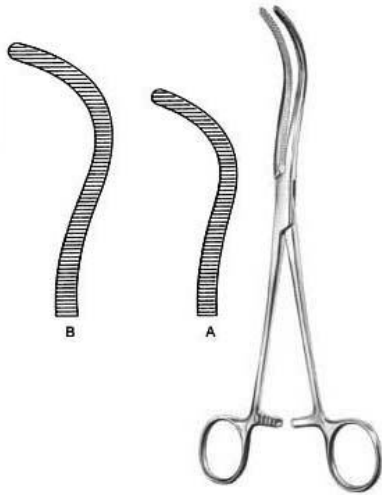

Guyon
AI-5-668-20
Kidney Pedicle Clamp
23 cm, 24 cm,



Guyon
AI-5-669-23
Kidney Pedicle Clamp
19.5 cm, 21.5 cm, 24 cm,



Desjardins
AI-5-670-21
Bile Duct Clamp
21 cm,

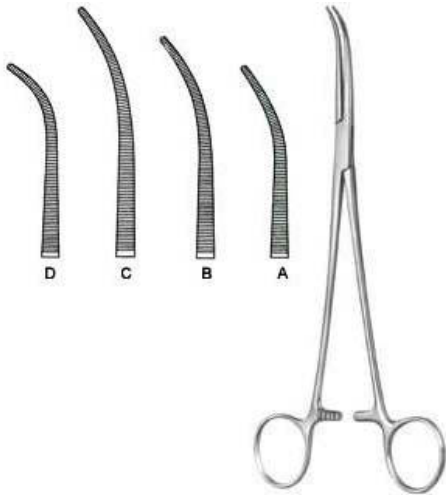

Kelly
AI-5-671-19
Dissecting and Ligature Forceps
19.5 cm Fig. 1, 22.5 cm Fig. 1, 24.5 cm Fig.
1, 19 cm Fig. 2, 22 cm Fig. 2, 24 cm Fig. 2, 18.5
cm Fig. 3, 21.5 cm Fig. 3, 23.5 cm Fig. 3,



Lawrence
AI-5-672-28
Dissecting and Ligature Forceps
28 cm,



Meeker
AI-5-673-28
Dissecting and Ligature Forceps
28 cm,

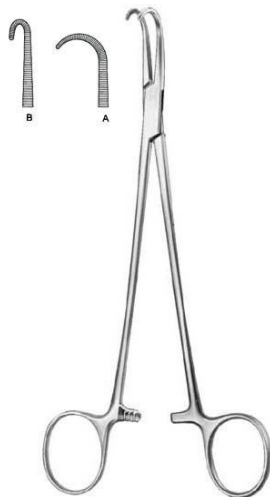

Negus

AI-5-674-19

Haemostatic Forceps
19.5 cm Fig. 1, 20 cm Fig. 2,

Towel & Tubing Clamps



Schaedel
AI-5-701-09
Towel Clamp sharp
9 cm,



Jones
AI-5-702-05
Towel Clamp sharp
5.5 cm, 8.5 cm,



Jones-Martin
AI-5-703-09
Towel Clamp sharp
8.5 cm,



Backhaus
AI-5-704-11
Towel Clamp
11.5 cm, 13 cm,



Backhaus
AI-5-705-11
Towel Clamp
11.5 cm,



Backhaus
AI-5-706-08
Towel Clamp
9 cm, 11.5 cm, 13 cm, 16 cm,

Towel & Tubing Clamps

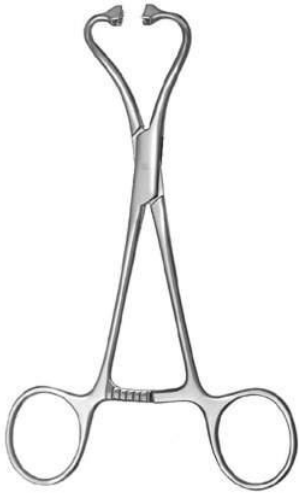

Peers-Bertram modif.

AI-5-707-15

Towel Clamp wide jaw for tube fixation
15.5 cm,



Roder

AI-5-708-13

Towel Clamp
13.5 cm,

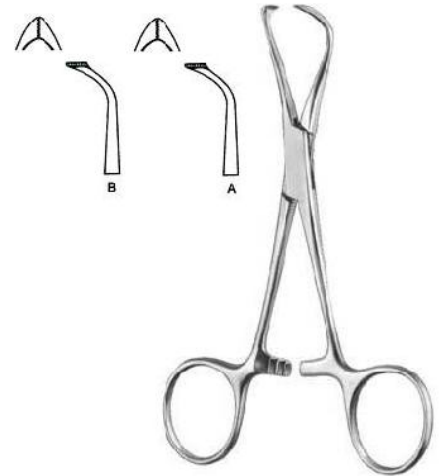

Lorna

AI-5-709-10

Towel Clamp fine serrated, wide jaw
9.5 cm, 13 cm,



Bernhard

AI-5-710-16

Towel Clamp
16.5 cm,

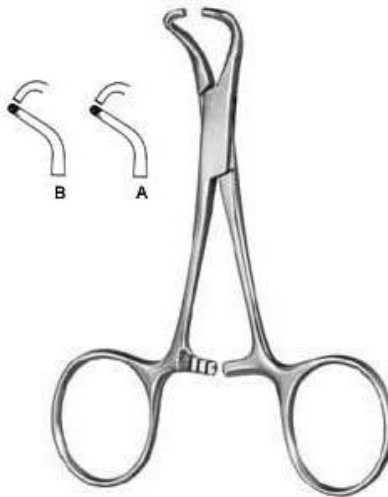

Tohoku

AI-5-711-10

Towel Clamp
10.5 cm blunt, 13.5 cm blunt, 14.5 cm,

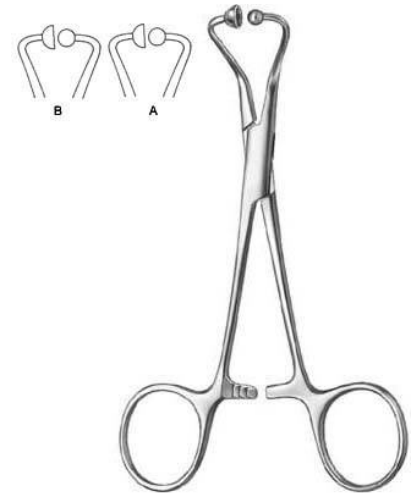

AI-5-712-11

Towel Clamp for paper clothes
11.5 cm, 14 cm,

Towel & Tubing Clamps



Lane
AI-5-713-20
Towel Clamp
19.5 cm,

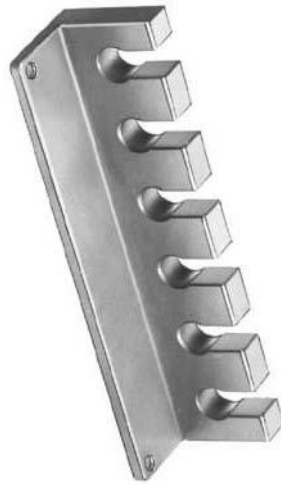

AI-5-714-06
Tube Holder for fixation of six tubes



AI-5-715-14
Tubing Clamp extra long ratchet
14 cm,



AI-5-716-16
Tubing Clamp
16.5 cm,

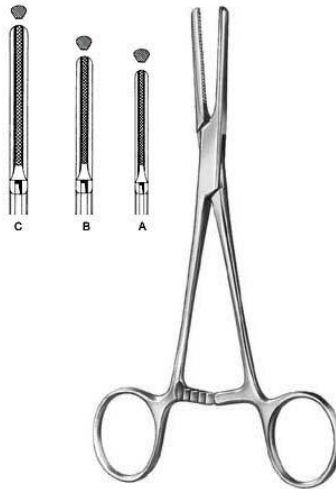

AI-5-717-15
Tubing Clamp
15.5 cm, 19 cm, 20.5 cm,

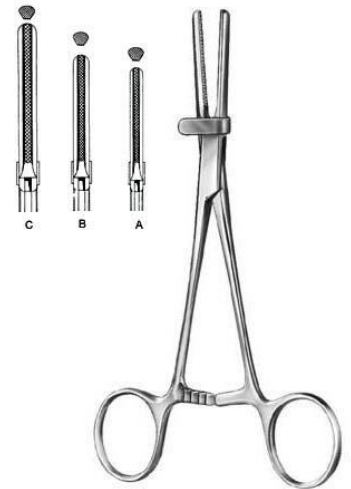

AI-5-718-15
Tubing Clamp with safety guard
15.5 cm, 19 cm, 20.5 cm,

Dressing & Sponge Forceps

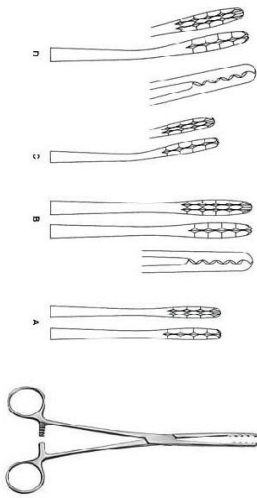

Ulrich

AI-5-801-22

Dressing Forceps
22.5 cm, 26.5 cm,



Lister

AI-5-802-13

Sinus Forceps
13 cm, 16 cm, 18 cm,



Martin

AI-5-803-17

Dressing Forceps
17.5 cm, 17 cm,

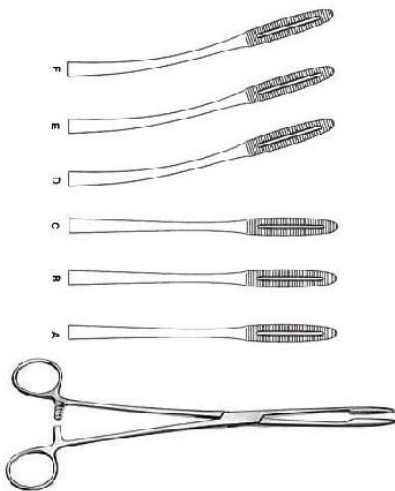

Gross-Maier

AI-5-804-20

Dressing Forceps
20.5 cm, 22 cm, 26.5 cm, 20 cm, 21.5 cm, 26 cm,



AI-5-805-40

Tunneling Forceps
39.5 cm,



Collin

AI-5-806-25

Dressing Forceps
25.5 cm,

Dressing & Sponge Forceps



Cheron
AI-5-807-25
Dressing Forceps
23.5 cm,



Bozemann
AI-5-808-26
Sponge Forceps
26 cm,

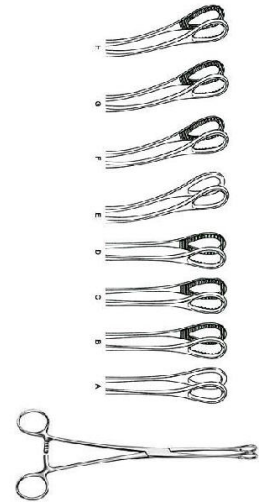

Foerster
AI-5-809-25
Sponge Forceps
25 cm, 18 cm, 20.5 cm, 24.5 cm, 17.5 cm, 20 cm, 24.5 cm,

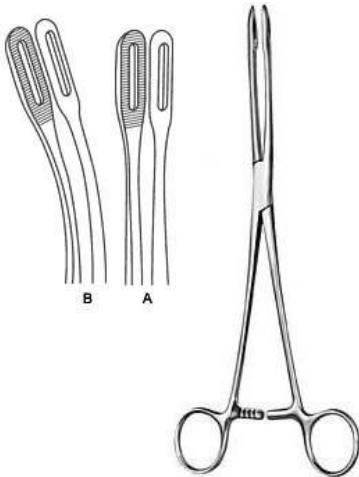

Foerster
AI-5-810-25
Sponge Forceps
25 cm, 24.5 cm,

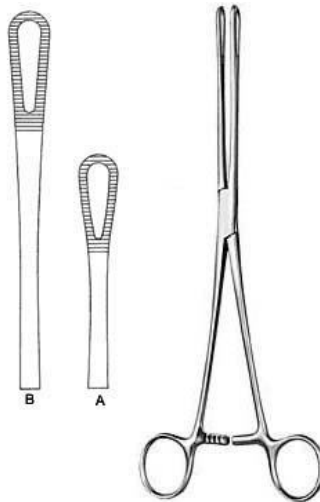

Rampley
AI-5-811-18
Sponge Forceps
18.5 cm, 24.5 cm,



Vickers
AI-5-901-18
Skin Hooklet
18.5 cm,



Vickers
AI-5-902-01
Bone Hooklet
17 cm,



Vickers
AI-5-903-01
Tendon Hooklet
17 cm,



Vickers
AI-5-904-02
Hooklet
16 cm,

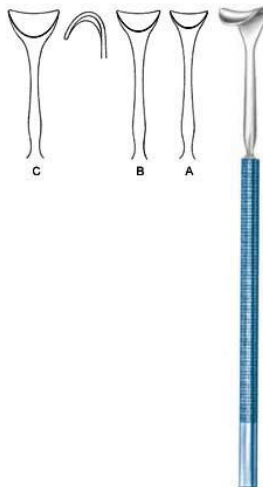

Vickers
AI-5-905-12
Saddle Hook
14 cm,



Graefe
AI-5-906-01
Micro Hooklet
15 cm,

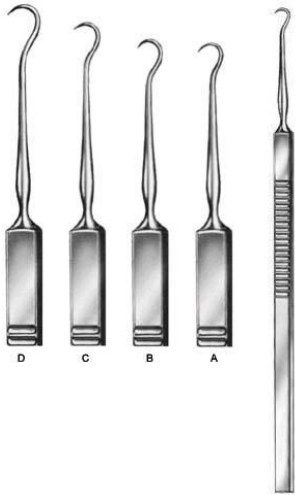

AI-5-907-01

Skin Hook

16 cm Fig. 1, 16 cm Fig. 2, 16 cm Fig. 3, 16 cm Fig. 4,



O Connor

AI-5-908-16

Skin Hook

16 cm,



Guthrie

AI-5-909-01

Skin Hook

15.5 cm,

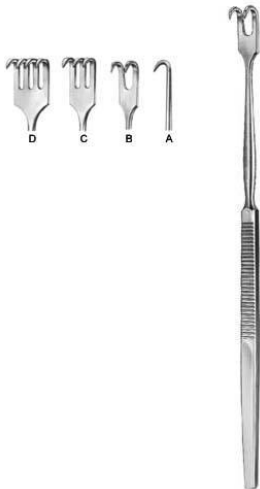

AI-5-910-01

Hooklet

16.5 cm,



AI-5-911-01

Hooklet

16.5 cm,



AI-5-912-02

Hooklet

16 cm,

Retractors



AI-5-913-04
Hooklet
16.5 cm,



AI-5-914-12
Vessel Hook
12 cm,

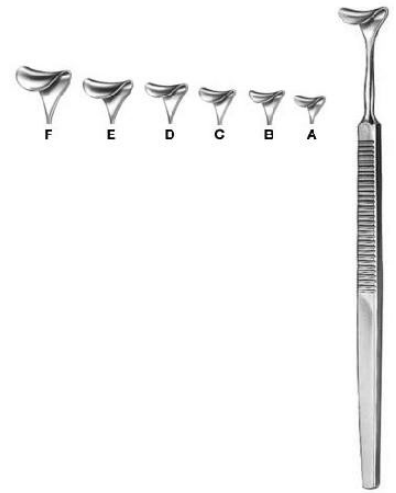

Desmarres
AI-5-915-08
Saddle Hook
16 cm 8 mm, 16 cm 10 mm, 16 cm 12 mm, 16 cm 14 mm, 16 cm 16 mm, 16 cm 18 mm,

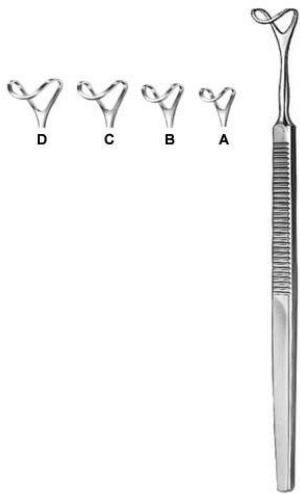

AI-5-916-12
Saddle Hook
16 cm 12 mm, 16 cm 14 mm, 16 cm 16 mm, 16 cm 18 mm,

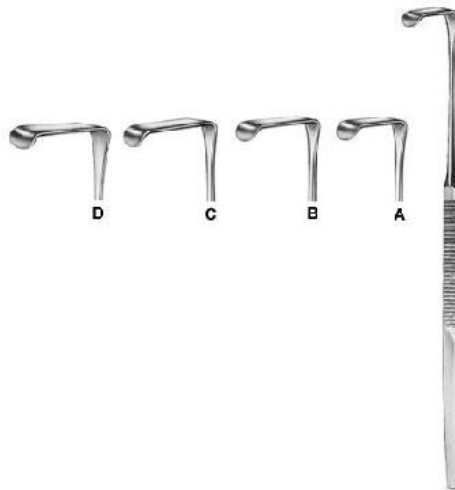

Langenbeck-Mini
AI-5-917-10
Hooklet
16 cm,



AI-5-918-16
Hooklet
16 cm 14 x 8,



AI-5-919-01
Hooklet
16.5 cm,



AI-5-920-01
Hooklet
16.5 cm,



Meyerding
AI-5-921-01
Hooklet
17.5 cm Fig. 1, 17.5 cm Fig. 2, 17.5 cm Fig. 3, 17.5 cm Fig. 4, 17.5 cm Fig. 5, 17.5 cm Fig. 6,



Senn-Green
AI-5-922-01
Hooklet
15 cm Fig. 1, 15 cm Fig. 2,



Ragnell-Davis
AI-5-923-14
Hooklet
14 cm,

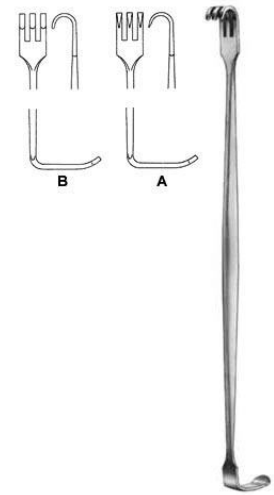

Senn-Miller
AI-5-924-16
Hooklet
16 cm,



Cushing
AI-5-925-20
Retractor
20.5 cm,



Cushing
AI-5-926-08
Saddle Hook
20.5 cm 8 mm wide, 20.5 cm 10 mm wide, 20.5 cm 12 mm wide, 20.5 cm 14 mm wide, 20.5 cm 16 mm wide, 20.5 cm 18 mm wide,

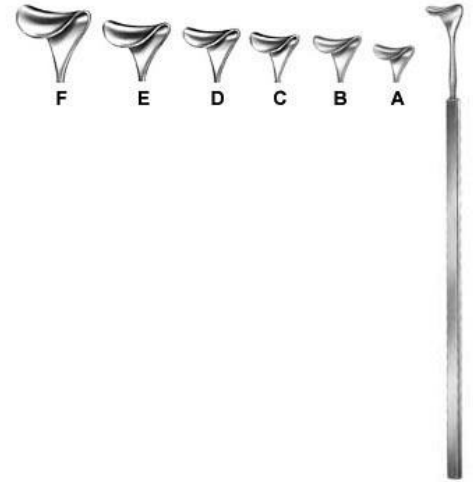

Cushing
AI-5-927-08
Saddle Hook 8 mm to 18 mm wide
24 cm,



Brom
AI-5-928-01
Vein Hook
19.5 cm,



Strandell-Stille
AI-5-929-01
Hooklet
19 cm Fig. 1, 19 cm Fig. 2,

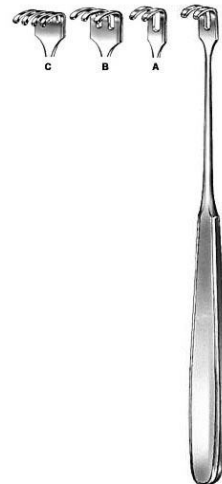

Klapp
AI-5-930-01
Retractor 12 x 6, 12 x 11, 15 x 11
17.5 cm,

Retractors



AI-5-931-04
Hooklet
16.5 cm,

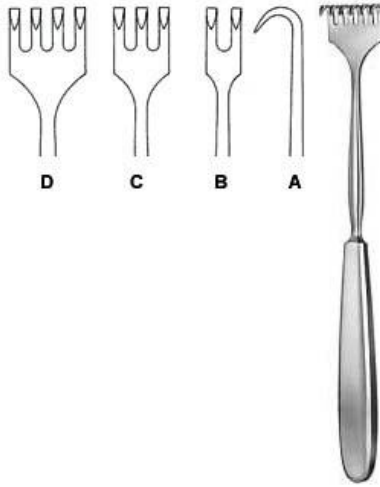

Volkmann
AI-5-932-01
Retractor
21.5 cm,

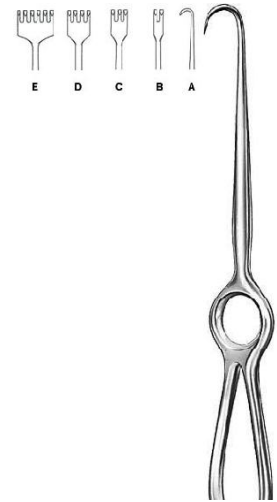

Volkmann
AI-5-933-01
Retractor
22 cm, 21.5 cm,

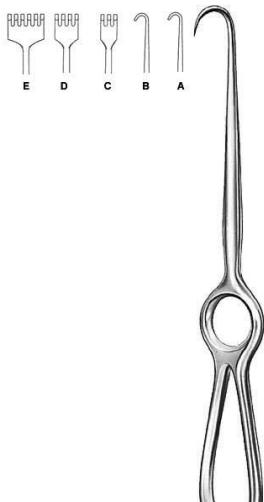

Kocher
AI-5-934-01
Retractor
22 cm,

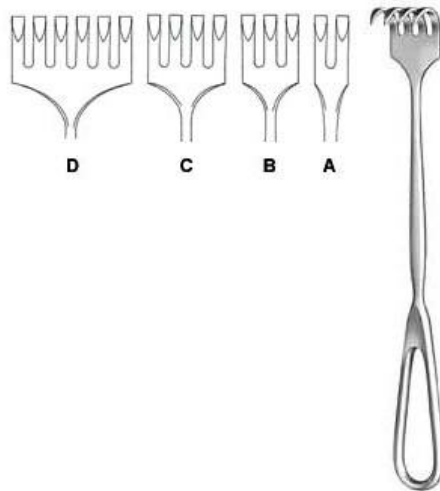

Martin
AI-5-935-02
Retractor
22.5 cm,

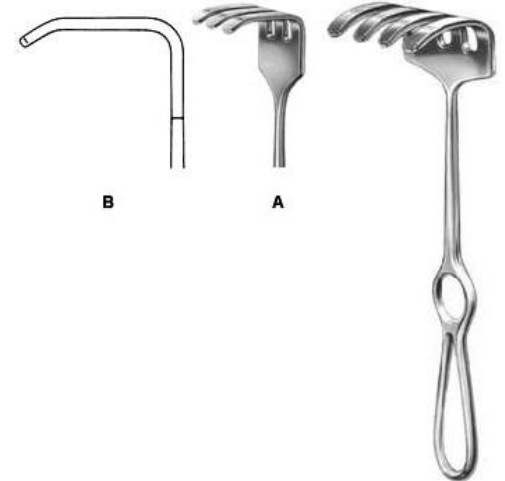

Ollier
AI-5-936-03
Retractor
23 cm 36 x 30, 23 cm 36 x 60,

Retractors

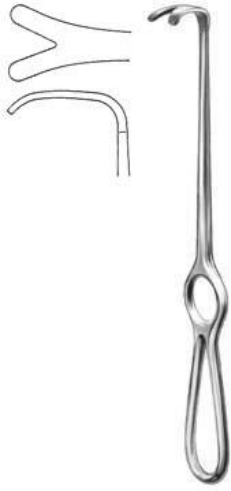

Wassmund
AI-5-937-02
Retractor
20.5 cm 33 x 21,

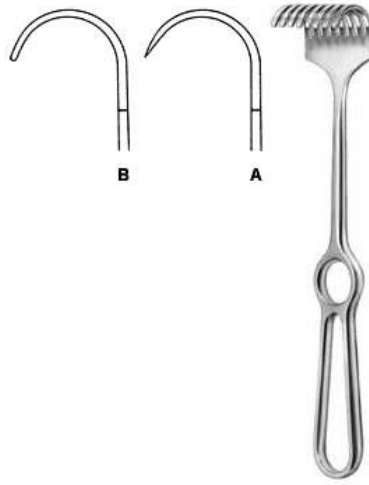

Korte
AI-5-938-08
Retractor
24.5 cm 40 x 30,

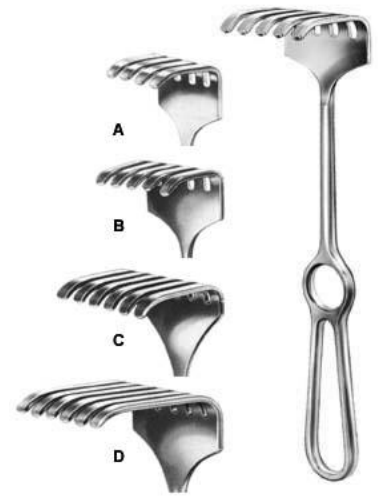

Israel
AI-5-939-04
Retractor
25.5 cm,

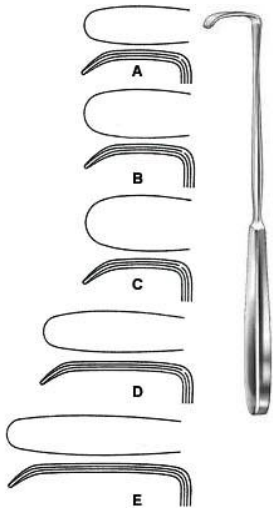

Langenbeck
AI-5-940-01
Retractor
22.5 cm 30 x 11 mm, 22.5 cm 30 x 14 mm, 22.5 cm 30 x 16 mm, 22.5 cm 40 x 11 mm, 22.5 cm 50 x 11 mm,

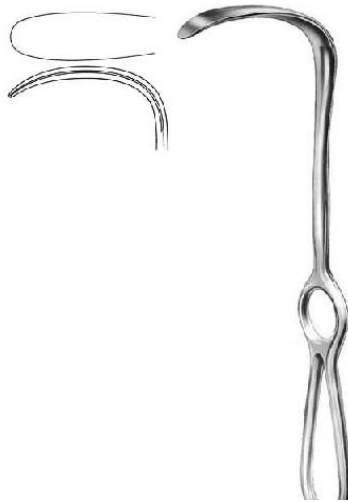

Langenbeck
AI-5-942-21
Retractor
21 cm 65 x 20 mm,



Langenbeck
AI-5-943-21
Retractor
22.5 cm 85 x 15 mm,

Retractors



Lahey
AI-5-944-19

Retractor
19.5 cm 36 x 19 mm,



Little
AI-5-945-20

Retractor
20 cm 13 x 15 mm,

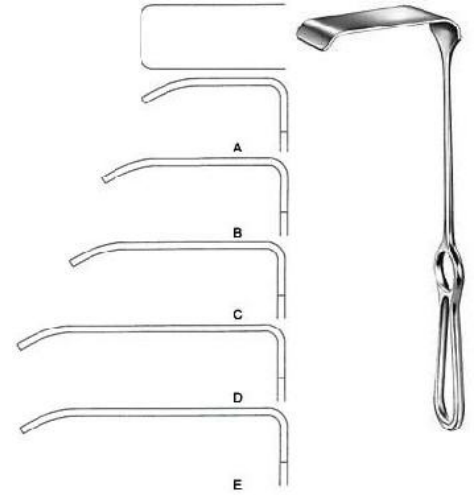

Kocher
AI-5-946-18

Retractor
23 cm 43 x 18 mm, 23 cm 53 x 20 mm, 23 cm
63 x 25 mm, 23 cm 77 x 30 mm, 23 cm 78 x
40 mm,

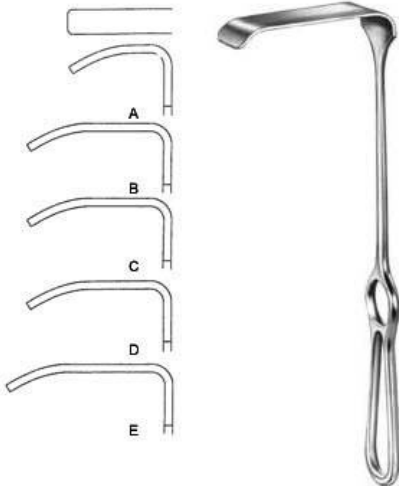

Kocher-Langenbeck
AI-5-947-01

Retractor
21.5 cm 25 x 6 mm, 21.5 cm 35 x 8 mm, 21.5
cm 35 x 11 mm, 21.5 cm 35 x 15 mm, 21.5 cm
40 x 11 mm, 21.5 cm 55 x 11 mm, 21.5 cm 70
x 14 mm, 21.5 cm 80 x 12 mm,

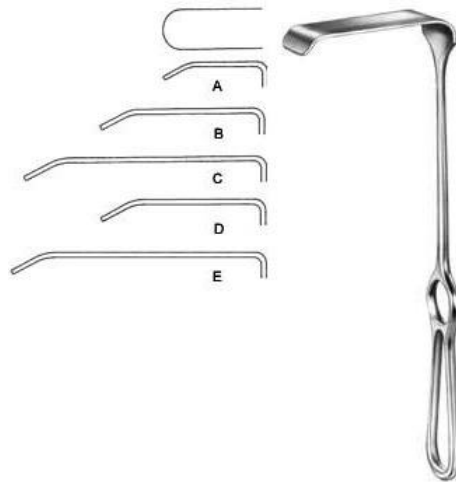

Kocher-Langenbeck
AI-5-948-01

Retractor
21.5 cm 25 x 10 mm, 21.5 cm 40 x 13
mm, 21.5 cm 60 x 13 mm, 21.5 cm 40 x 18
mm, 21.5 cm 60 x 18 mm, 21.5 cm 85 x 18
mm, 21.5 cm 60 x 25 mm, 21.5 cm 85 x 25
mm,

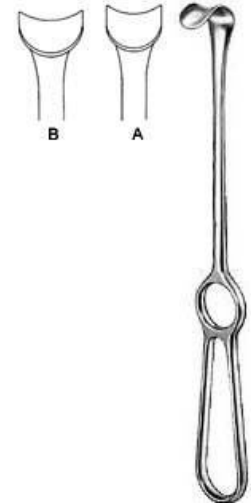

Kocher
AI-5-949-01

Retractor
21.5 cm 22 x 12 mm, 21.5 cm 24 x 14 mm,

Retractors

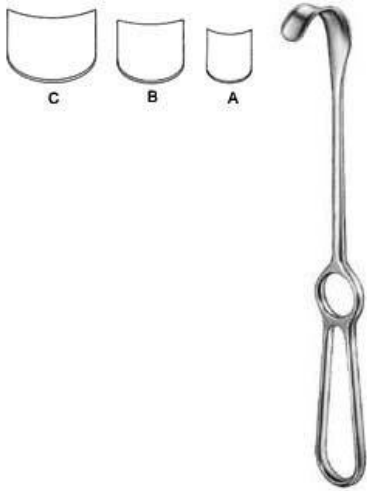

Kocher
AI-5-950-01

Retractor

22 cm 42 x 10 mm, 22 cm 42 x 15 mm, 22 cm 43 x 20 mm,

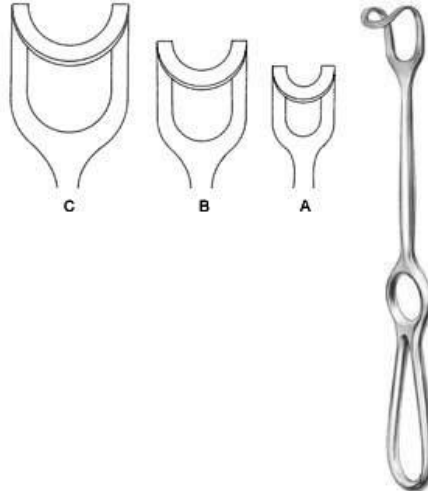

Middeldorpf

AI-5-951-01

Retractor

21.5 cm 18 x 17 mm, 23 cm 25 x 22 mm, 24.5 cm 30 x 31 mm,

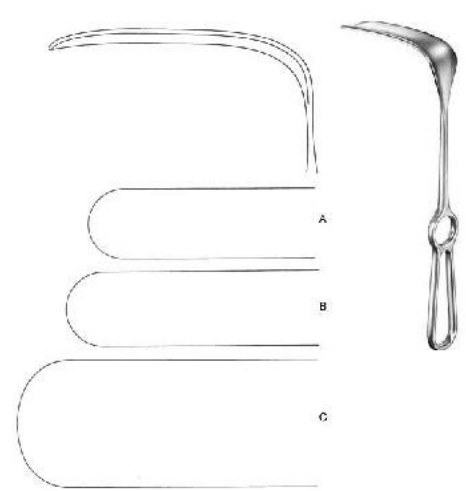

Doyen-Stillé

AI-5-952-01

Retractor

26 cm 97 x 29 mm, 26 cm 101 x 31 mm, 26 cm 127 x 52 mm,

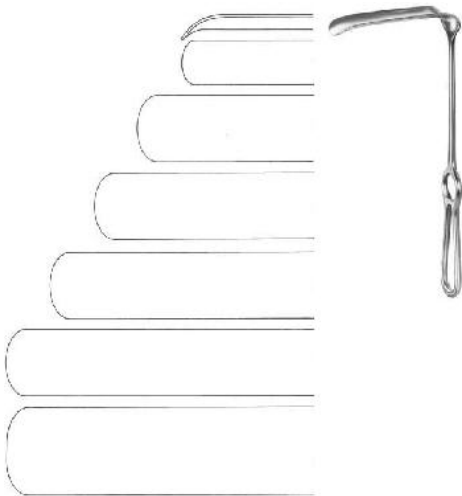

Hosel

AI-5-953-01

Retractor

26 cm 63 x 21 mm, 26 cm 83 x 30 mm, 26 cm 103 x 30 mm, 26 cm 120 x 30 mm, 26 cm 140 x 30 mm, 26 cm 140 x 40 mm,

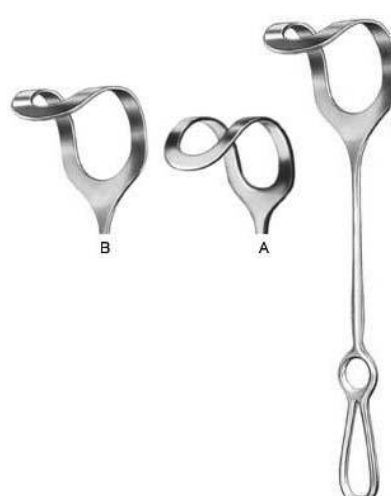

Middeldorpf

AI-5-954-01

Retractor

27 cm 48 x 45 mm, 27 cm 52 x 50 mm, 27 cm 60 x 70 mm,

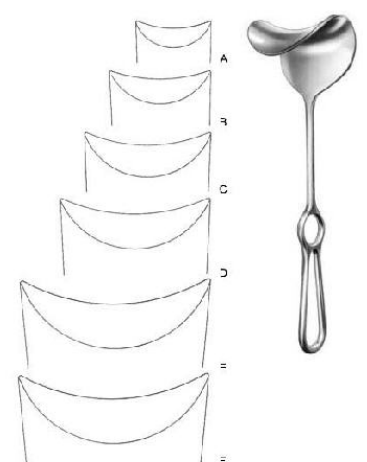

Fritsch

AI-5-955-00

Retractor

23.5 cm 37 x 31 mm, 24 cm 38 x 40 mm, 25 cm 43 x 51 mm, 25 cm 49 x 61 mm, 25.5 cm 48 x 75 mm, 25.5 cm 65 x 85 mm,

Retractors



Doyen
AI-5-956-25
Retractor
24 cm 48 x 88 mm,



Kocher
AI-5-957-22
Retractor
24 cm 73 x 25 mm,



Kocher
AI-5-958-01
Retractor
25 cm 80 x 45 mm, 25 cm 80 x 55 mm, 25 cm 80 x 65 mm,



Martin
AI-5-959-25
Retractor
26 cm 110 x 27 mm,

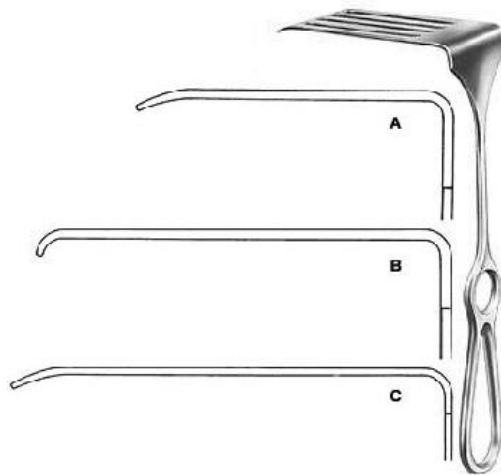

Coryllos
AI-5-960-01
Retractor
24 cm 85 x 22 mm, 24 cm 108 x 43 mm, 24 cm 119 x 65 mm,



Davidson
AI-5-961-01
Retractor
19 cm 80 x 54 mm, 18.5 cm 80 x 95 mm,

Retractors

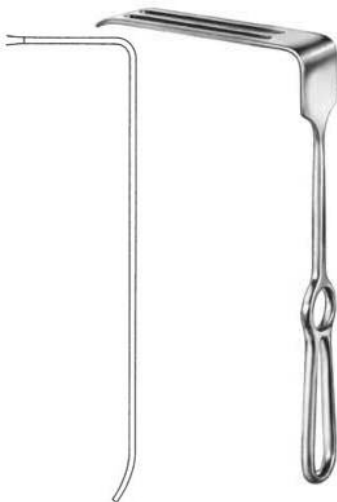

Sauerbruch

AI-5-962-25

Retractor

25.5 cm 127 x 38 mm,

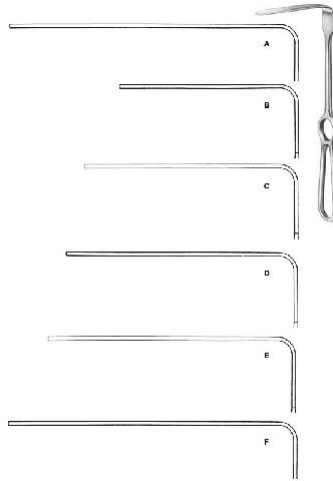

Brunner

AI-5-963-08

Retractor

25.5 cm 84 x 20 mm, 25.5 cm 104 x 25 mm, 25.5 cm 124 x 30 mm, 25.5 cm 130 x 30 mm, 25.5 cm 144 x 30 mm, 25.5 cm 160 x 30 mm, 25.5 cm 164 x 30 mm,

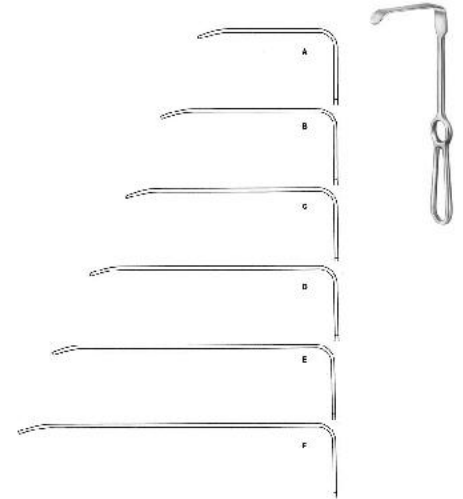

Brunner

AI-5-964-08

Retractor

25.5 cm 82 x 20 mm, 25.5 cm 102 x 20 mm, 25.5 cm 122 x 25 mm, 25.5 cm 140 x 25 mm, 25.5 cm 162 x 30 mm, 25.5 cm 182 x 30 mm,

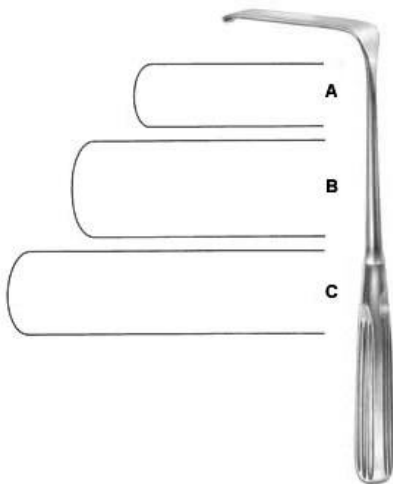

Sauerbruch

AI-5-965-01

Retractor

22.5 cm 50 x 15mm, 22.5 cm 63 x 23mm, 22.5 cm 80 x 20mm,



Deaver

AI-5-966-01

Retractor

18 cm 19mm,

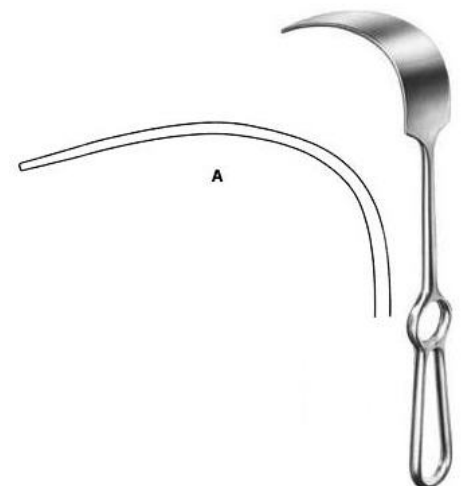

Mikulicz

AI-5-968-01

Retractor

25 cm 90 x 35mm, 25 cm 125 x 50mm, 25 cm 160 x 50mm,

Retractors



Mikulicz
AI-5-969-26
Retractor
26 cm 90 x 55mm,

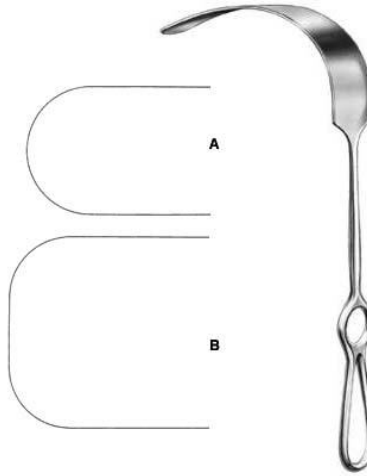

Kelly
AI-5-970-01
Retractor
27.5 cm 205 x 38mm, 27.5 cm 205 x 57mm,



Farabeuf
AI-5-971-00
Retractor
15 cm Fig. 1 = 23 x 16, 15 cm Fig. 1 = 26 x 16, 15 cm Fig. 2 = 27 x 16, 15 cm Fig. 2 = 30 x 16,

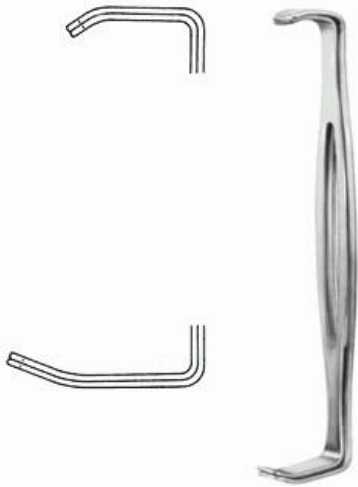

Parker-Langenbeck
AI-5-972-00
Retractor
21.5 cm Fig. 1 = 21x15mm, 21.5 cm Fig. 1 = 40x15mm, 21.5 cm Fig. 2 = 25x15mm, 21.5 cm Fig. 2 = 45x15mm,



Alm
AI-5-973-07
Wound Spreaders, self-retaining
7 cm,



Alm
AI-5-974-07
Wound Spreaders, self-retaining
7 cm,

Retractors



Gosset

AI-5-975-22

Abdominal Retractor
18.5 cm,



Balfour-Baby

AI-5-976-00

Abdominal Retractor spreading 90mm, 1
central blade 24 x 20mm
12.5 cm,



Balfour

AI-5-977-00

Abdominal Retractor spreading 180mm,
lateral blades 70 x 35mm, 1 central blade
20 cm,



Deaver

AI-5-967-04

Retractor

31.5 cm 25mm, 31.5 cm 38mm, 31.5 cm
50mm, 31.5 cm 100mm,



AI-5-1001-11

Probe

11.5 cm, 13 cm, 14.5 cm, 16 cm, 18 cm, 20 cm, 25 cm, 30 cm,



AI-5-1002-11

Probe

11.5 cm, 13 cm, 14.5 cm, 16 cm, 18 cm, 20 cm, 25 cm, 30 cm,

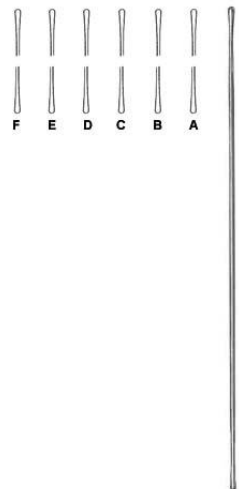

AI-5-1003-13

Probe

13 cm, 14.5 cm, 16 cm, 18 cm, 20 cm, 25 cm,



AI-5-1004-13

Probe with eye

13 cm, 14.5 cm, 16 cm,

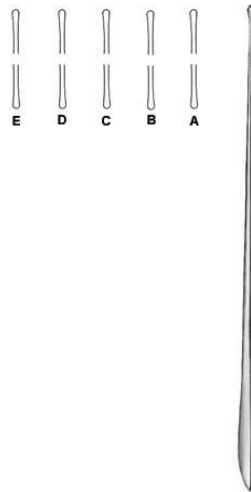

AI-5-1006-13

Myrtle Leaf Probe

13 cm, 14.5 cm, 16 cm, 18 cm, 20 cm,



AI-5-1007-13

Grooved Director

13 cm, 14 cm, 16 cm,



AI-5-1008-13
Grooved Director
13 cm, 14.5 cm, 16 cm,



Doyen
AI-5-1009-14
Grooved Director
14.5 cm,



Nelaton
AI-5-1010-16
Grooved Director
16 cm,

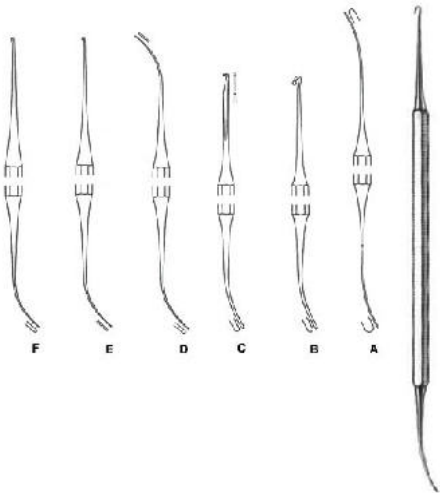

Varady
AI-5-1011-01
Phlebodissector
18 cm, 17.5 cm,

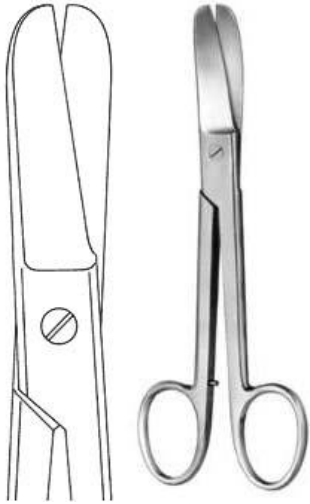

Lorenz

AI-6-101-23

Bandage Scissors heavy pattern
23 cm,



Lister

AI-6-102-14

Bandage Scissors
14.5 cm, 18.5 cm, 20 cm,



Bergmann

AI-6-103-23

Plaster Shears
23.5 cm,



Esmarch

AI-6-104-20

Plaster Shears heavy pattern, short blades
20 cm,



AI-6-105-15

Bandage Scissors black plastic ring with
autodavable
16 cm, 19 cm,



AI-6-106-18

Bandage Scissors black plastic rings
19 cm, 16 cm,

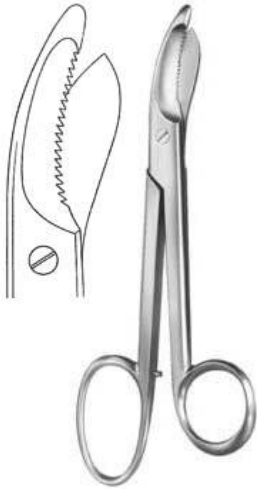

Bruns
AI-6-107-24
Plaster Scissors
24 cm,

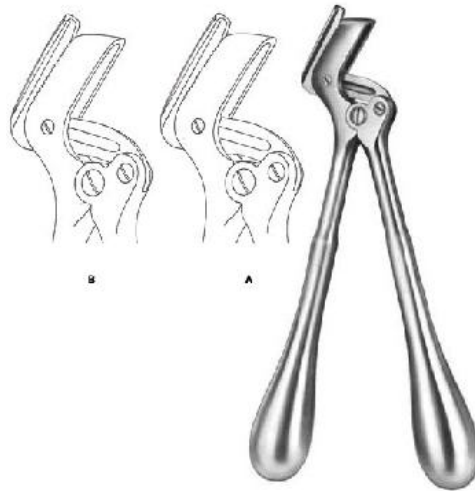

Stille-Martin
AI-6-108-23
Plaster Shears
23 cm, 27 cm, 38 cm,

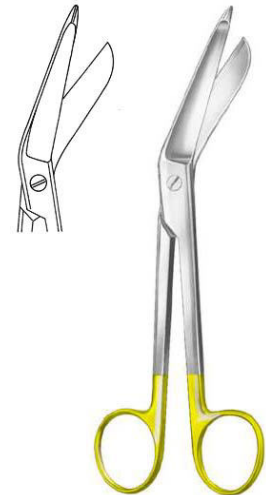

Lister
AI-6-109-18
Bandage Scissors
18 cm,

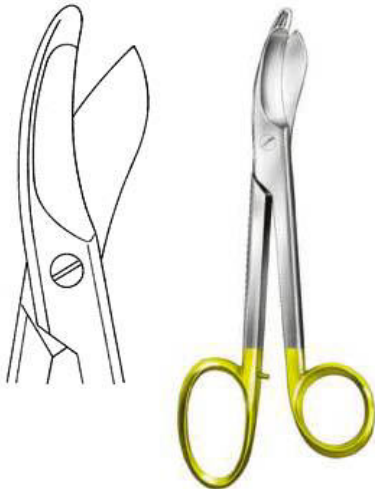

Bruns
AI-6-110-24
Plaster Scissors
24 cm,



Hopkins
AI-6-111-20
Plaster Knife with wooden handle
20 cm,



Reiner
AI-6-112-18
Plaster Knife
18 cm,



Reiner
AI-6-113-18
Plaster Knife
18 cm,



Martin
AI-6-114-21
Plaster Knife with wooden handle
21 cm,



Engel
AI-6-115-14
Plaster Saw
15.5 cm,

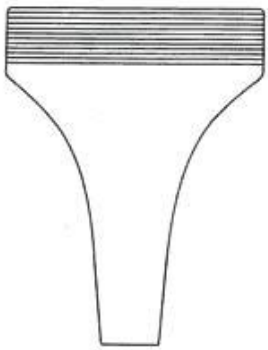

Hennig
AI-6-116-28
Plaster Spreader
28 cm,

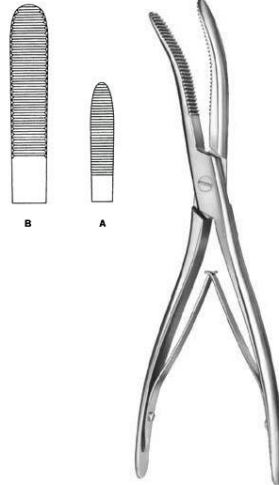

Wolff
AI-6-117-18
Plaster Breaker
18 cm, 26.5 cm,



Gigli
AI-8-101-01
Wire Saw Handle



De Martel
AI-8-102-33
Wire Saw Guide
33 cm,



Crutchfield
AI-8-103-01
Skull Traction Tong small pattern



AI-8-104-01
Skull Traction Tong large pattern
22.5 cm,



Dahlgren
AI-8-105-20
Cranial Rongeur
20 cm,



Olivecrona-Toennis
AI-8-106-14
Clip Applying Forceps



McKenzie
AI-8-107-19
Clip Applying Forceps
18.5 cm,



Olivecrona
AI-8-108-18
Dura Dissector
18 cm,



Olivecrona
AI-8-109-19
Dura Dissector
20 cm,



Milligan
AI-8-110-21
Dura Dissector
21.5 cm,



Davis
AI-8-111-21
Dura Dissector sharp
21.5 cm,



AI-8-112-22
Dura Dissector
22 cm,



Davis
AI-8-113-24
Dura Dissector
24.5 cm,



Love
AI-8-114-19
Nerve Root Retractor
21.5 cm, 18 cm, 11 cm,



Olivecrona
AI-8-115-18
Brain Spatula
18 cm,



Scoville
AI-8-116-23
Nerve Root Retractor 8mm
23.5 cm,



Holsher
AI-8-117-24
Nerve Root Retractor 8mm
23.5 cm,

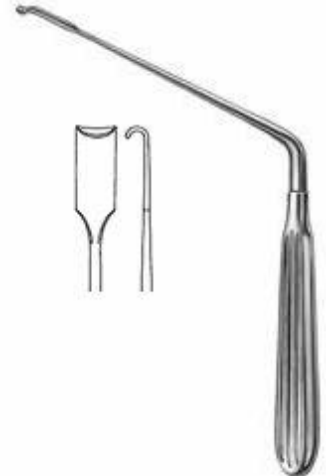

Scoville
AI-8-118-19
Nerve Root Retractor 7mm
16.5 cm,



Groningen
AI-8-119-26
Nerve Hook
26.5 cm,



Groningen
AI-8-120-26
Nerve Hook
26.5 cm,



Cushing
AI-8-121-19
Nerve Hook blunt
19 cm,28 cm,

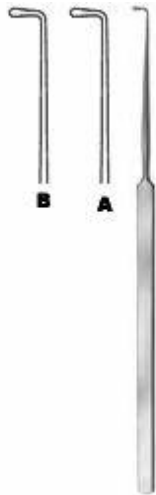

Cushing
AI-8-122-19
Nerve Hook
19.5 cm,28 cm,



Smithwick
AI-8-123-17
Nerve Hook
17 cm,21 cm,



Halle
AI-8-125-20
Dura Knife
20 cm,



Adson
AI-8-126-20
Dura Hook
20 cm,



Graham
AI-8-127-16
Dura Hook blunt
16.5 cm,



Sachs
AI-8-128-18
Dura Hook sharp
18 cm,



Toennis
AI-8-129-15
Dura Hook sharp
14.5 cm,



Frazier
AI-8-130-13
Dura Hook sharp
13 cm, 18 cm,



Krayenbuhl
AI-8-131-01
Nerve and Vessel Hooklet
18.5 cm Fig. 1, 18.5 cm Fig. 2,



Cloward
AI-8-132-16
Lamina Spreader
16 cm,

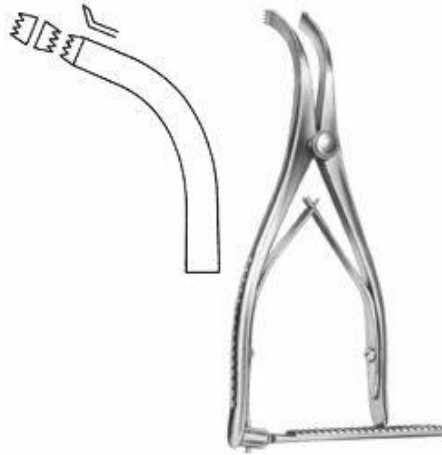

Inge
AI-8-133-17
Lamina Spreader
16 cm,

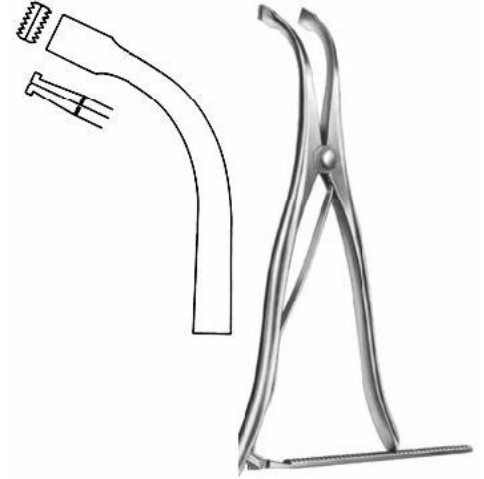

Inge
AI-8-134-27
Lamina Spreader
25.5 cm,

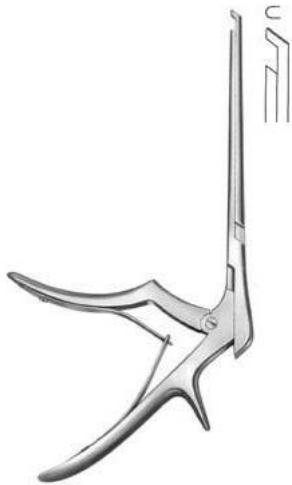

Ferris-Smith Kerrison
AI-8-135-03
Laminectomy Punch 3mm downwards cutting
40 degree shaft length 180 mm

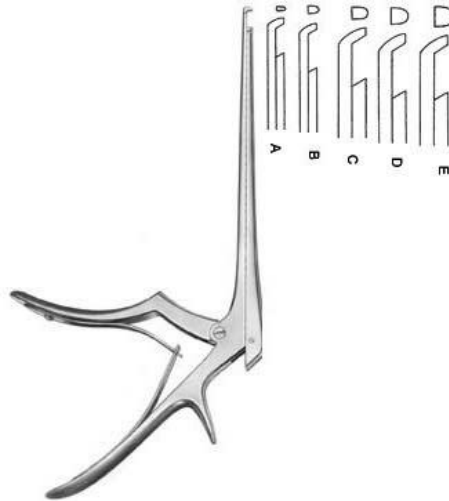

Ferris-Smith Kerrison
AI-8-138-01
Laminectomy Punch upwards cutting shaft
length 180 mm
1 mm, 2 mm, 3 mm, 4 mm, 5 mm, 6 mm,

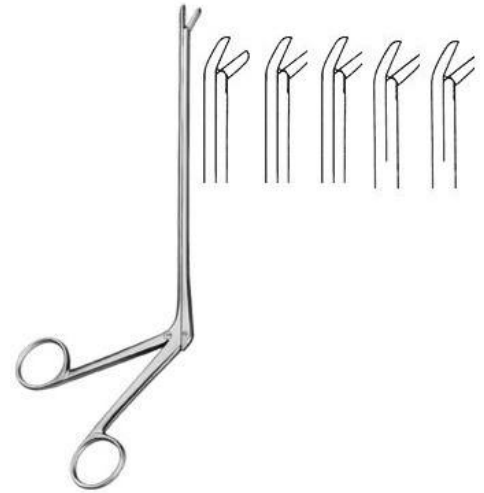

Cushing
AI-8-139-01
Laminectomy Rongeur jaw 2 x 10 to 4 x 10
mm straight shaft length 180 mm

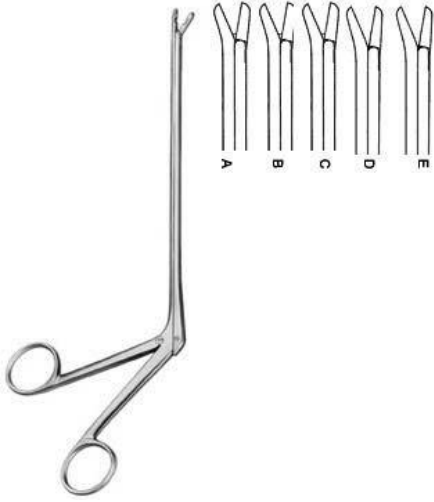

Cushing
AI-8-140-01

Laminectomy Rongeur jaw 2 x 10 to 4 x 10 mm upwards 45 degree shaft length 120 mm

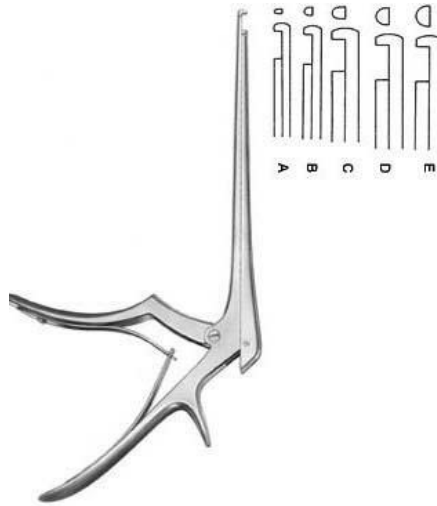

Ferris-Smith Kerrison
AI-8-137-01

Laminectomy Punch
1 mm, 2 mm, 3 mm, 4 mm, 5 mm, 6 mm,

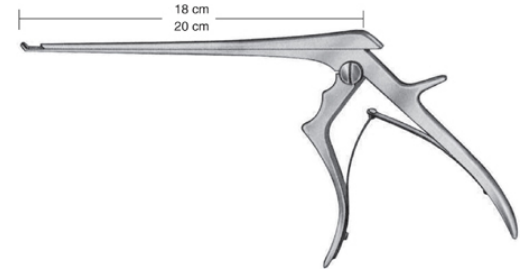

FERRIS-SMITH-KERRISON
AI-9-137-01
with thin footplate

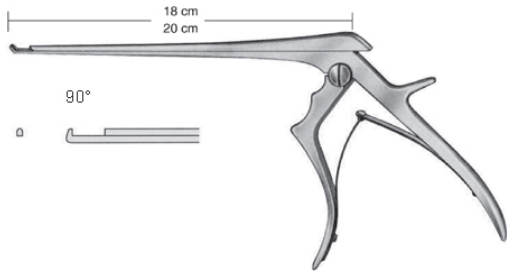

FERRIS-SMITH-KERRISON
AI-9-137-02

With thin footplate
18 cm , 20 cm , 1mm , 2 mm , 3 mm , 4 mm , 5 mm,

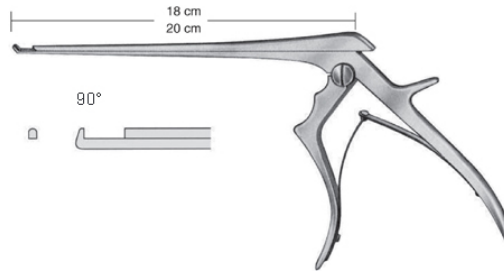

FERRIS-SMITH-KERRISON
AI-9-137-03

With thin footplate
18 cm , 20 cm , 1mm , 2 mm, 3 mm , 4 mm , 5 mm,

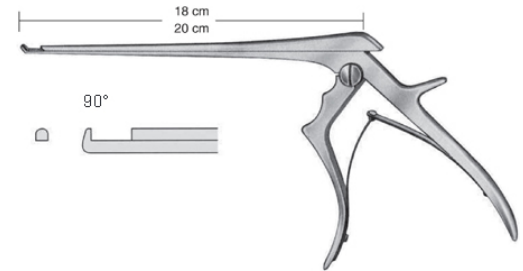

FERRIS-SMITH-KERRISON
AI-9-137-04

With thin footplate
18 cm , 20 cm , 1mm , 2 mm, 3 mm , 4 mm , 5 mm,

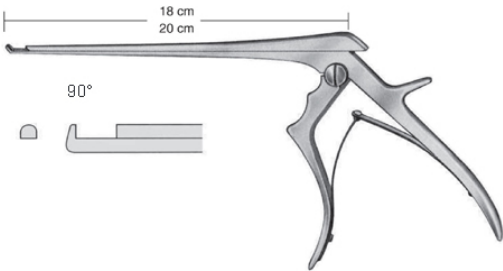

FERRIS-SMITH-KERRISON

AI-9-137-05

With thin footplate

18 cm , 20 cm , 1 mm ,2 mm,3 mm ,4 mm ,5 mm,

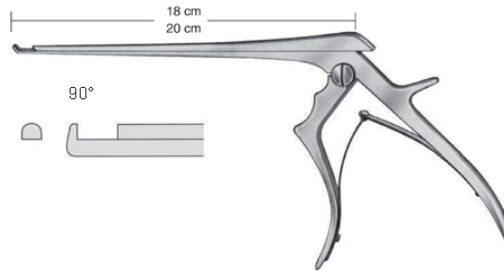

FERRIS-SMITH-KERRISON

AI-9-137-06

With thin footplate

18 cm , 20 cm , 1 mm ,2 mm,3 mm ,4 mm ,5 mm,

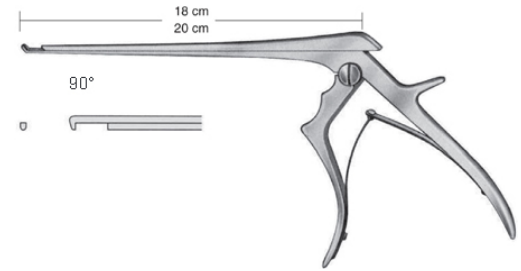

FERRIS-SMITH-KERRISON

AI-9-137-07

with thin footplate

18 cm , 20 cm , 1 mm,2 mm,3 mm,4 mm,5 mm,

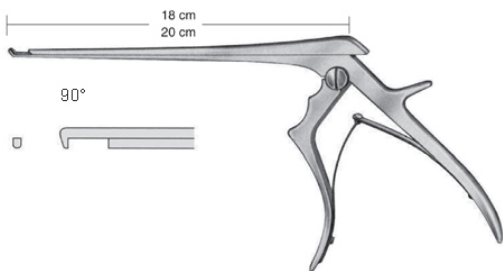

FERRIS-SMITH-KERRISON

AI-9-137-08

with thin footplate

18 cm , 20 cm , 1 mm,2 mm,3 mm,4 mm,5 mm,

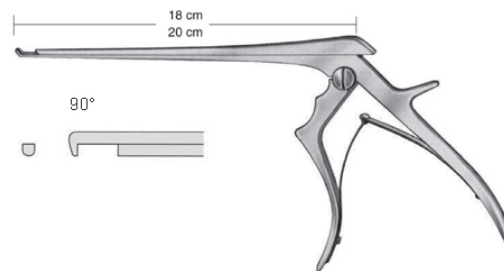

FERRIS-SMITH-KERRISON

AI-9-137-09

with thin footplate

18 cm , 20 cm , 1 mm,2 mm,3 mm,4 mm,5 mm,

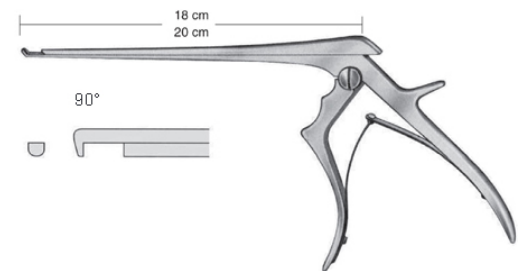

FERRIS-SMITH-KERRISON

AI-9-137-10

with thin footplate

18 cm , 20 cm , 1 mm,2 mm,3 mm,4 mm,5 mm,

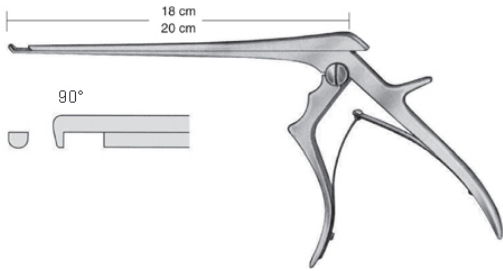

FERRIS-SMITH-KERRISON

AI-9-137-11

with thin footplate

18 cm , 20 cm , 1 mm,2 mm,3 mm,4 mm,5 mm,

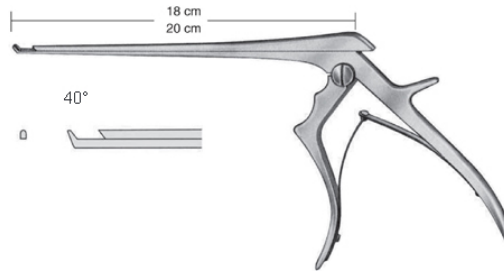

FERRIS-SMITH-KERRISON

AI-9-137-12

with thin footplate

1 mm,2 mm,3 mm,4 mm,5 mm,

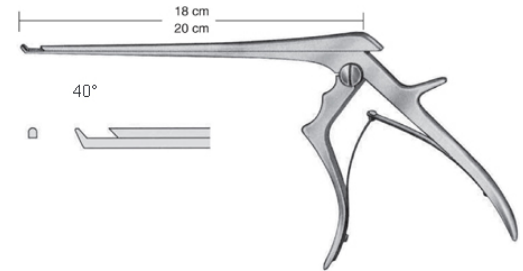

FERRIS-SMITH-KERRISON

AI-9-137-13

with thin footplate

1 mm,2 mm,3 mm,4 mm,5 mm,

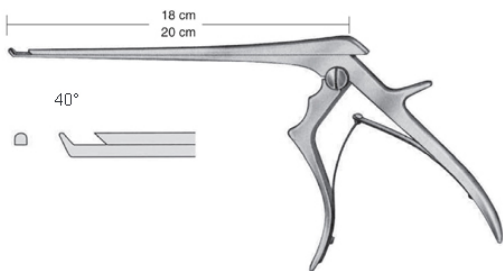

FERRIS-SMITH-KERRISON

AI-9-137-14

with thin footplate

1 mm,2 mm,3 mm,4 mm,5 mm,

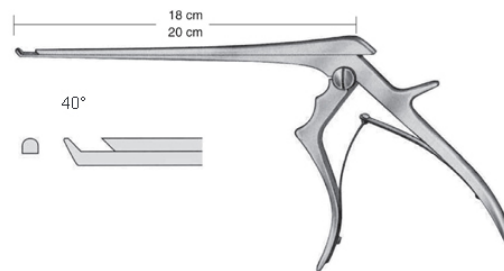

FERRIS-SMITH-KERRISON

AI-9-137-15

with thin footplate

1 mm,2 mm,3 mm,4 mm,5 mm,

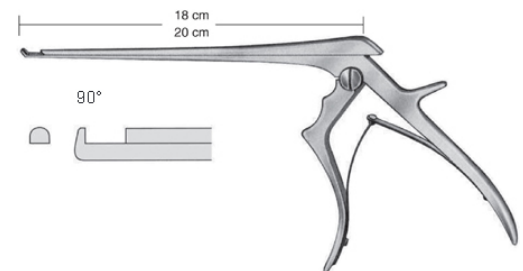

FERRIS-SMITH-KERRISON

AI-9-137-16

with thin footplate

1 mm,2 mm,3 mm,4 mm,5 mm,

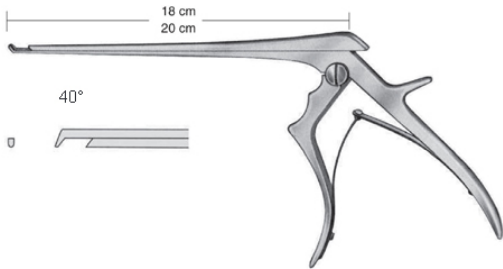

FERRIS-SMITH-KERRISON
AI-9-137-17
with thin footplate
1 mm,2 mm,3 mm,4 mm,5 mm,

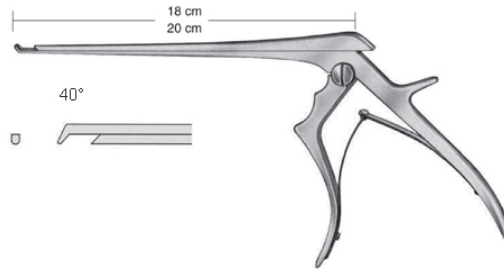

FERRIS-SMITH-KERRISON
AI-9-137-18
with thin footplate
1 mm,2 mm,3 mm,4 mm,5 mm,

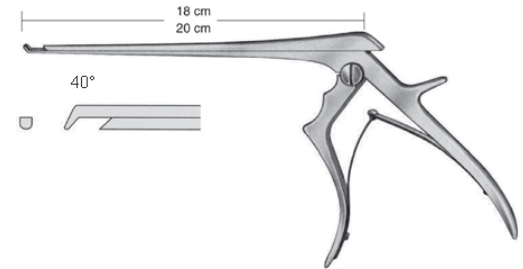

FERRIS-SMITH-KERRISON
AI-9-137-19
with thin footplate
1 mm,2 mm,3 mm,4 mm,5 mm,

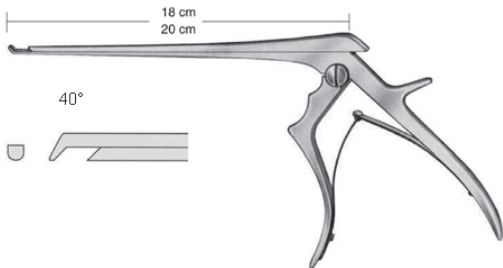

FERRIS-SMITH-KERRISON
AI-9-137-20
with thin footplate
1 mm,2 mm,3 mm,4 mm,5 mm,

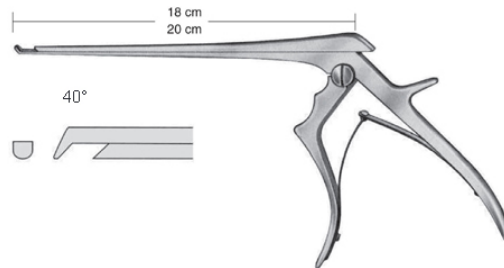

FERRIS-SMITH-KERRISON
AI-9-137-21
with thin footplate
1 mm,2 mm,3 mm,4 mm,5 mm,

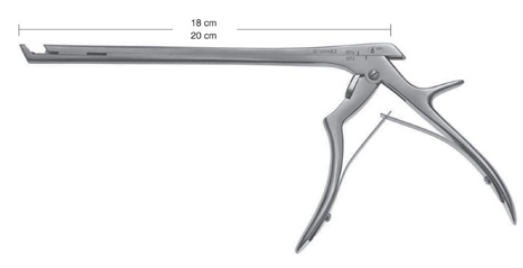

AI-9-137-22
18 cm,20 cm ,

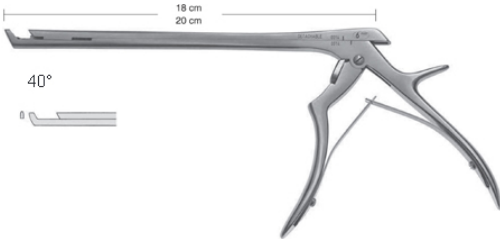

AI-9-137-23

18 cm , 20 cm , 1mm,2 mm,3 mm,4 mm,5 mm,6 mm,

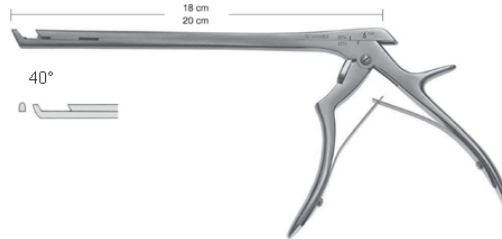

AI-9-137-24

18 cm , 20 cm , 1mm,2 mm,3 mm,4 mm,5 mm,6 mm,

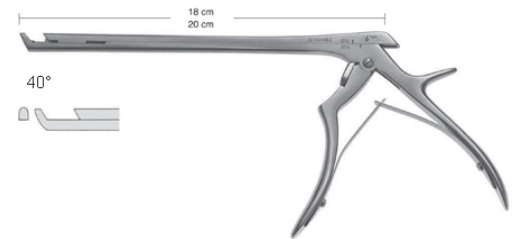

AI-9-137-25

18 cm , 20 cm , 1mm,2 mm,3 mm,4 mm,5 mm,6 mm,

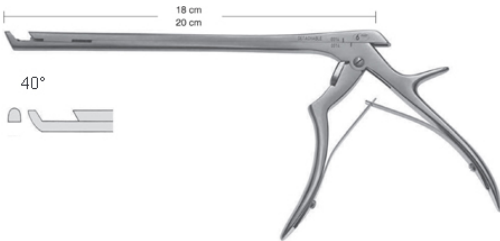

AI-9-137-26

18 cm , 20 cm , 1mm,2 mm,3 mm,4 mm,5 mm,6 mm,

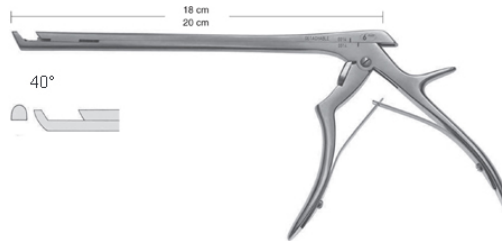

AI-9-137-27

18 cm , 20 cm , 1mm,2 mm,3 mm,4 mm,5 mm,6 mm,

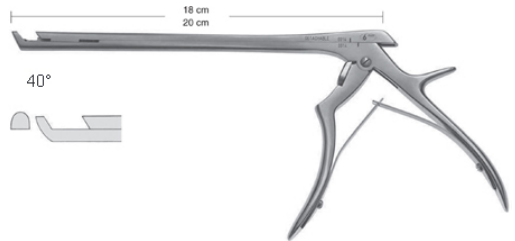

AI-9-137-28

18 cm , 20 cm , 1mm,2 mm,3 mm,4 mm,5 mm,6 mm,

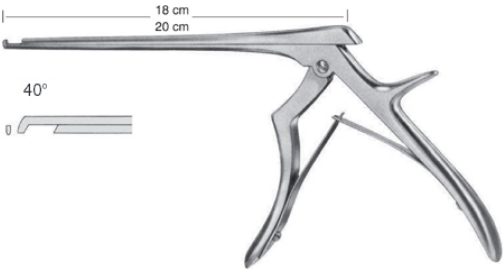

AI-9-137-29

18 cm , 20 cm , 1mm,2 mm,3 mm,4 mm,5 mm,6 mm,

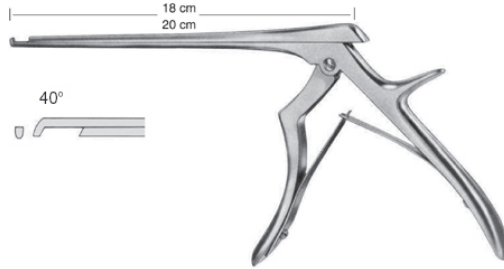

AI-9-137-30

18 cm , 20 cm , 1mm,2 mm,3 mm,4 mm,5 mm,6 mm,

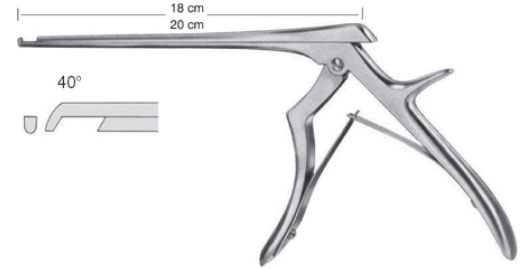

AI-9-137-31

18 cm , 20 cm , 1mm,2 mm,3 mm,4 mm,5 mm,6 mm,

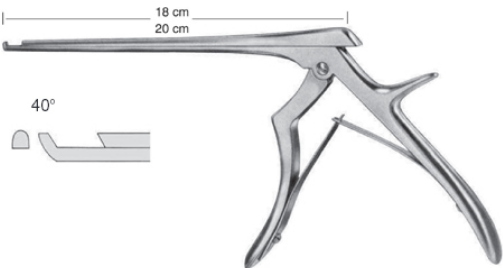

AI-9-137-32

18 cm , 20 cm , 1mm,2 mm,3 mm,4 mm,5 mm,6 mm,

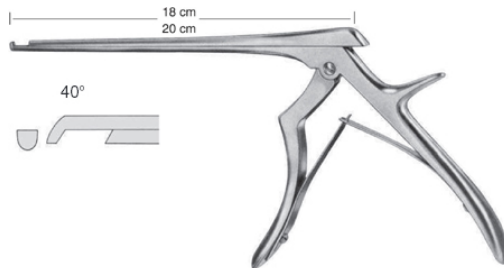

AI-9-137-33

18 cm , 20 cm , 1mm,2 mm,3 mm,4 mm,5 mm,6 mm,

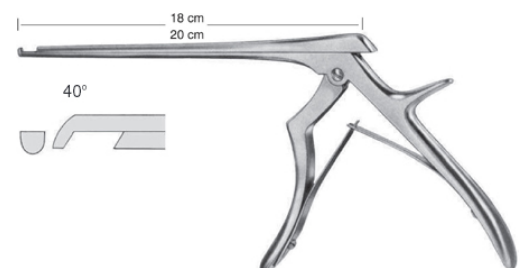

AI-9-137-34

18 cm , 20 cm , 1mm,2 mm,3 mm,4 mm,5 mm,6 mm,



detachable
AI-9-137-35
detachable

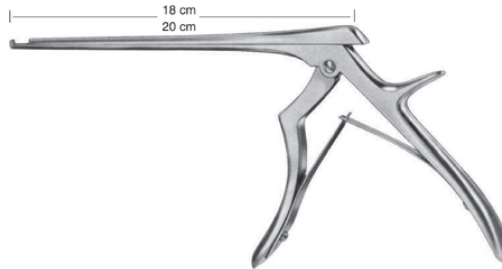

FERRIS-SMITH-KERRISON
AI-9-137-36
FERRIS-SMITH-KERRISON

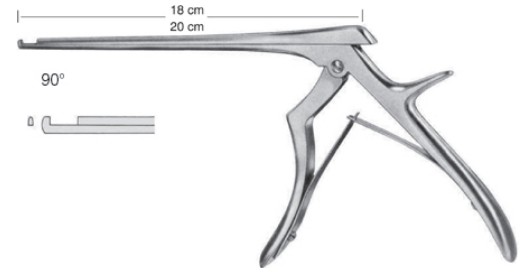

FERRIS-SMITH-KERRISON
AI-9-137-37
FERRIS-SMITH-KERRISON
18 cm , 20 cm ,
1mm,2mm,3mm,4mm,5mm,6mm,

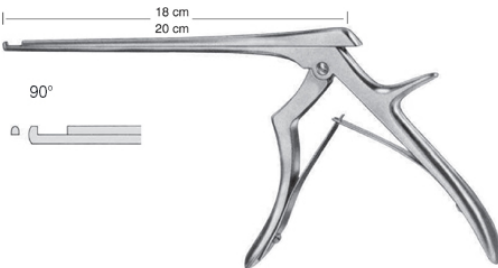

FERRIS-SMITH-KERRISON
AI-9-137-38

FERRIS-SMITH-KERRISON
18 cm , 20 cm , 1mm,18 cm , 20 cm ,
2mm,18 cm , 20 cm , 3mm,18 cm , 20 cm ,
4mm,18 cm , 20 cm , 5mm,18 cm , 20 cm ,
6mm,

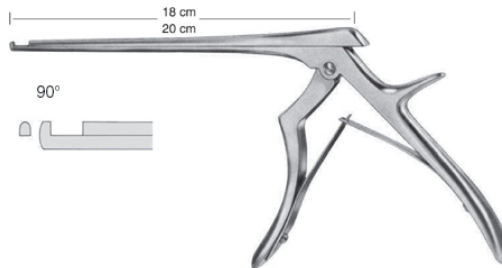

FERRIS-SMITH-KERRISON
AI-9-137-39

FERRIS-SMITH-KERRISON
18 cm , 20 cm , 1mm,18 cm , 20 cm ,
2mm,18 cm , 20 cm , 3mm,18 cm , 20 cm ,
4mm,18 cm , 20 cm , 5mm,18 cm , 20 cm ,
6mm,

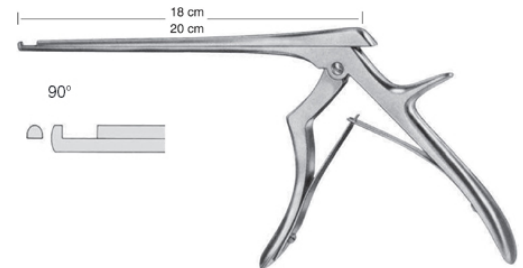

FERRIS-SMITH-KERRISON
AI-9-137-40

FERRIS-SMITH-KERRISON
18 cm , 20 cm , 1mm,18 cm , 20 cm ,
2mm,18 cm , 20 cm , 3mm,18 cm , 20 cm ,
4mm,18 cm , 20 cm , 5mm,18 cm , 20 cm ,
6mm,

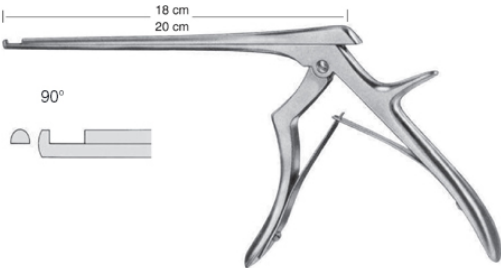

FERRIS-SMITH-KERRISON
AI-9-137-41

FERRIS-SMITH-KERRISON
18 cm , 20 cm , 1mm,18 cm , 20 cm ,
2mm,18 cm , 20 cm , 3mm,18 cm , 20 cm ,
4mm,18 cm , 20 cm , 5mm,18 cm , 20 cm ,
6mm,

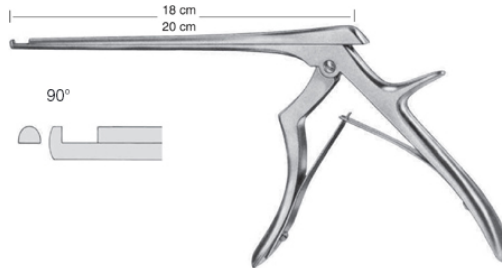

FERRIS-SMITH-KERRISON
AI-9-137-42

FERRIS-SMITH-KERRISON
18 cm , 20 cm , 1mm,18 cm , 20 cm ,
2mm,18 cm , 20 cm , 3mm,18 cm , 20 cm ,
4mm,18 cm , 20 cm , 5mm,18 cm , 20 cm ,
6mm,

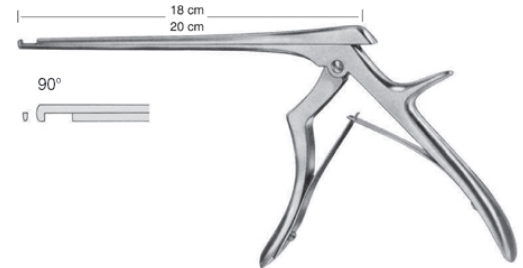

FERRIS-SMITH-KERRISON
AI-9-137-43

FERRIS-SMITH-KERRISON
18 cm , 20 cm , 1mm,18 cm , 20 cm ,
2mm,18 cm , 20 cm , 3mm,18 cm , 20 cm ,
4mm,18 cm , 20 cm , 5mm,18 cm , 20 cm ,
6mm,

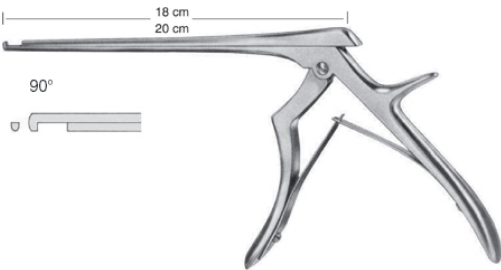

FERRIS-SMITH-KERRISON
AI-9-137-44

FERRIS-SMITH-KERRISON
18 cm , 20 cm , 1mm,18 cm , 20 cm ,
2mm,18 cm , 20 cm , 3mm,18 cm , 20 cm ,
4mm,18 cm , 20 cm , 5mm,18 cm , 20 cm ,
6mm,

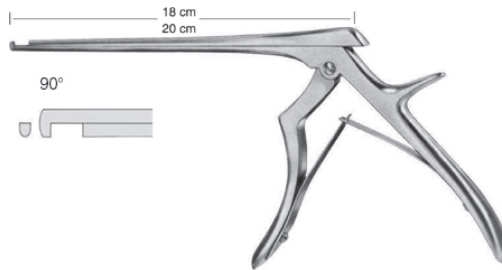

FERRIS-SMITH-KERRISON
AI-9-137-45

FERRIS-SMITH-KERRISON
18 cm , 20 cm , 1mm,18 cm , 20 cm ,
2mm,18 cm , 20 cm , 3mm,18 cm , 20 cm ,
4mm,18 cm , 20 cm , 5mm,18 cm , 20 cm ,
6mm,

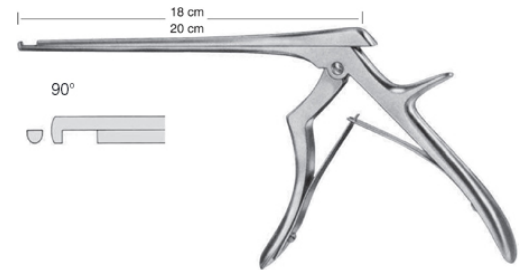

FERRIS-SMITH-KERRISON
AI-9-137-46

FERRIS-SMITH-KERRISON
18 cm , 20 cm , 1mm,18 cm , 20 cm ,
2mm,18 cm , 20 cm , 3mm,18 cm , 20 cm ,
4mm,18 cm , 20 cm , 5mm,18 cm , 20 cm ,
6mm,

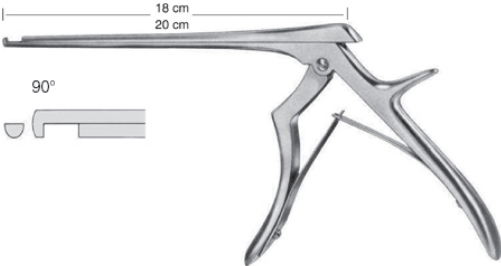

FERRIS-SMITH-KERRISON
AI-9-137-47

FERRIS-SMITH-KERRISON
18 cm , 20 cm , 1mm,18 cm , 20 cm ,
2mm,18 cm , 20 cm , 3mm,18 cm , 20 cm ,
4mm,18 cm , 20 cm , 5mm,18 cm , 20 cm ,
6mm,

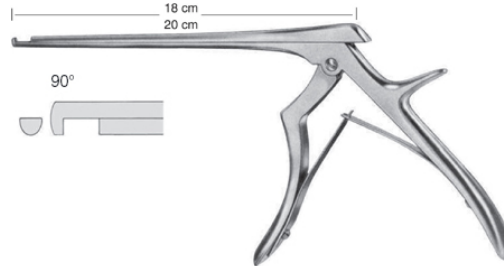

FERRIS-SMITH-KERRISON
AI-9-137-48

FERRIS-SMITH-KERRISON
18 cm , 20 cm , 1mm,18 cm , 20 cm ,
2mm,18 cm , 20 cm , 3mm,18 cm , 20 cm ,
4mm,18 cm , 20 cm , 5mm,18 cm , 20 cm ,
6mm,

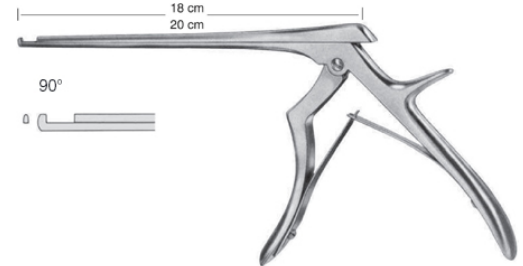

FERRIS-SMITH-KERRISON
AI-9-137-49

FERRIS-SMITH-KERRISON
18 cm , 20 cm , 1mm,18 cm , 20 cm ,
2mm,18 cm , 20 cm , 3mm,18 cm , 20 cm ,
4mm,18 cm , 20 cm , 5mm,18 cm , 20 cm ,
6mm,

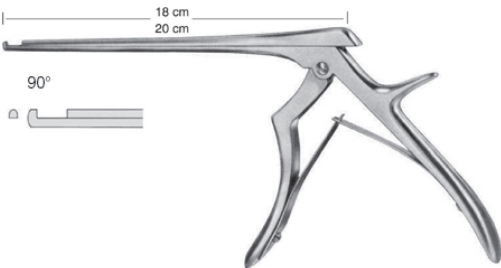

FERRIS-SMITH-KERRISON
AI-9-137-50

FERRIS-SMITH-KERRISON
18 cm , 20 cm , 1mm,18 cm , 20 cm ,
2mm,18 cm , 20 cm , 3mm,18 cm , 20 cm ,
4mm,18 cm , 20 cm , 5mm,18 cm , 20 cm ,
6mm,

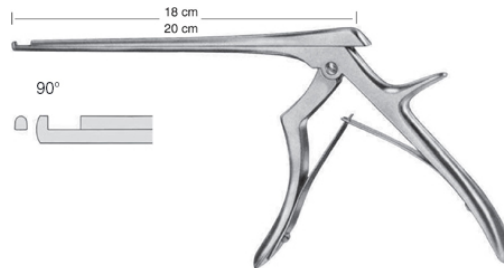

FERRIS-SMITH-KERRISON
AI-9-137-51

FERRIS-SMITH-KERRISON
18 cm , 20 cm , 1mm,18 cm , 20 cm ,
2mm,18 cm , 20 cm , 3mm,18 cm , 20 cm ,
4mm,18 cm , 20 cm , 5mm,18 cm , 20 cm ,
6mm,

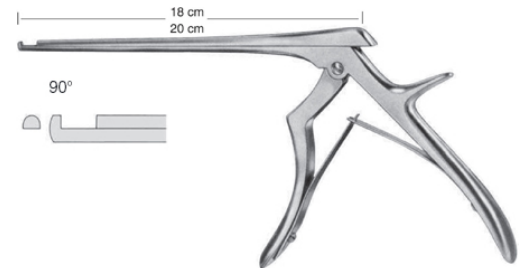

FERRIS-SMITH-KERRISON
AI-9-137-52

FERRIS-SMITH-KERRISON
18 cm , 20 cm , 1mm,18 cm , 20 cm ,
2mm,18 cm , 20 cm , 3mm,18 cm , 20 cm ,
4mm,18 cm , 20 cm , 5mm,18 cm , 20 cm ,
6mm,

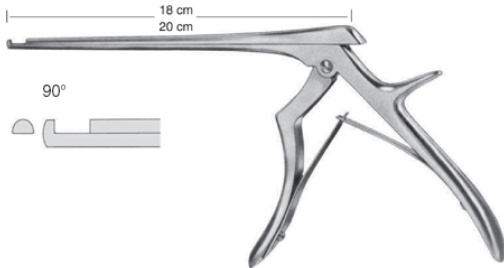

FERRIS-SMITH-KERRISON
AI-9-137-53

FERRIS-SMITH-KERRISON
18 cm , 20 cm , 1mm,18 cm , 20 cm ,
2mm,18 cm , 20 cm , 3mm,18 cm , 20 cm ,
4mm,18 cm , 20 cm , 5mm,18 cm , 20 cm ,
6mm,

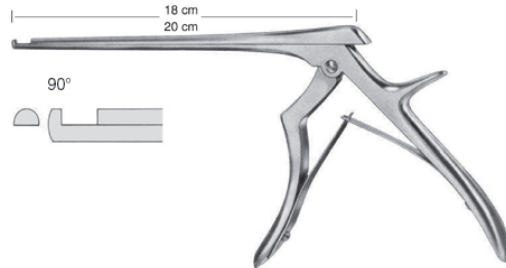

FERRIS-SMITH-KERRISON
AI-9-137-54

FERRIS-SMITH-KERRISON
18 cm , 20 cm , 1mm,18 cm , 20 cm ,
2mm,18 cm , 20 cm , 3mm,18 cm , 20 cm ,
4mm,18 cm , 20 cm , 5mm,18 cm , 20 cm ,
6mm,

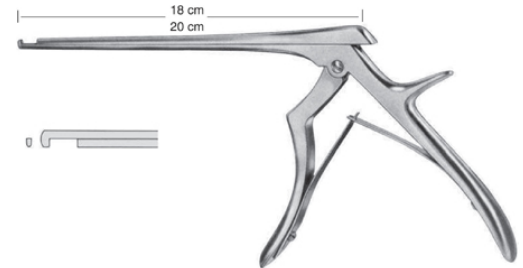

FERRIS-SMITH-KERRISON
AI-9-137-55

FERRIS-SMITH-KERRISON
18 cm , 20 cm , 1mm,18 cm , 20 cm ,
2mm,18 cm , 20 cm , 3mm,18 cm , 20 cm ,
4mm,18 cm , 20 cm , 5mm,18 cm , 20 cm ,
6mm,

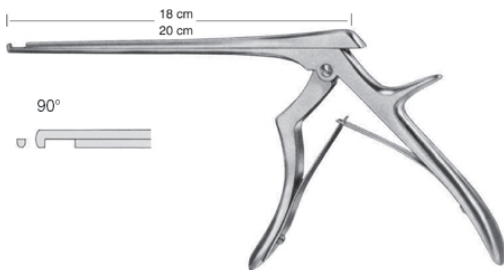

FERRIS-SMITH-KERRISON
AI-9-137-56

FERRIS-SMITH-KERRISON
18 cm , 20 cm , 1mm,18 cm , 20 cm ,
2mm,18 cm , 20 cm , 3mm,18 cm , 20 cm ,
4mm,18 cm , 20 cm , 5mm,18 cm , 20 cm ,
6mm,

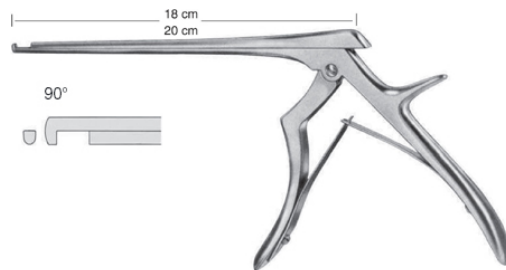

FERRIS-SMITH-KERRISON
AI-9-137-57

FERRIS-SMITH-KERRISON
18 cm , 20 cm , 1mm,18 cm , 20 cm ,
2mm,18 cm , 20 cm , 3mm,18 cm , 20 cm ,
4mm,18 cm , 20 cm , 5mm,18 cm , 20 cm ,
6mm,

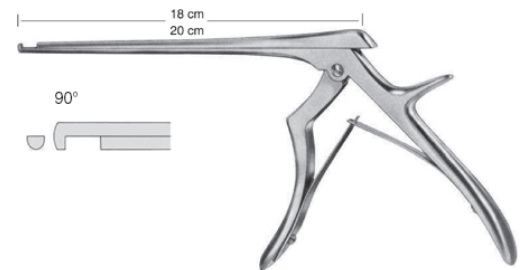

FERRIS-SMITH-KERRISON
AI-9-137-58

FERRIS-SMITH-KERRISON
18 cm , 20 cm , 1mm,18 cm , 20 cm ,
2mm,18 cm , 20 cm , 3mm,18 cm , 20 cm ,
4mm,18 cm , 20 cm , 5mm,18 cm , 20 cm ,
6mm,

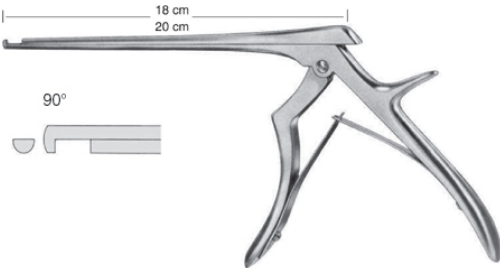

FERRIS-SMITH-KERRISON
AI-9-137-59

FERRIS-SMITH-KERRISON
18 cm , 20 cm , 1mm,18 cm , 20 cm ,
2mm,18 cm , 20 cm , 3mm,18 cm , 20 cm ,
4mm,18 cm , 20 cm , 5mm,18 cm , 20 cm ,
6mm,

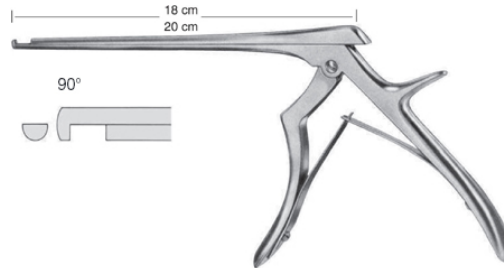

FERRIS-SMITH-KERRISON
AI-9-137-60

FERRIS-SMITH-KERRISON
18 cm , 20 cm , 1mm,18 cm , 20 cm ,
2mm,18 cm , 20 cm , 3mm,18 cm , 20 cm ,
4mm,18 cm , 20 cm , 5mm,18 cm , 20 cm ,
6mm,

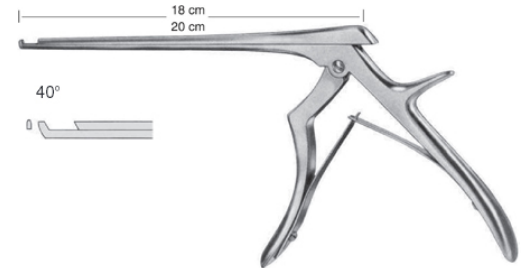

FERRIS-SMITH-KERRISON
AI-9-137-61

FERRIS-SMITH-KERRISON
18 cm , 20 cm , 1mm,18 cm , 20 cm ,
2mm,18 cm , 20 cm , 3mm,18 cm , 20 cm ,
4mm,18 cm , 20 cm , 5mm,18 cm , 20 cm ,
6mm,

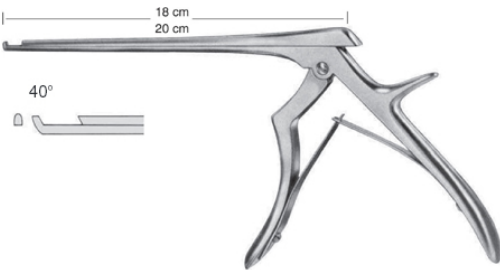

FERRIS-SMITH-KERRISON
AI-9-137-62

FERRIS-SMITH-KERRISON
18 cm , 20 cm , 1mm,18 cm , 20 cm ,
2mm,18 cm , 20 cm , 3mm,18 cm , 20 cm ,
4mm,18 cm , 20 cm , 5mm,18 cm , 20 cm ,
6mm,

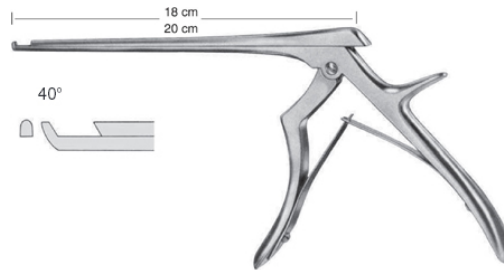

FERRIS-SMITH-KERRISON
AI-9-137-63

FERRIS-SMITH-KERRISON
18 cm , 20 cm , 1mm,18 cm , 20 cm ,
2mm,18 cm , 20 cm , 3mm,18 cm , 20 cm ,
4mm,18 cm , 20 cm , 5mm,18 cm , 20 cm ,
6mm,

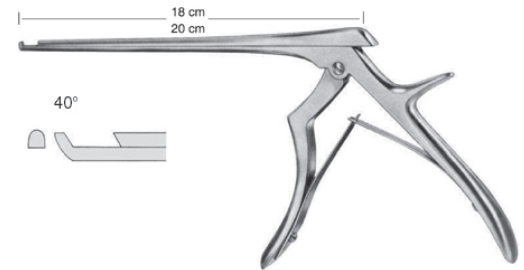

FERRIS-SMITH-KERRISON
AI-9-137-64

FERRIS-SMITH-KERRISON
18 cm , 20 cm , 1mm,18 cm , 20 cm ,
2mm,18 cm , 20 cm , 3mm,18 cm , 20 cm ,
4mm,18 cm , 20 cm , 5mm,18 cm , 20 cm ,
6mm,

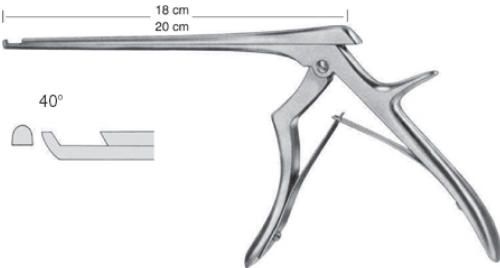

FERRIS-SMITH-KERRISON
AI-9-137-65

FERRIS-SMITH-KERRISON
18 cm , 20 cm , 1mm,18 cm , 20 cm ,
2mm,18 cm , 20 cm , 3mm,18 cm , 20 cm ,
4mm,18 cm , 20 cm , 5mm,18 cm , 20 cm ,
6mm,

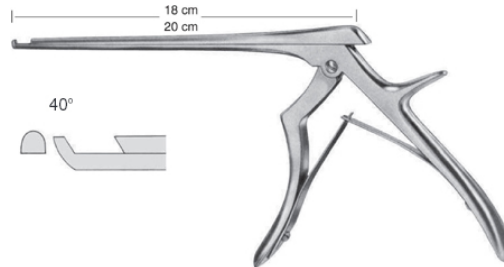

FERRIS-SMITH-KERRISON
AI-9-137-66

FERRIS-SMITH-KERRISON
18 cm , 20 cm , 1mm,18 cm , 20 cm ,
2mm,18 cm , 20 cm , 3mm,18 cm , 20 cm ,
4mm,18 cm , 20 cm , 5mm,18 cm , 20 cm ,
6mm,

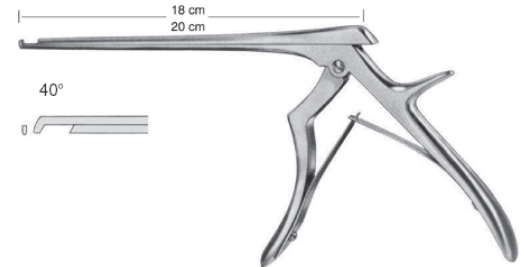

FERRIS-SMITH-KERRISON
AI-9-137-67

FERRIS-SMITH-KERRISON
18 cm , 20 cm , 1mm,18 cm , 20 cm ,
2mm,18 cm , 20 cm , 3mm,18 cm , 20 cm ,
4mm,18 cm , 20 cm , 5mm,18 cm , 20 cm ,
6mm,

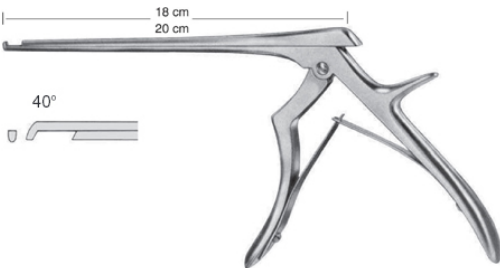

FERRIS-SMITH-KERRISON
AI-9-137-68

FERRIS-SMITH-KERRISON
18 cm , 20 cm , 1mm,18 cm , 20 cm ,
2mm,18 cm , 20 cm , 3mm,18 cm , 20 cm ,
4mm,18 cm , 20 cm , 5mm,18 cm , 20 cm ,
6mm,

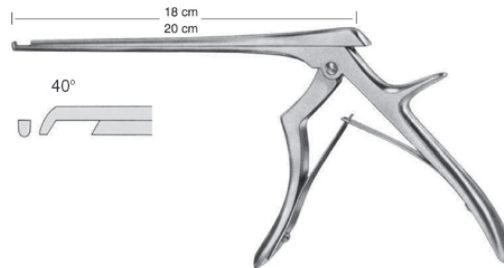

FERRIS-SMITH-KERRISON
AI-9-137-69

FERRIS-SMITH-KERRISON
18 cm , 20 cm , 1mm,18 cm , 20 cm ,
2mm,18 cm , 20 cm , 3mm,18 cm , 20 cm ,
4mm,18 cm , 20 cm , 5mm,18 cm , 20 cm ,
6mm,

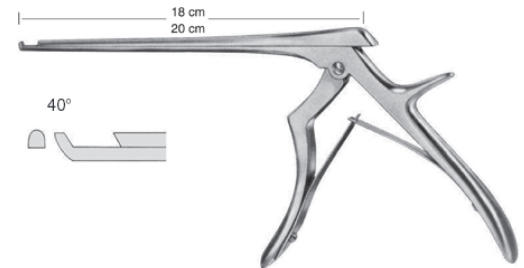

FERRIS-SMITH-KERRISON
AI-9-137-70

FERRIS-SMITH-KERRISON
18 cm , 20 cm , 1mm,18 cm , 20 cm ,
2mm,18 cm , 20 cm , 3mm,18 cm , 20 cm ,
4mm,18 cm , 20 cm , 5mm,18 cm , 20 cm ,
6mm,

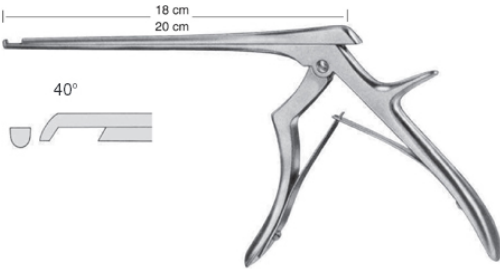

FERRIS-SMITH-KERRISON

AI-9-137-71

FERRIS-SMITH-KERRISON

18 cm , 20 cm , 1mm,18 cm , 20 cm ,
2mm,18 cm , 20 cm , 3mm,18 cm , 20 cm ,
4mm,18 cm , 20 cm , 5mm,18 cm , 20 cm ,
6mm,

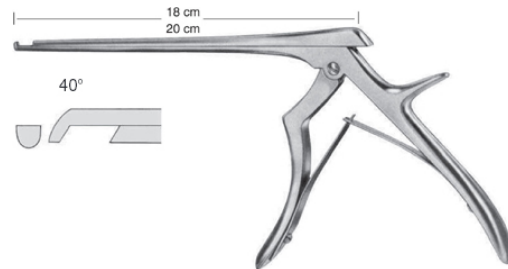

FERRIS-SMITH-KERRISON

AI-9-137-72

FERRIS-SMITH-KERRISON

18 cm , 20 cm , 1mm,18 cm , 20 cm ,
2mm,18 cm , 20 cm , 3mm,18 cm , 20 cm ,
4mm,18 cm , 20 cm , 5mm,18 cm , 20 cm ,
6mm,

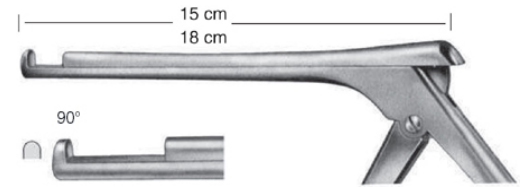

COLCLOUGH

AI-9-137-73

COLCLOUGH

3 mm
5 mm

15 cm,18 cm,

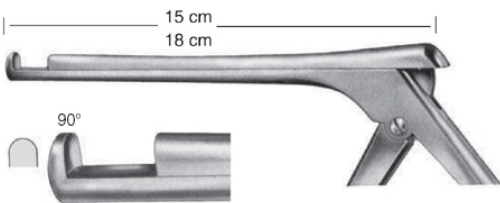

COLCLOUGH

AI-9-137-74

COLCLOUGH

3 mm
5 mm
15 cm,18 cm,

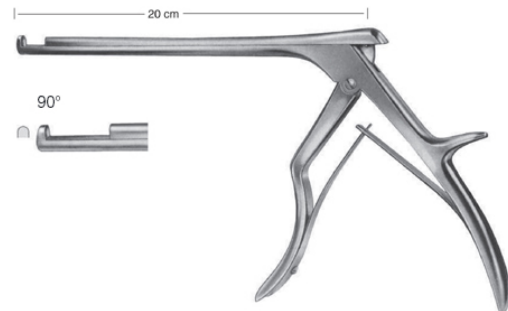

COLCLOUGH

AI-9-137-75

COLCLOUGH

3 mm
5 mm
20 cm,

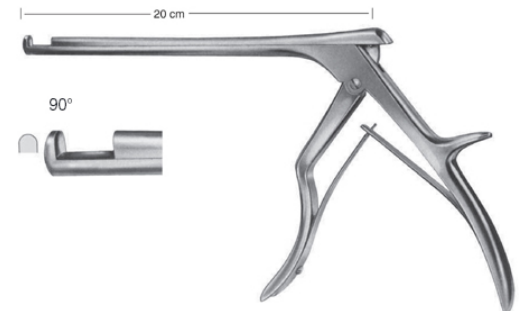

COLCLOUGH

AI-9-137-76

COLCLOUGH

3 mm
5 mm
20 cm,

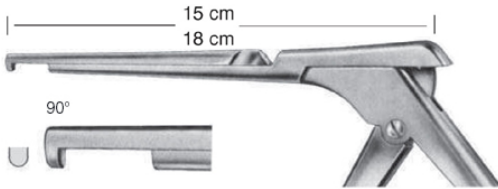

COLCLOUGH
AI-9-137-77
COLCLOUGH
3 mm
5 mm
15 cm, 18 cm,

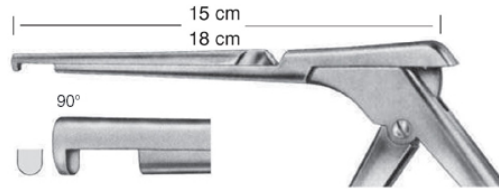

COLCLOUGH
AI-9-137-78
COLCLOUGH
3 mm
5 mm
15 cm, 18 cm,

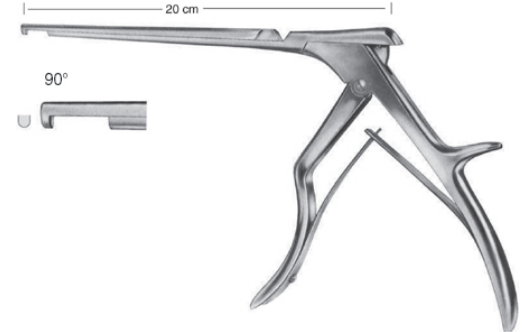

COLCLOUGH
AI-9-137-79
COLCLOUGH
3 mm
5 mm
20 cm,

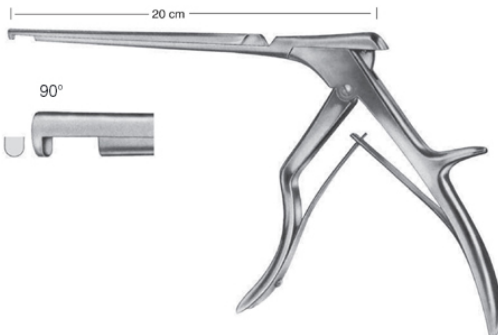

COLCLOUGH
AI-9-137-80
COLCLOUGH
3 mm
5 mm
20 cm,

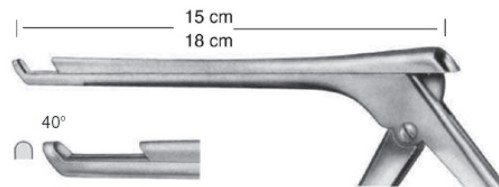

COLCLOUGH
AI-9-137-81
COLCLOUGH
3 mm
5 mm
15 cm, 18 cm,

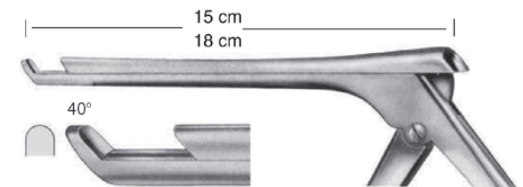

COLCLOUGH
AI-9-137-82
COLCLOUGH
3 mm
5 mm
15 cm, 18 cm,

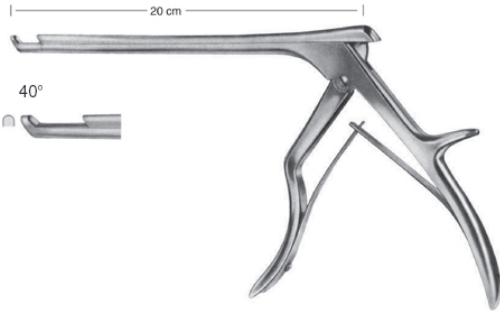

COLCLOUGH
AI-9-137-83
COLCLOUGH
3 mm
5 mm
20 cm,

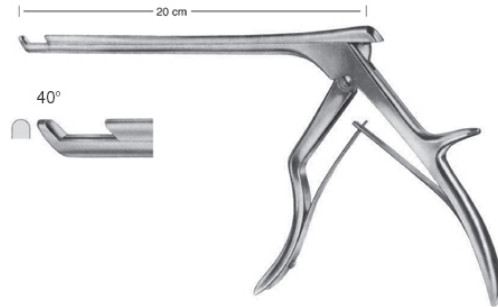

COLCLOUGH
AI-9-137-84
COLCLOUGH
3 mm
5 mm
20 cm,

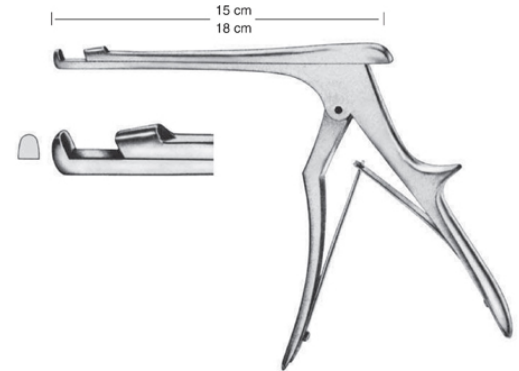

RANEY
AI-9-137-85
RANEY
15 cm / 6mm, 18 cm / 6mm,

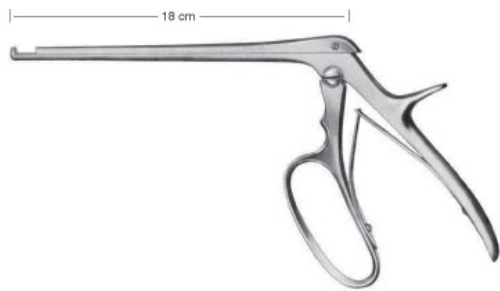

FERRIS-SMITH-KERRISON
AI-9-137-86
FERRIS-SMITH-KERRISON
18 cm,

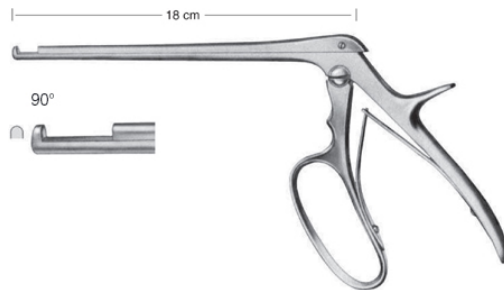

FERRIS-SMITH-KERRISON
AI-9-137-87
FERRIS-SMITH-KERRISON
3x3 mm,

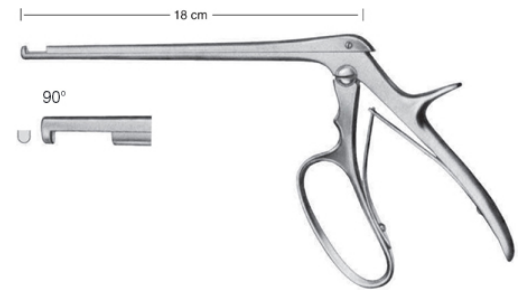

FERRIS-SMITH-KERRISON
AI-9-137-88
FERRIS-SMITH-KERRISON
3x3 mm,

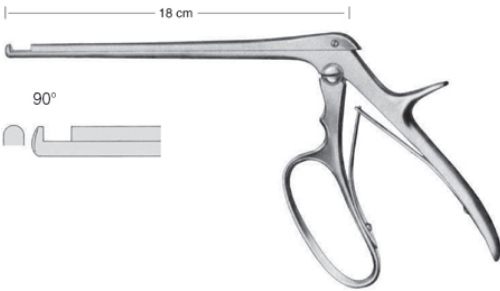

FERRIS-SMITH-KERRISON
AI-9-137-89
FERRIS-SMITH-KERRISON
5x5 mm,

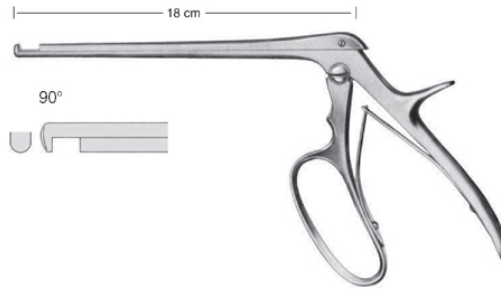

FERRIS-SMITH-KERRISON
AI-9-137-90
FERRIS-SMITH-KERRISON
5x5 mm,

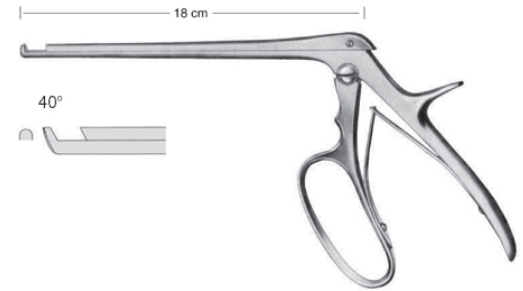

FERRIS-SMITH-KERRISON
AI-9-137-91
FERRIS-SMITH-KERRISON
3 mm,

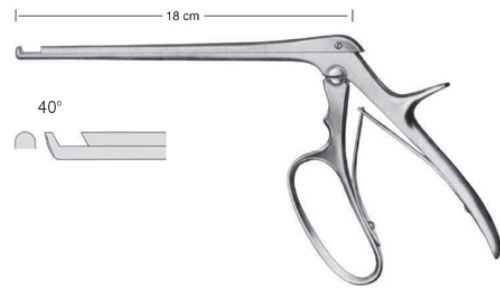

FERRIS-SMITH-KERRISON
AI-9-137-92
FERRIS-SMITH-KERRISON
5 mm,

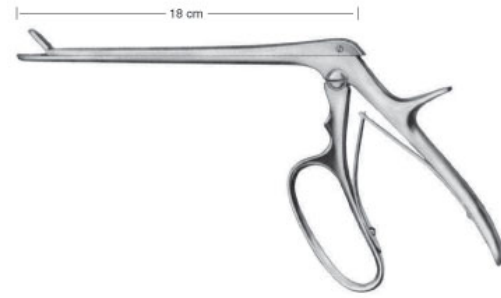

FERRIS-SMITH-CUSHING
AI-9-137-93
FERRIS-SMITH-CUSHING
18 cm,

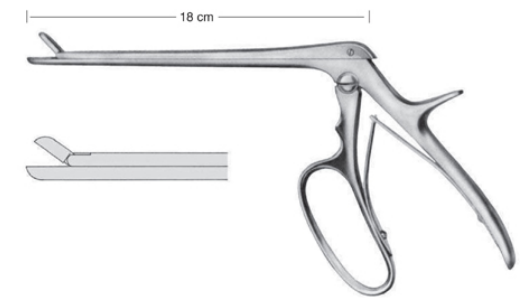

FERRIS-SMITH-CUSHING
AI-9-137-94
FERRIS-SMITH-CUSHING
2 x 10 mm, 3 x 10 mm, 4 x 10 mm, 5 x 10
mm, 6 x 10 mm,

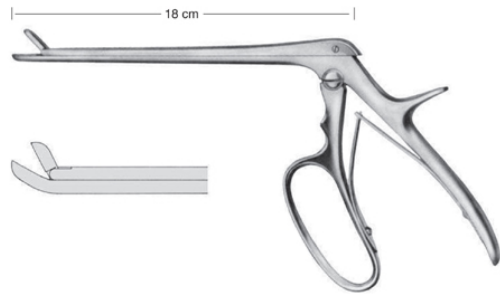

FERRIS-SMITH-CUSHING

AI-9-137-95

FERRIS-SMITH-CUSHING

2 x 10 mm, 3 x 10 mm, 4 x 10 mm, 5 x 10 mm, 6 x 10 mm,

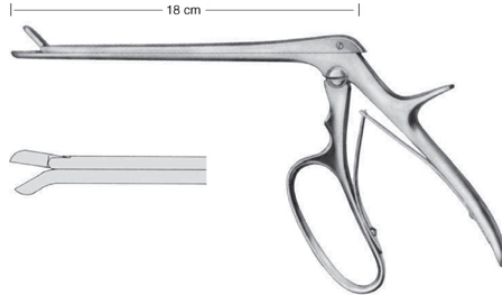

FERRIS-SMITH-CUSHING

AI-9-137-96

FERRIS-SMITH-CUSHING

2 x 10 mm, 3 x 10 mm, 4 x 10 mm, 5 x 10 mm, 6 x 10 mm,

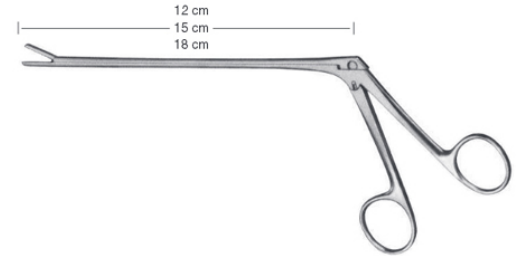

CUSHING

AI-9-137-97

CUSHING

CUSHING

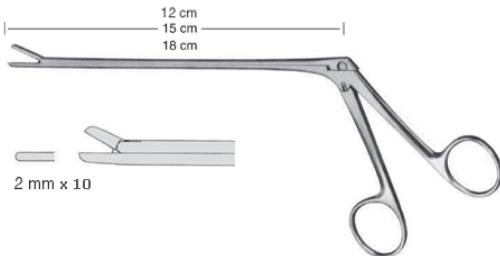

CUSHING

AI-9-137-98

CUSHING

2 mm x 10, 12 cm, 15 cm, 18 cm,

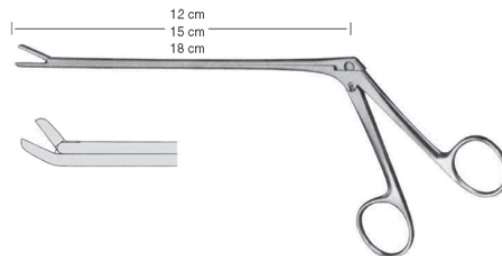

CUSHING

AI-9-137-99

CUSHING

2 mm x 10, 12 cm, 15 cm, 18 cm,

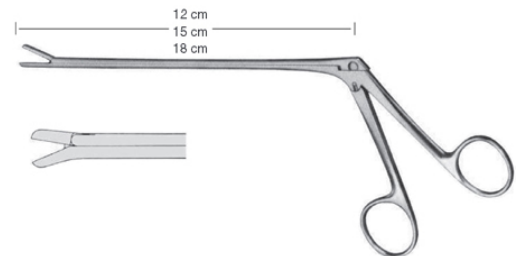

CUSHING

AI-9-137-100

CUSHING

2 mm x 10, 12 cm, 15 cm, 18 cm,

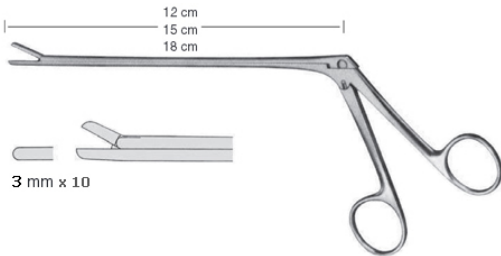

LOVE-GRUENWALD
AI-9-137-101
LOVE-GRUENWALD
3 mm x 10,12 cm,15 cm,18 cm,

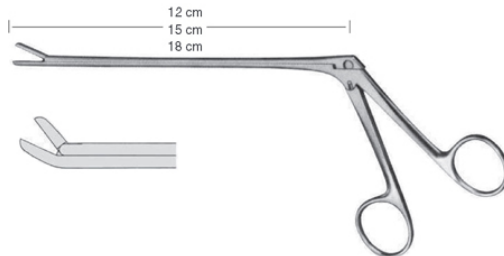

LOVE-GRUENWALD
AI-9-137-102
LOVE-GRUENWALD
3 mm x 10,12 cm,15 cm,18 cm,

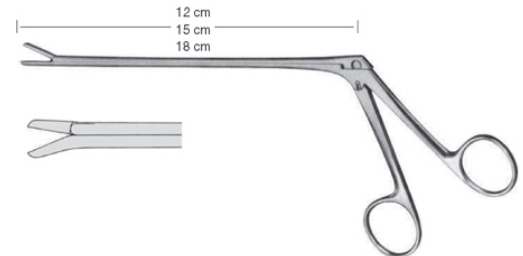

LOVE-GRUENWALD
AI-9-137-103
LOVE-GRUENWALD
3 mm x 10,12 cm,15 cm,18 cm,

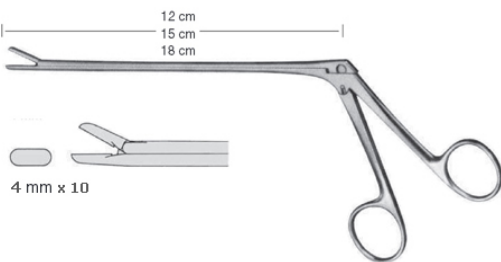

SPURLING
AI-9-137-104
SPURLING
4 mm x 10,12 cm,15 cm,18 cm,

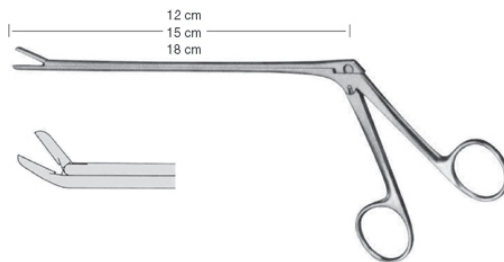

SPURLING
AI-9-137-105
SPURLING
4 mm x 10,12 cm,15 cm,18 cm,

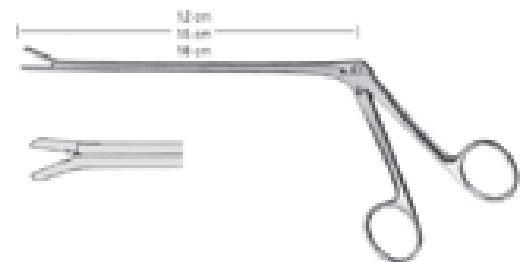

SPURLING
AI-9-137-106
SPURLING
4 mm x 10,12 cm,15 cm,18 cm,



OLDBERG
AI-9-137-107
OLDBERG
18 cm,

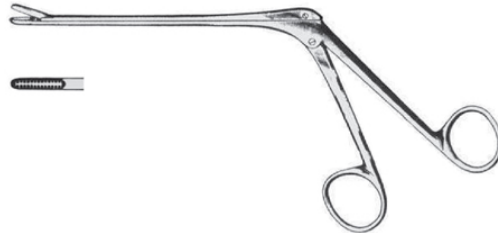

SCHLESINGER
AI-9-137-108
SCHLESINGER
15 cm, 2 x 10 mm, 3 x 10 mm, 4 x 10 mm, 5 x 10 mm,



CASPAR
AI-9-137-109
CASPAR
2 mm, 14 cm, 15 cm, 16 cm, 18.5 cm,



CASPAR
AI-9-137-110
CASPAR
3 mm, 14 cm, 15 cm, 16 cm, 18.5 cm,

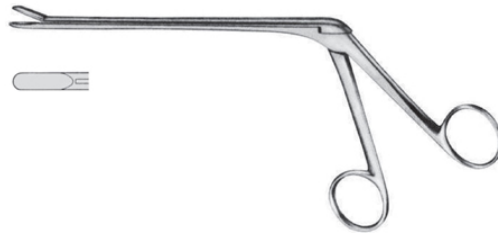

CASPAR
AI-9-137-111
CASPAR
4 mm, 14 cm, 15 cm, 16 cm, 18.5 cm,

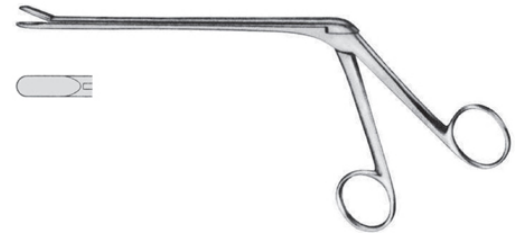

CASPAR
AI-9-137-112
CASPAR
5 mm, 14 cm, 15 cm, 16 cm, 18.5 cm,



CASPAR
AI-9-137-113

CASPAR
2 mm, 14 cm, 15 cm, 16 cm, 18.5 cm,



CASPAR
AI-9-137-114

CASPAR
3 mm, 14 cm, 15 cm, 16 cm, 18.5 cm,



CASPAR
AI-9-137-115

CASPAR
4 mm, 14 cm, 15 cm, 16 cm, 18.5 cm,



CASPAR
AI-9-137-116

CASPAR
2 mm, 14 cm, 15 cm, 16 cm, 18.5 cm,



CASPAR
AI-9-137-117

CASPAR
3 mm, 14 cm, 15 cm, 16 cm, 18.5 cm,



CASPAR
AI-9-137-118

CASPAR
4 mm, 14 cm, 15 cm, 16 cm, 18.5 cm,



YASARGIL

AI-9-137-119

YASARGIL

25 cm, 2.2 cm, 3.5 cm, 4.0 cm,

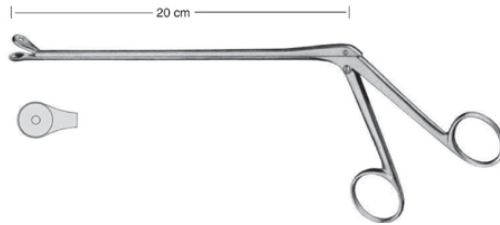

LANDOLT

AI-9-137-120

LANDOLT

27 cm, 9 mm,



OLIVECRONA-TOENNIS

AI-9-137-121

14 cm,



AI-9-101-23
Bone Shear
23 cm,



AI-9-102-22
Rib Shear
23 cm,



Gluck
AI-9-103-22
Rib Shears
21 cm,



Giertz-Stille
AI-9-104-27
Rib Shear
24.5 cm,



Lebsche
AI-9-105-24
Sternum Chisel
24.5 cm,



AI-9-106-01
Rib Retractor lateral blades 12 x 16 mm
spreading 95 mm
Size 1,



Finochietto, Infant

AI-9-107-01

Rib Retractor lateral blades 15 x 15 mm
spreading 75 mm
Size 1,



Finochietto, Baby

AI-9-108-01

Rib Retractor lateral blades 31 x 31 mm
spreading 100 mm
Size 1,



Finochietto

AI-9-109-01

Rib Retractor lateral blades 40 x 45 mm
spreading 135 mm
Size 1,



Burford

AI-9-110-01

Rib Retractor with two pairs of blades 47 x 62
mm + 65 x 62 mm, spreading 200 mm
Size 1,



Castaneda

AI-9-111-01

Rib Retractor lateral blades 10,5 x 32 mm
spreading 65 mm
Size 1,



Finochietto (modif.)

AI-9-112-01

Rib Retractor lateral blades 14 x 15 mm
spreading 120 mm
Size 1,



Haight

AI-9-113-90

Rib Retractor lateral blades 30 x 30 mm
spreading 120 mm
Size 1,



Morse-Favaloro

AI-9-114-01

Sternal Retractor 4 movable blades 17 x 22
mm spreading 160 mm Sternal Retractor
Size 1,



Morse

AI-9-115-00

Sternal Retractor 4 movable blades 22 x 27
mm spreading 200 mm
Size 1,



Tuffier

AI-9-116-02

Rib Retractor lateral blades 22 x 27 mm
spreading 200 mm
Size 1,

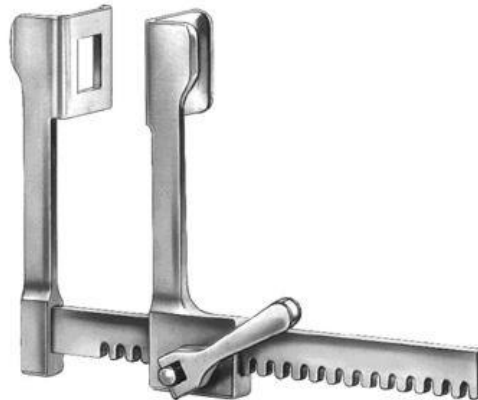

Finochietto, Baby

AI-9-117-75

Rib Retractor lateral blades 14 x 15 mm
spreading 75 mm
Size 1,



Finochietto

AI-9-118-01

Rib Retractor lateral blades 30 x 45 mm
spreading 150 mm
Size 1,



DeBakey

AI-9-119-00

Rib Retractor spreading 150 mm
Size 1,



DeBakey

AI-9-120-00

Rib Retractor spreading 200 mm
Size 1,



AI-9-121-00

Thoracic Retractor
Size 1,



Sellors

AI-9-122-19

Rib Contractor
20 cm,



Bailey-Baby

AI-9-123-14

Rib Contractor
15.5 cm,



Bailey

AI-9-124-16

Rib Contractor
20 cm,



Bailey-Gibbon
AI-9-125-16
Rib Contractor
20 cm,



Allison
AI-9-126-30
Lung Spatula
29.5 cm, 32.5 cm,

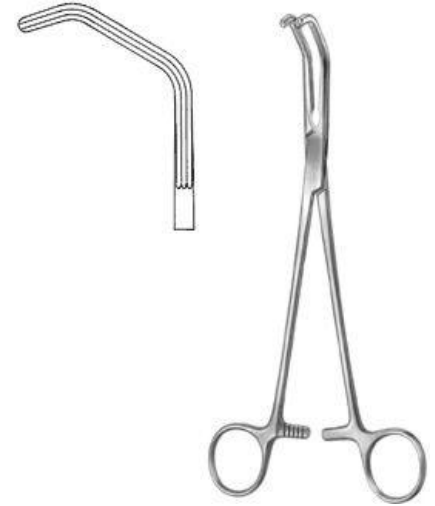

Price-Thomas
AI-9-127-22
Bronchus Clamp
22 cm,

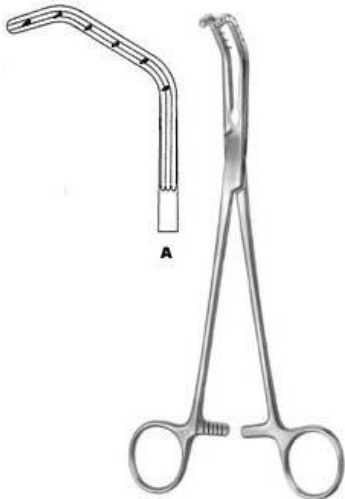

Price-Thomas
AI-9-128-22
Bronchus Clamp
22 cm,

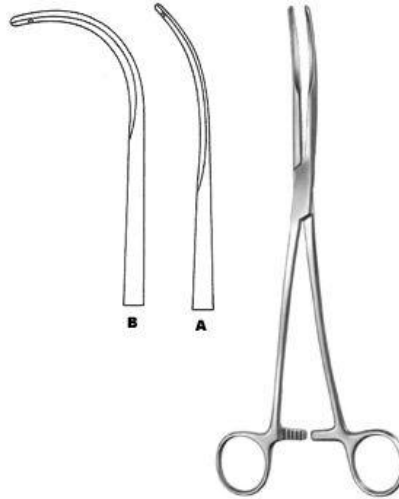

Semb
AI-9-129-24
Bronchus Clamp
24.5 cm,

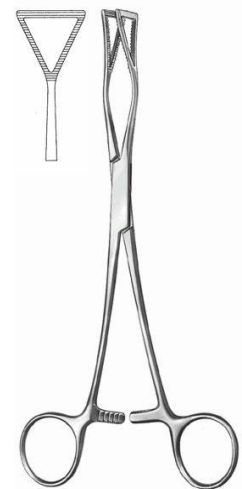

Lovlace
AI-9-130-20
Lung Grasping Forceps
20.5 cm,



Lovelace
AI-9-131-20
Lung Grasping Forceps
19 cm,



DeBakey-Satinsky
AI-9-132-07
Bulldog Clamp
7 cm, 9 cm,



Glover
AI-9-133-06
Bulldog Clamp
6 cm,



Santulli
AI-9-134-07
Bulldog Clamp
7 cm,



Gregory, soft
AI-9-135-09
Bulldog Clamp
9 cm, 11 cm,



Gregory
AI-9-136-01
Bulldog Clamp
10.5 cm,

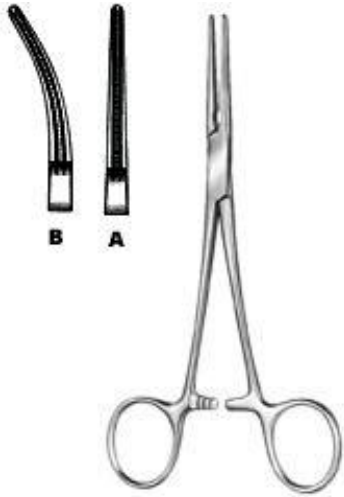

DeBakey-Rankin
AI-9-137-16
Haemostatic Forceps
16 cm,



DeBakey-Mosquito
AI-9-138-15
Haemostatic Forceps
15 cm,



Ochsner
AI-9-139-23
Aortic Clamp
23.5 cm,



Diethrich
AI-9-140-21
Aortic Clamp
22 cm,

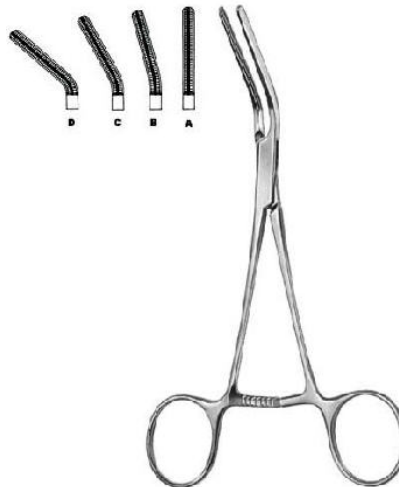

Dardik
AI-9-141-00
Multi purpose Vascular Clamp
15 cm,



Dale
AI-9-142-18
Peripheral Vascular Clamp
18 cm,

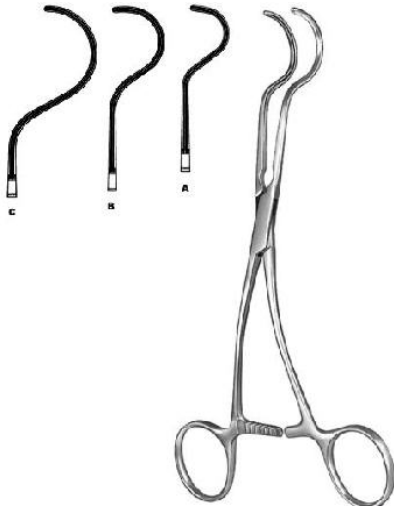

Dale

AI-9-143-17

Peripheral Vascular Clamp
17.5 cm,

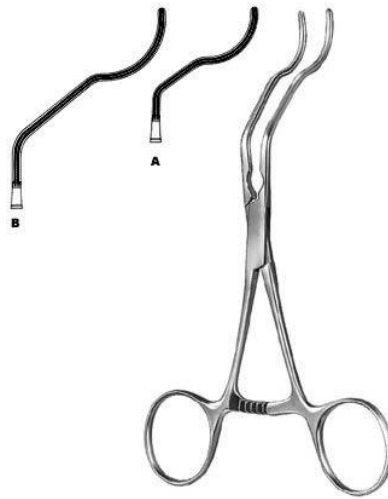

Gregory

AI-9-144-14

Profunda Clamp
13 cm, 16 cm, 18 cm,

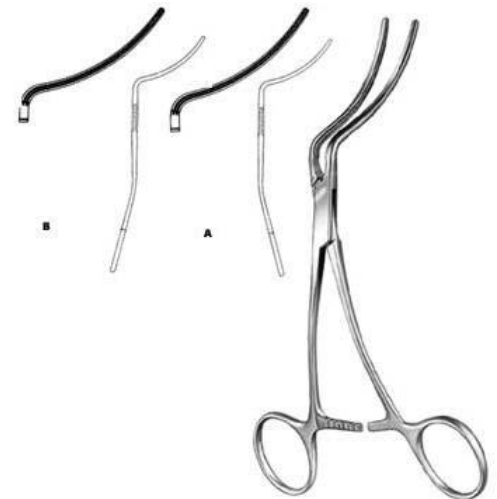

Martin

AI-9-145-16

Peripheral Vascular Clamp
16.5 cm,



Husfeldt

AI-9-146-18

Peripheral Vascular Clamp
17.5 cm,



Husfeldt

AI-9-147-18

Peripheral Vascular Clamp
18 cm,



Husfeldt

AI-9-148-17

Peripheral Vascular Clamp
17 cm,



DeBakey
AI-9-149-16
Vascular Forceps
16 cm,



DeBakey
AI-9-150-16
Vascular Forceps
16 cm,



DeBakey
AI-9-151-16
Vascular Forceps
16 cm,

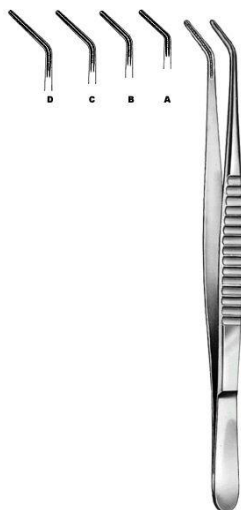

DeBakey
AI-9-152-16
Vascular Forceps
16 cm,



DeBakey
AI-9-153-16
Vascular Forceps
16 cm,



DeBakey
AI-9-154-07
Bulldog Clamp
7.5 cm,



DeBakey
AI-9-155-07
Bulldog Clamp
7.5 cm,



AI-9-156-23
Applying Forceps
23.5 cm,

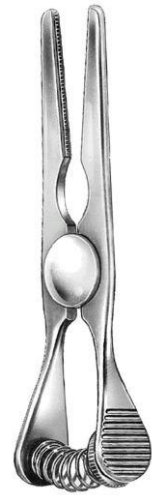

Glover
AI-9-157-06
Bulldog Clamp
7 cm,



Glover
AI-9-158-06
Bulldog Clamp
6.5 cm,

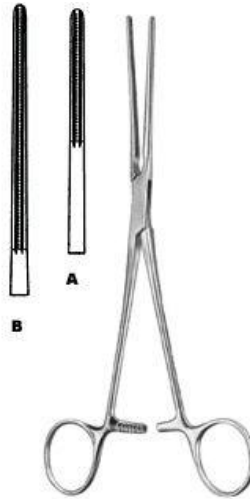

Potts
AI-9-159-21
Coarctation Clamp
21 cm,

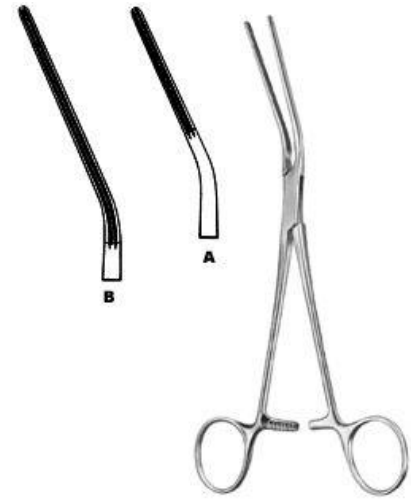

Potts
AI-9-160-21
Coarctation Clamp
20.5 cm,

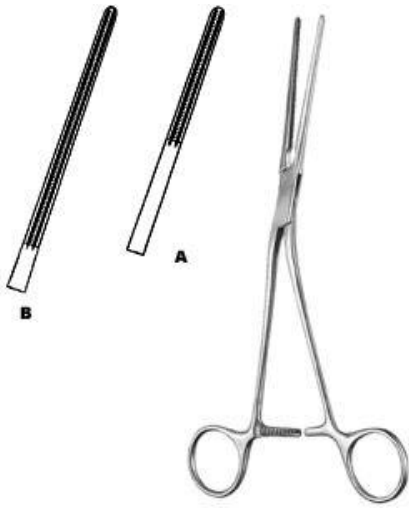

Potts
AI-9-161-21
Coarctation Clamp
20.5 cm,



Potts
AI-9-162-22
Anastomosis Clamp
21.5 cm,



Potts
AI-9-163-22
Anastomosis Clamp
22 cm,

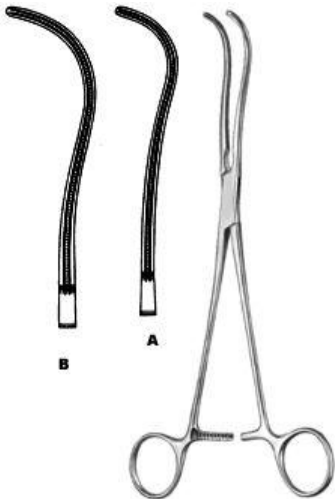

DeBakey
AI-9-164-19
Ligature Forceps
19 cm,



DeBakey
AI-9-165-16
Peripheral Vascular Clamp
16 cm,



DeBakey
AI-9-166-19
Peripheral Vascular Clamp
16 cm,

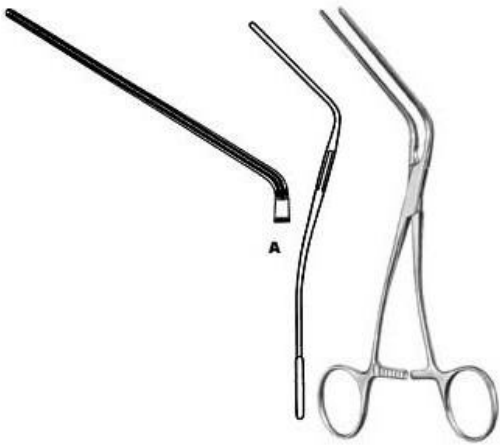

Leland-Jones
AI-9-167-18
Peripheral Vascular Clamp
18 cm,



Bainbridge
AI-9-168-15
Multi purpose Vascular Clamp
15 cm,



Bainbridge
AI-9-169-15
Multi purpose Vascular Clamp
15 cm,

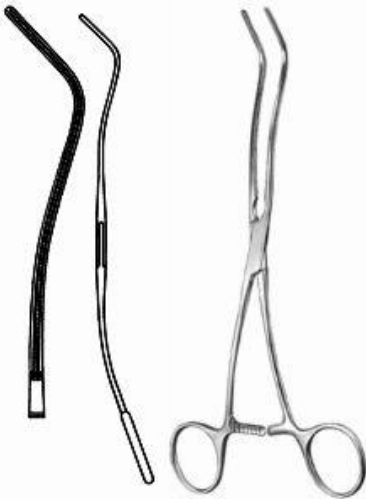

DeBakey
AI-9-170-20
Multi purpose Vascular Clamp
20 cm,



DeBakey
AI-9-171-26
Aortic Aneurysm Clamp
26 cm,



DeBakey
AI-9-172-28
Aortic Aneurysm Clamp
28 cm,



DeBakey
AI-9-173-30
Aortic Aneurysm Clamp
30 cm,



DeBakey
AI-9-174-27
Aortic Clamp
27 cm,



DeBakey
AI-9-175-24
Ligature Forceps
24.5 cm,



DeBakey
AI-9-176-24
Ligature Forceps
24.5 cm,



DeBakey
AI-9-178-25
Ligature Forceps
27 cm,

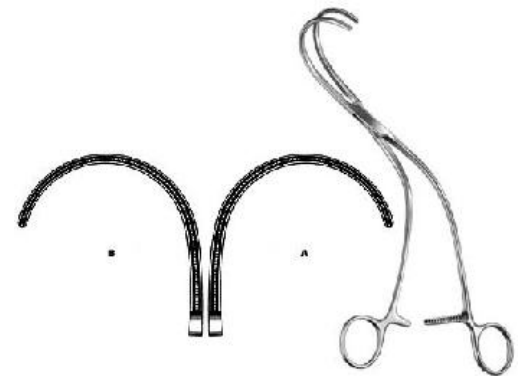

Weber
AI-9-179-01
Aortic Clamp
24 cm,



Satinsky
AI-9-180-20
Tangential Occlusion Clamp
22 cm,



Harken
AI-9-181-01
Auricle Clamp
24.5 cm,



Lees
AI-9-182-23
Bronchus Clamp
23 cm,



Lees
AI-9-183-25
Bronchus Clamp
25 cm,



Lambert-Kay
AI-9-184-21
Anastomosis Clamp
22.5 cm,



DeBakey
AI-9-185-17
Anastomosis Clamp
16.5 cm,



Morris-DeBakey
AI-9-186-18
Aortic Clamp
16.5 cm,



DeBakey-Bahnsen
AI-9-187-23
Aneurysm Clamp
23.5 cm,

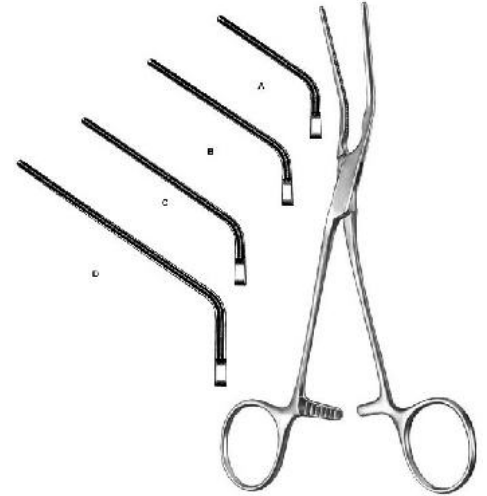

DeBakey
AI-9-188-20
Multi purpose Vascular Clamp
18 cm,

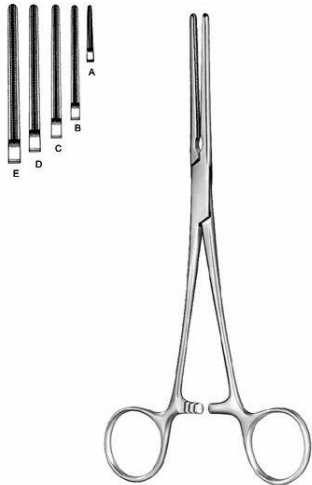

DeBakey-Mosquito
AI-9-189-12
Haemostatic Forceps
12.5 cm,



DeBakey-Mosquito
AI-9-190-12
Haemostatic Forceps
12.5 cm,



DeBakey
AI-9-191-17
Multi purpose Vascular Clamp
17 cm,



DeBakey

AI-9-192-16

Multi purpose Vascular Clamp
16.5 cm,

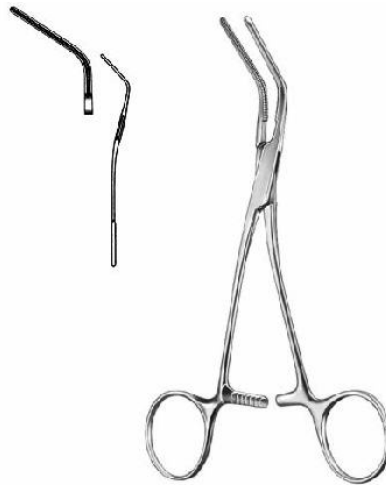

DeBakey

AI-9-193-15

Multi purpose Vascular Clamp
16 cm,

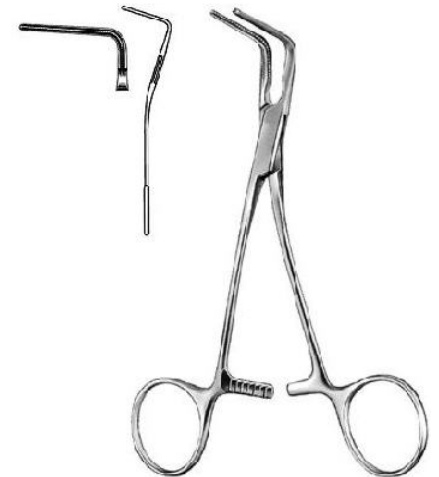

DeBakey

AI-9-194-15

Multi purpose Vascular Clamp
16.5 cm,



DeBakey

AI-9-195-17

Multi purpose Vascular Clamp
16.5 cm,



Glover

AI-9-196-17

Multi purpose Vascular Clamp
17 cm,



Glover

AI-9-197-17

Multi purpose Vascular Clamp
17.5 cm,

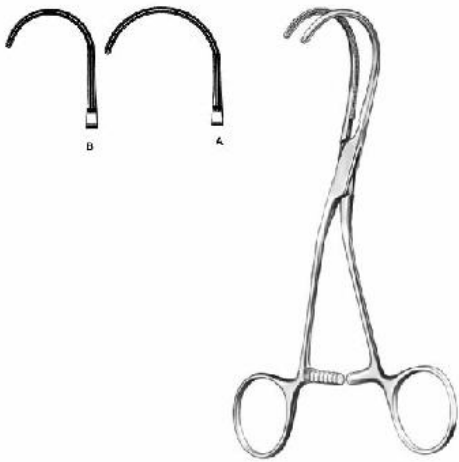

DeBakey

AI-9-198-16

Multi purpose Vascular Clamp
16.5 cm,

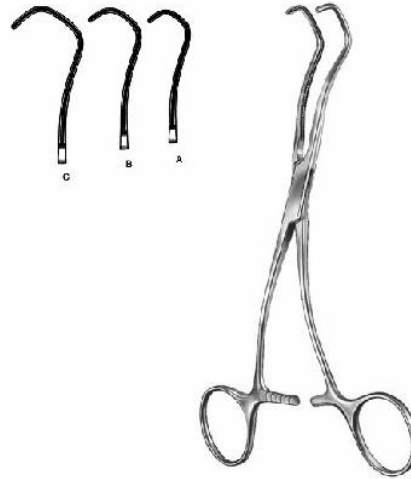

Derra

AI-9-199-16

Anastomosis Clamp
16.5 cm Fig. 1, 17 cm Fig. 2, 18 cm Fig. 3,



DeBakey-Beck

AI-9-200-17

Anastomosis Clamp
17 cm,



Cooley

AI-9-201-16

Vascular Forceps
16 cm,

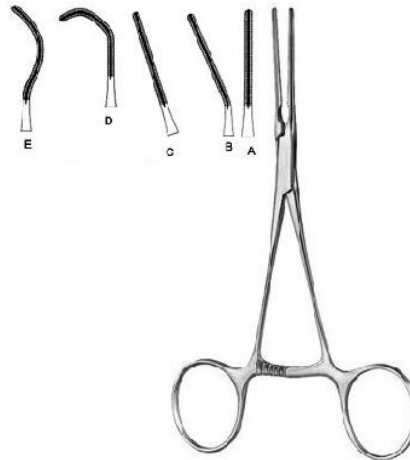

Cooley

AI-9-202-01

Pediatric Vascular Clamp
14.5 cm,



Cooley

AI-9-203-21

Iliac Clamp
22 cm,



Cooley
AI-9-204-17
Anastomosis Clamp
17 cm,

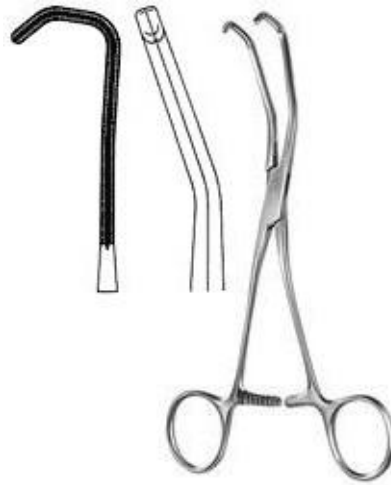

Cooley
AI-9-205-17
Anastomosis Clamp
20 cm,



Cooley
AI-9-206-16
Anastomosis Clamp
17 cm,



Cooley
AI-9-207-15
Multi purpose Vascular Clamp
16 cm,



Cooley
AI-9-208-17
Multi purpose Vascular Clamp
17 cm,



Cooley
AI-9-209-17
Multi purpose Vascular Clamp
17 cm,



Cooley
AI-9-210-17
Multi purpose Vascular Clamp
17.5 cm,

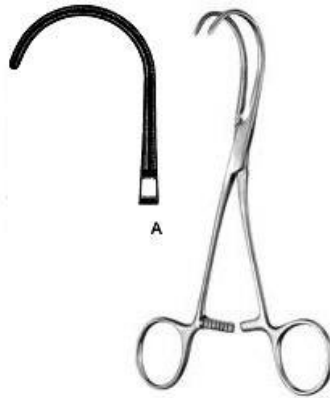

Cooley
AI-9-211-16
Multi purpose Vascular Clamp
16.5 cm,



Cooley-Derra
AI-9-212-16
Anastomosis Clamp
16.5 cm,



Cooley-Beck
AI-9-213-17
Anastomosis Clamp
17 cm,

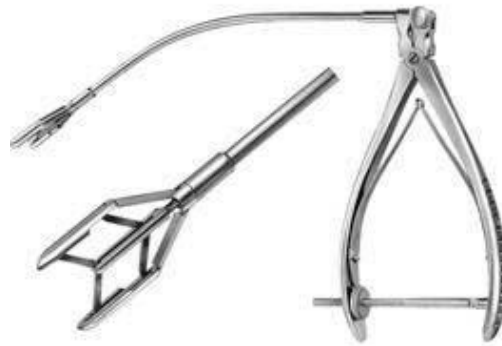

Cooley
AI-9-214-00
Aortic Dilator



Cooley
AI-9-215-05
Vascular Dilator
13 cm 0,5 mm ?,



DeBakey
AI-9-216-05
Vascular Dilator
19 cm 0,5 mm ?,

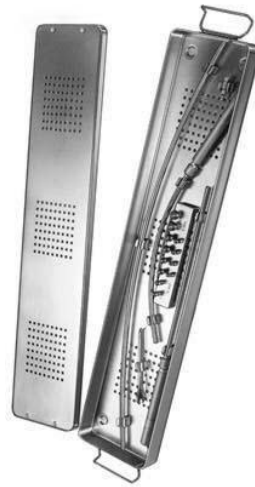

Martin
AI-9-217-00
Tunneling Set complete set with three shafts,
two handles and 12 tips in storage case.



Hach
AI-9-218-01
Fasciotomy Knife with plastic handle
30 cm,



AI-9-219-18
Intima Spatula
18.5 cm,

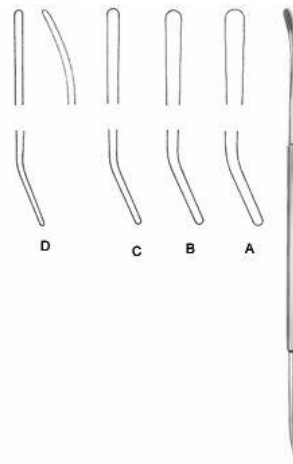

Robb
AI-9-220-01
Vascular Dissector
24 cm Fig. 1 2,5 mm ?, 24 cm Fig. 2 2,0 mm
?,



Crile
AI-9-221-20
Nerve Hooklet
20 cm,

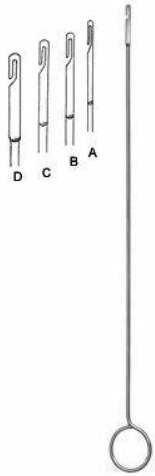

AI-9-222-15
Ligature Catcher
26 cm 1,5 mm,



Subramanian-Miniature
AI-9-223-15
Aortic Clamp 135 degree
15.5 cm,

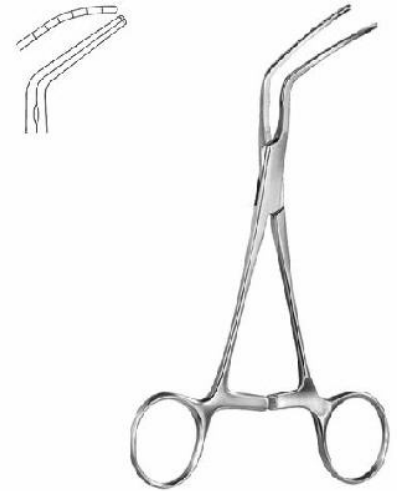

Subramanian
AI-9-224-16
Aortic Clamp
16 cm,

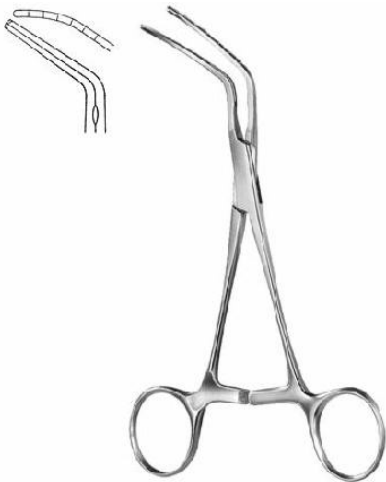

Subramanian
AI-9-225-16
Aortic Clamp
13.5 cm Fig. 1, 13.5 cm Fig. 2, 14 cm Fig. 3,

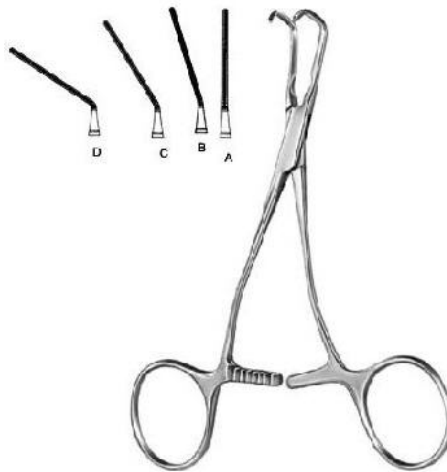

AI-9-226-01
Pediatric Vascular Clamp



AI-9-227-16
Pediatric Vascular Clamp
16.5 cm,



AI-9-228-16
Pediatric Vascular Clamp
16 cm,

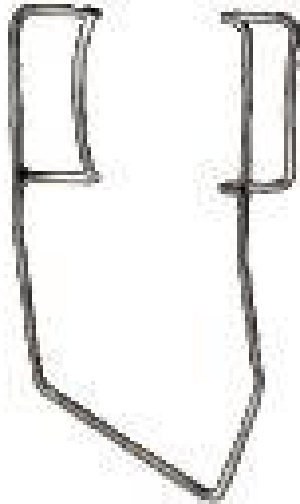

Barraquer (Colibri)
AI-11-101-03
Barraquer
Size 1,

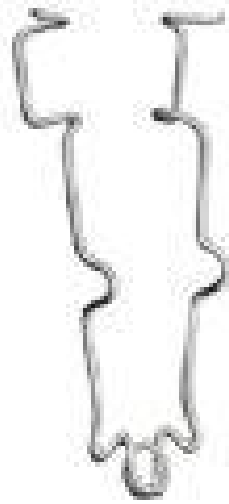

AI-11-102-07
Bowman
Size 1,



AI-11-103-06
Critchett
Size 1,



AI-11-104-05
Smith
Size 1,

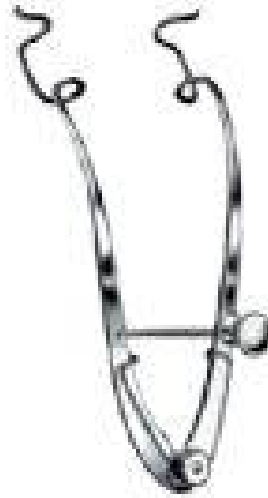

AI-11-105-08
Clark
Size 1,



AI-11-106-06
Graefe
Size 1,



AI-11-107-08
Week
Size 1,



AI-11-108-07
Arruga
Size 1,



AI-11-109-07
Arruga
Size 1,



AI-11-110-05
Murdock
Size 1,



Millinger
AI-11-111-07
Mellinger Axenfeld
Size 1,



Millinger
AI-11-112-07
Mellinger Axenfeld
Size 1,



Millenger
AI-11-113-07
Mellinger
Size 1,



AI-11-114-08
Lister Burch
Size 1,



Williams Eye Speculum
AI-11-115-08
Williams
7 cm, 8.3 cm,



Lancaster
AI-11-116-07
Lancaster
Size 1,



AI-11-118-08
Ziegler
Size 1,

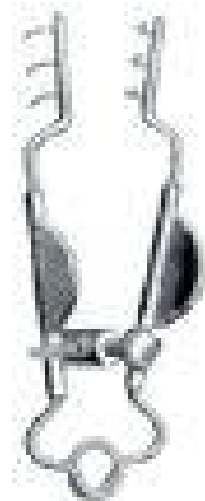

Mueller
AI-11-120-07
Mueller
Size 1,



Jaeger Lid Plate
AI-11-121-11
Jaeger
4", 20mm, 23mm,



VON GRAEFE Knife
AI-11-122-03
Graefe
1, 2, 3, 4, 5,



AI-11-123-01
Jaeger
Size 1,



AI-11-124-13
Berens
Size 1,

ZIEGLER knife Needle
AI-11-126-01
Ziegler
11.4 cm,



Castroviejo Cyclodialysis Spatula
AI-11-127-12
Castroviejo
13.3 cm,



AI-11-128-12
Wheeler
Size 1,



Castroviejo Cyclodialysis Spatula
AI-11-129-05
Castroviejo
Size 1,



AI-11-130-12
Dix
Size 1,



AI-11-131-13
Dix
Size 1,



AI-11-132-13
Dix
Size 1,



Castroviejo Caliper
AI-11-133-07
Castroviejo
8.3 cm,



AI-11-134-13
Connin Amsler
Size 1,



AI-11-135-06
Dastoor
Size 1,



AI-11-136-09
Holth
Size 1,



Wilder Lacrimal Dilator
AI-11-137-03
Wilder
10.2 cm,



ZIEGLER Lacrimal Dilator
AI-11-138-12
Ziegler
14 cm Double End,



Castroviejo Lacrimal Dilator
AI-11-139-12
Castroviejo
14 cm,



AI-11-140-78
Bowman
Size 1,



AI-11-141-07
Graefe
Size 1,



AI-11-142-07
Graefe
Size 1,



AI-11-143-07
Graefe
Size 1,



AI-11-144-07
Graefe
Size 1,



AI-11-145-07
Fischer
Size 1,



AI-11-146-07
Barraquer Katzin
Size 1,



AI-11-147-07
Troutman
Size 1,



AI-11-148-07
Barraquer
Size 1,



AI-11-149-07
Barraquer
Size 1,



AI-11-150-09
McCullough
Size 1,



AI-11-151-09
McCullough
Size 1,



AI-11-152-10
Jameson
Size 1,



AI-11-153-10
Jameson
Size 1,



AI-11-154-10
Bonaccolto
Size 1,



AI-11-155-10
Bonaccolto
Size 1,



AI-11-156-10
Dastoor
Size 1,



AI-11-157-10
Dastoor
Size 1,



AI-11-158-05
Bishop Harman
Size 1,



AI-11-159-08
Bishop Harman
Size 1,



AI-11-160-05
Bishop Harman
Size 1,



AI-11-161-08
Bishop Harman
Size 1,



AI-11-162-07
Mod Bonn
Size 1,



AI-11-163-07
Mod Bonn
Size 1,



AI-11-164-10
Mod Bonn
Size 1,



AI-11-165-10
Mod Bonn
Size 1,



AI-11-166-10
Mod Bonn
Size 1,



AI-11-167-10
Mod Bonn
Size 1,



AI-11-168-10
Prince
Size 1,



AI-11-169-10
Prince
Size 1,



AI-11-170-20
Berke
Size 1,



AI-11-171-08
Troutman
Size 1,



AI-11-172-05
Barraquer
Size 1,



AI-11-173-11
Elsching
Size 1,



AI-11-174-11
Graefe
Size 1,



AI-11-175-09
Lester
Size 1,



AI-11-176-09
Castroviejo
Size 1,



AI-11-178-09
Castroviejo
Size 1,



AI-11-179-09
Barraquer
Size 1,



AI-11-180-10
Green
Size 1,



AI-11-181-07
Gill Arruga
Size 1,



AI-11-182-01
Castroviejo
Size 1,



AI-11-183-05
Castroviejo
Size 1,



AI-11-184-10
Moorfield
Size 1,



AI-11-185-07
St Martin
Size 1,



AI-11-186-10
Mod Tubingen
Size 1,



AI-11-187-10
McPherson
Size 1,



AI-11-188-10
McPherson
Size 1,



AI-11-189-09
Ayer
Size 1,



AI-11-190-09
Ayer
Size 1,



AI-11-191-09
Desmarres
Size 1,



AI-11-192-10
Snellen
Size 1,



AI-11-1193-11
Knapp Luer
Size 1,



AI-11-194-28
Scheie
Size 1,



AI-11-195-45
Mod Tubingen
Size 1,



AI-11-196-00
Elliot
Size 1,

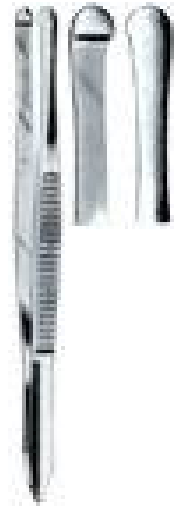

AI-11-197-09
Beer
Size 1,

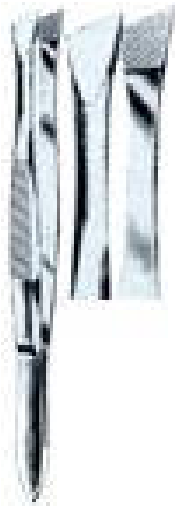

AI-11-198-10
Barraquer

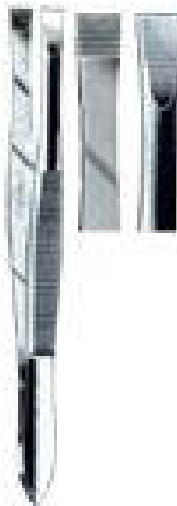

AI-11-199-09
Douglas
Size 1,



AI-11-200-09
Gradle
Size 1,



AI-11-177-09
Castroviejo
Size 1,

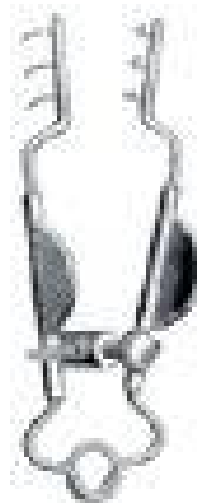

AI-11-119-07
Mueller
Size 1,

Tracheotomy

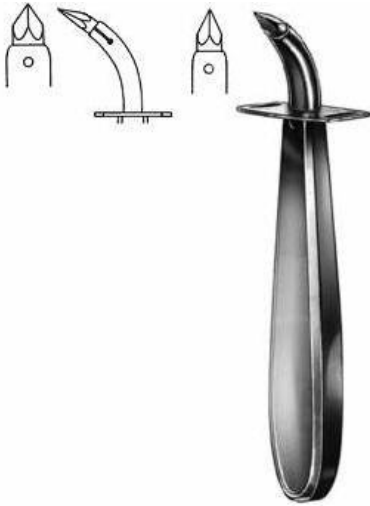

Ueckermann
AI-16-101-13
Tracheotomy Trocar
11.5 cm,



Iterson
AI-16-102-16
Tracheal Hook
17 cm,



Rose
AI-16-103-13
Tracheal Hook
13.5 cm,



Luer
AI-16-104-11
Tracheal Hook
11 cm,



AI-16-105-15
Tracheal Hook
15 cm,



Lukens
AI-16-106-17
Thymus Retractor
17.5 cm,



Jackson
AI-16-107-17
Tracheal Hook
18 cm,



Kocher
AI-16-108-15
Goitre Enucleator
16.5 cm,



Kocher
AI-16-109-15
Goitre Enucleator
16.5 cm,



Hofmeister
AI-16-110-21
Goitre Enucleator
20.5 cm,

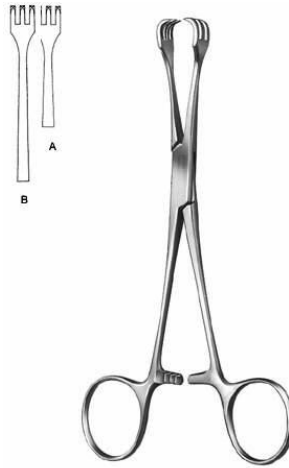

Lahey
AI-16-111-15
Goitre Grasping Forceps
15.5 cm,



Luer
AI-16-112-04
Tracheal Tube



Luer
AI-16-113-08
Tracheal Tube



Chevalier-Jackson
AI-16-114-04
Tracheal Tube outer tube closed inner tube
closed silver



AI-16-115-08
Speaking Tube



Moncorps
AI-17-101-14
Milium Knife
14 cm,



Moncorps
AI-17-102-00
Spare Blade



Vidal
AI-17-103-14
Lupus Scraper
13 cm,



Wolff
AI-17-105-01
Lupus Curette
14 cm,



Kilner
AI-17-106-15
Skin Hooklet
14.5 cm,



Gillies
AI-17-107-18
Skin Hooklet
18 cm,



Kaye
AI-17-108-03
Face-lift Hook
13 cm,

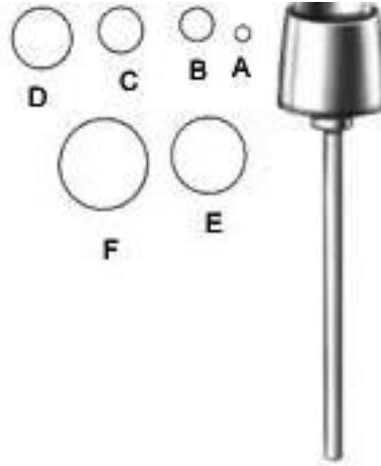

AI-17-109-02
Dermal Punch
5.5 cm,



Handle
AI-17-110-00
8 cm,

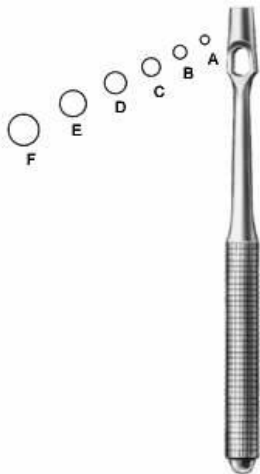

Keyes
AI-17-111-02
Dermal Punch
11 cm,



Unna
AI-17-113-14
Comedone Extractor
14.5 cm,



Saalfeld
AI-17-114-10
Comedone Extractor
11 cm,



Saalfeld
AI-17-115-14

Saalfeld Comedone Extractor
14.5 cm,



Schamberg
AI-17-116-10
Comedone Extractor
9.5 cm,



Katsch
AI-17-117-14
Comedone Extractor
16 cm,



Unna-Vidal
AI-17-118-11
Comedone Extractor
11.5 cm,



d'Assump?
AI-17-119-15
Face-lift Forceps
18 cm,



Gregory
AI-17-120-14
Face-lift Scissors
14 cm,



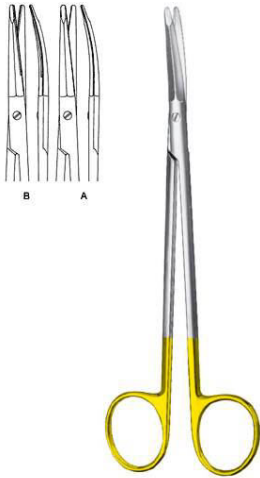

Kaye
AI-17-121-15
Face-lift Scissors
15 cm, 18 cm,



Stella-S
AI-17-122-18
Face-lift Scissors
18 cm,

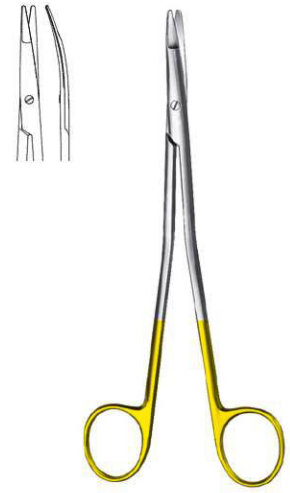

Gorney
AI-17-123-18
Face-lift Scissors
18 cm,

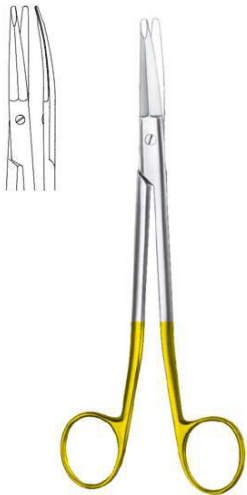

Freeman-Kaye
AI-17-124-18
Face-lift Scissors
18 cm,

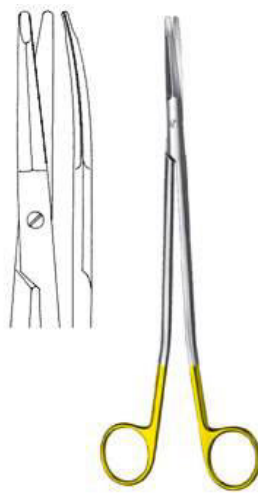

Freeman
AI-17-125-00
Face-lift Scissors
23 cm,



Fox
AI-17-104-01
Lupus Curette
14 cm,

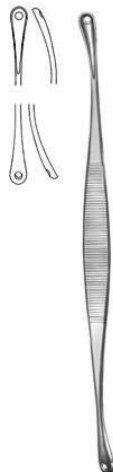

Unna
AI-17-112-14
Comedone Extractor
14.5 cm,



Allis-Baby

AI-18-101-12

Intestinal and Tissue Grasping Forceps
13 cm,

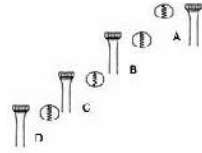

Allis

AI-18-102-15

Intestinal and Tissue Grasping Forceps
15.5 cm, 19 cm, 25.5 cm,

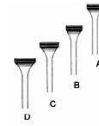

Allis

AI-18-103-16

Intestinal and Tissue Grasping Forceps
15.5 cm, 20 cm, 24.5 cm, 30 cm,

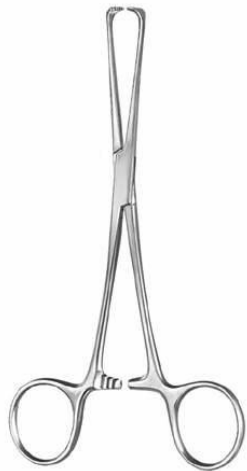

Allis-Adair

AI-18-104-15

Intestinal and Tissue Grasping Forceps
16 cm,



Boys-Allis

AI-18-105-15

Intestinal and Tissue Grasping Forceps
15.5 cm,



Thoms-Allis

AI-18-106-20

Intestinal and Tissue Grasping Forceps
20.5 cm,



Allis
AI-18-107-20

Intestinal and Tissue Grasping Forceps
20 cm,



Lockwood
AI-18-108-20

Intestinal and Tissue Grasping Forceps
20 cm,



Williams
AI-18-109-16

Intestinal and Tissue Grasping Forceps
16.5 cm,

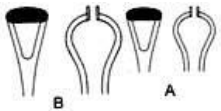

Babcock
AI-18-110-16

Intestinal and Tissue Grasping Forceps
16.5 cm, 21 cm,

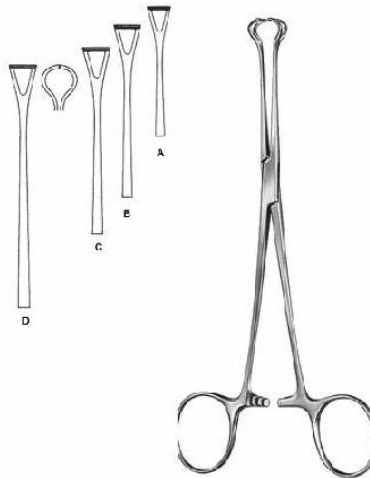

Babcock
AI-18-111-16

Intestinal and Tissue Grasping Forceps
15.5 cm, 17.5 cm, 21 cm, 24 cm,

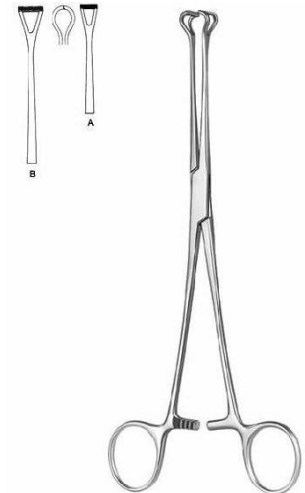

Babcock
AI-18-112-16

Intestinal and Tissue Grasping Forceps
16 cm, 20.5 cm,

Intestines & Stomach



Duval
AI-18-113-20

Intestinal and Tissue Grasping Forceps
20.5 cm,

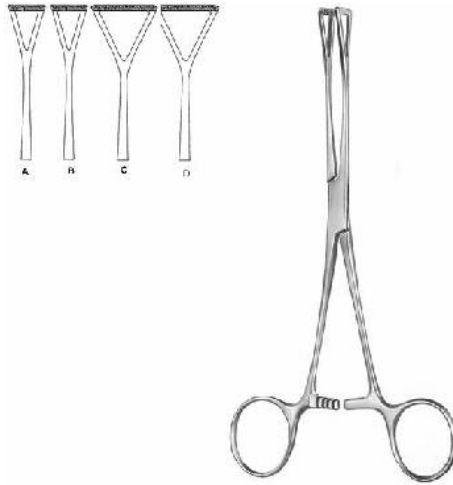

Duval
AI-18-114-18

Intestinal and Tissue Grasping Forceps
18 cm, 20.5 cm, 23 cm,

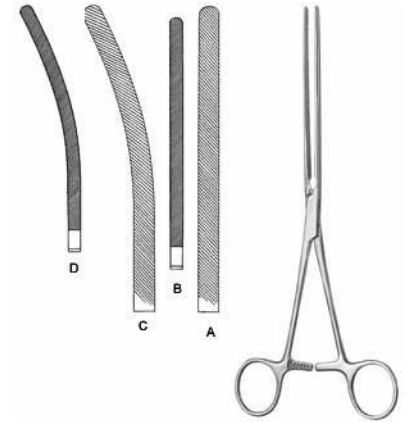

Doyen
AI-18-115-21

Intestinal Clamp
21.5 cm, 23.5 cm,

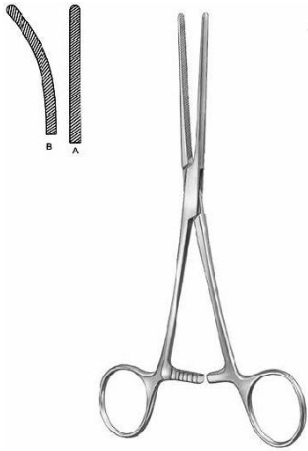

Doyen-Baby
AI-18-116-18

Intestinal Clamp
18 cm, 17.5 cm,

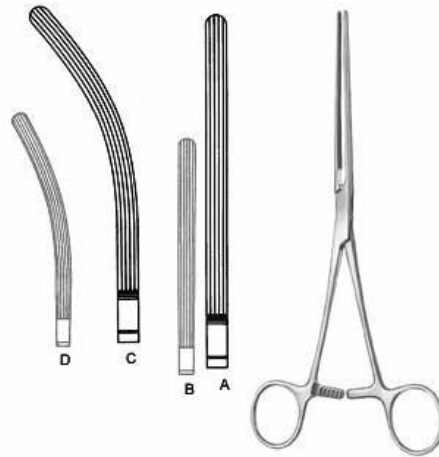

Mayo-Robson
AI-18-117-21

Intestinal Clamp
21.5 cm, 23.5 cm, 23 cm,

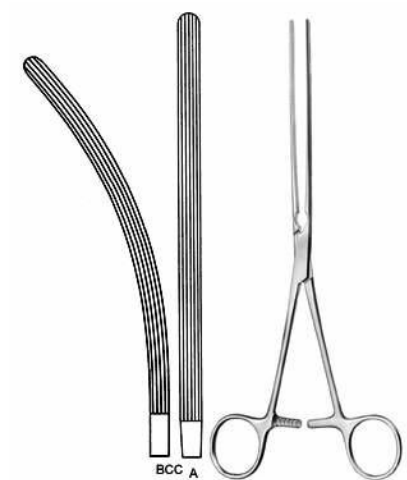

Mayo-Robson
AI-18-118-25

Intestinal Clamp
25.5 cm, 24.5 cm,

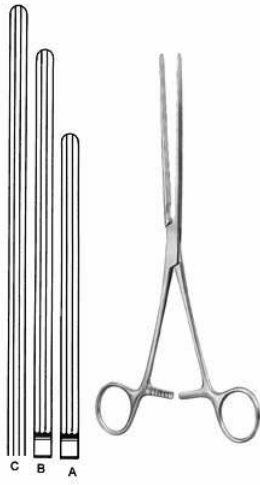

Kocher

AI-18-119-22

Intestinal Clamp
22.5 cm, 25 cm, 28.5 cm,

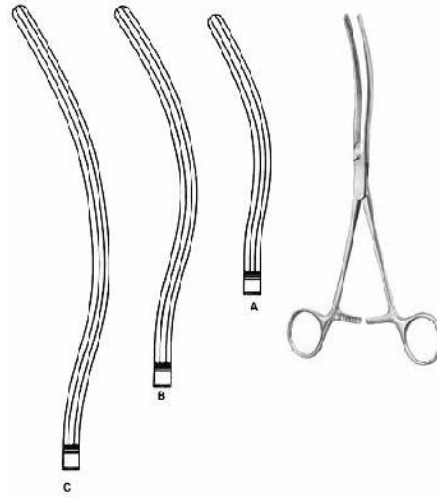

Kocher

AI-18-120-22

Intestinal Clamp
22 cm, 24.5 cm, 27.5 cm,



Allen

AI-18-121-16

Intestinal Clamp
16 cm,



Payr-Baby

AI-18-122-15

Intestinal and Pylorus Clamp
15 cm,

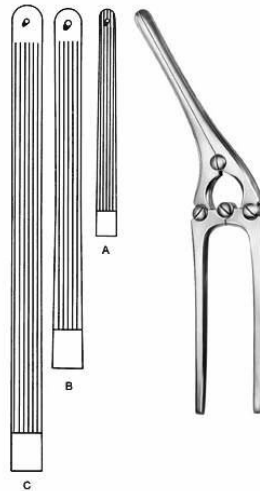

Payr

AI-18-123-21

Intestinal and Pylorus Clamp
20.5 cm, 29 cm, 34.5 cm,



Stone-Watt

AI-18-124-07

Intestinal Anastomosis Clamp
8.5 cm, 10 cm,

Intestines & Stomach



Stone-Watt
AI-18-125-15
Closing Forceps

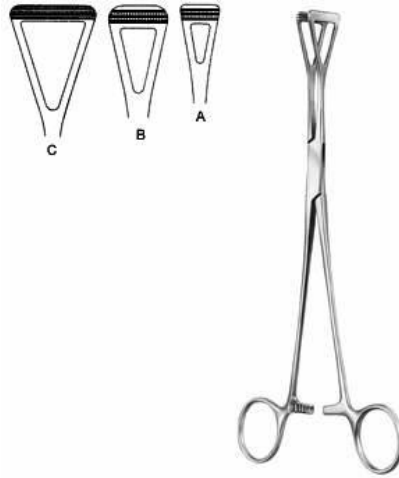

Scheibe
AI-18-126-18
Organ Grasping Forceps
18 cm,

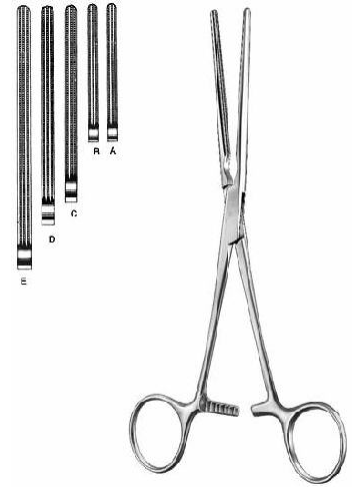

Doyen-Baby
AI-18-127-13
Intestinal Clamp
14 cm, 17 cm,

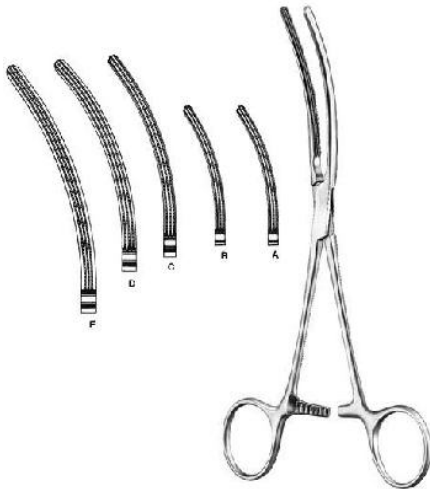

Doyen-Baby
AI-18-128-13
Intestinal Clamp
13.5 cm, 17 cm,



Mayo-Robson
AI-18-129-25
Intestinal Clamp
26 cm,



Mayo-Robson
AI-18-130-25
Intestinal Clamp
25 cm,

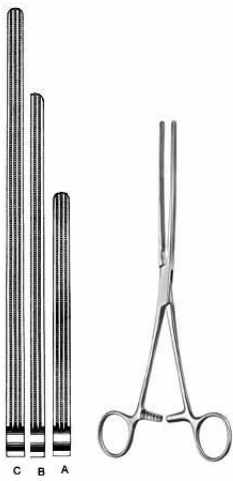

Kocher
AI-18-131-22
Intestinal Clamp
22.5 cm, 28 cm,

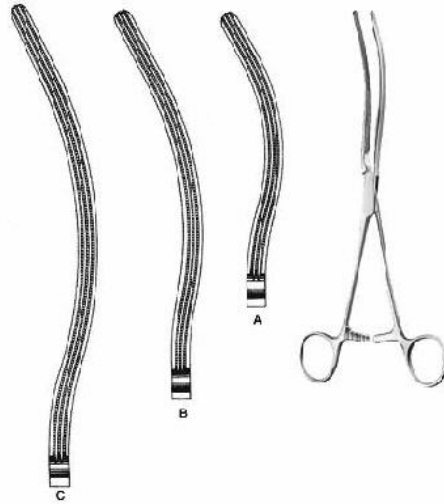

Kocher
AI-18-132-22
Intestinal Clamp
22 cm, 25 cm, 27.5 cm,

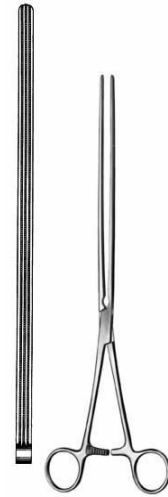

Scudder
AI-18-133-33
Intestinal Clamp
33.5 cm,

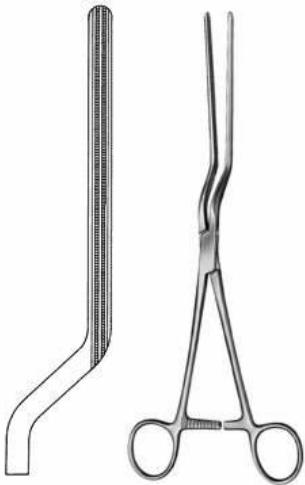

Brunner
AI-18-134-24
Sigmoid Anastomosis Forceps
27 cm,

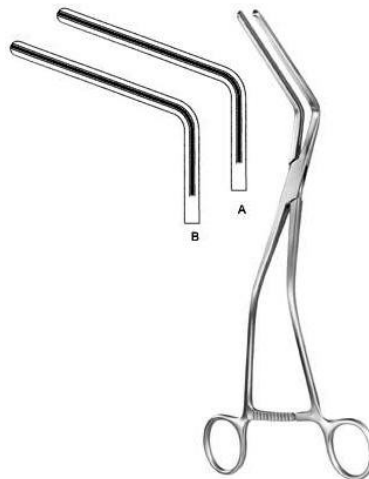

Hayes
AI-18-135-26
Sigmoid Anastomosis Forceps
27 cm, 28 cm,



Veidenheimer
AI-18-136-23
Sigmoid Anastomosis Forceps
25 cm,

Intestines & Stomach



Fehland
AI-18-137-24
Sigmoid Anastomosis Forceps
24 cm,

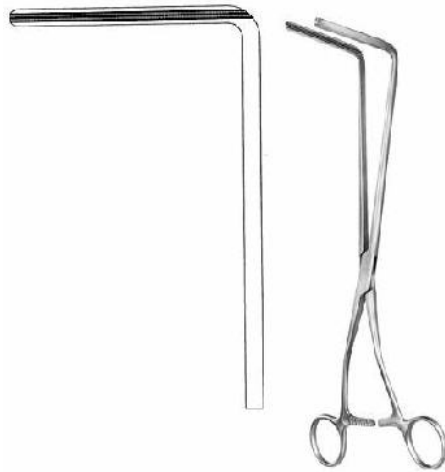

Resano
AI-18-138-30
Sigmoid Anastomosis Forceps
28 cm,



Sims
AI-18-139-15
Rectal Speculum
15.5 cm,



Sims
AI-18-140-15
Rectal Speculum
15.5 cm,



Mathieu
AI-18-141-19
Rectal Speculum
19 cm,



Alan-Parks
AI-18-142-00
Alan-Parks
14 cm,

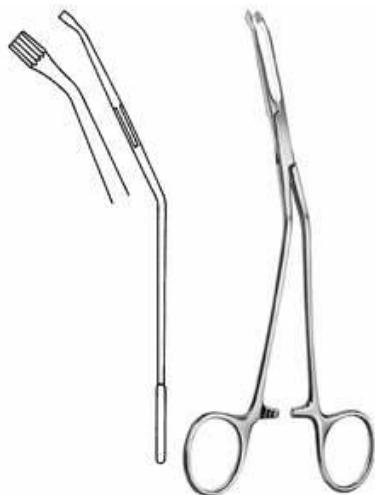

McGinvey

AI-18-143-19

Hemorrhoidal Grasping Forceps
19 cm,



AI-18-144-00

Handle for biopsy forceps



AI-18-145-38

Rectal Biopsy Forceps

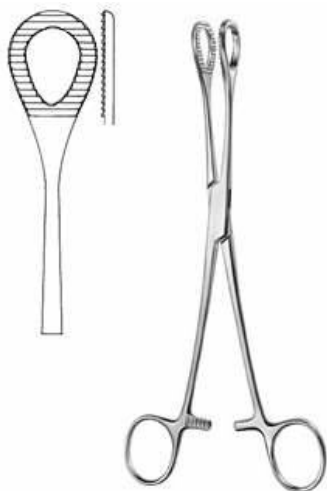

Heywood-Smith

AI-18-146-21

Polypus Grasping Forceps
21 cm,

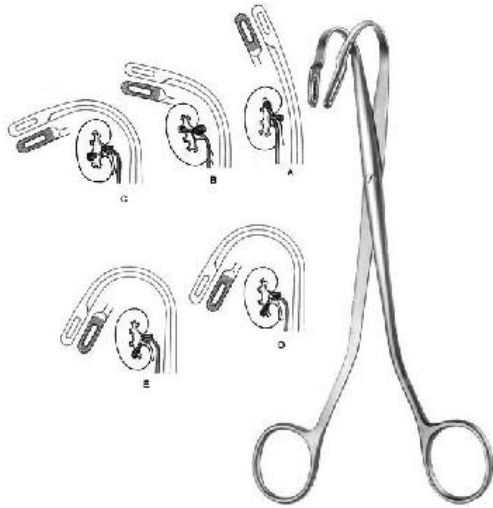

Randall

AI-19-101-23 A

Kidney Stone Forceps

23 cm Fig. 1, 21 cm Fig. 2, 19 cm Fig. 3,

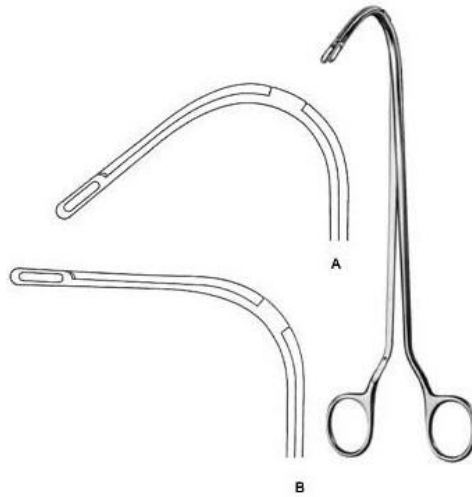

Randall

AI-19-102-23 A

Kidney Stone Forceps

23 cm, 24.5 cm,

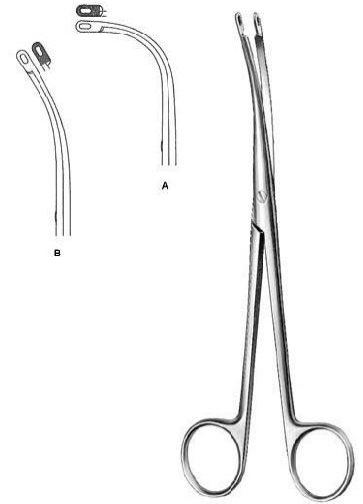

Heiming

AI-19-103-16 A

Kidney Stone Forceps

16 cm Fig. 1, 17 cm Fig. 2,

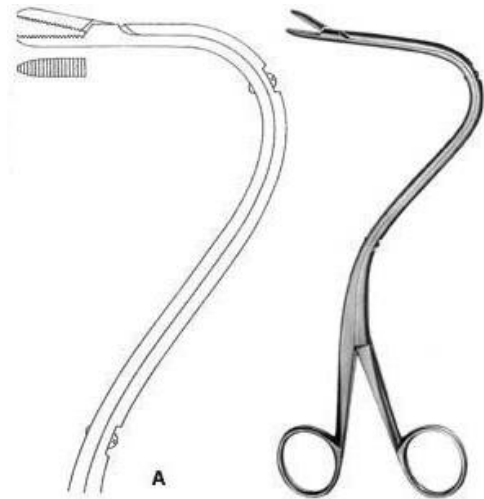

Elsasser

AI-19-104-01 A

Nephrostomy Forceps

21 cm Fig. 1, 21 cm Fig. 2,

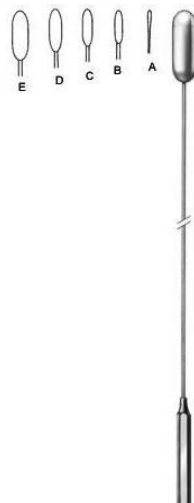

Bakes

AI-19-105-01 A

Gall Duct Dilator

32 cm,

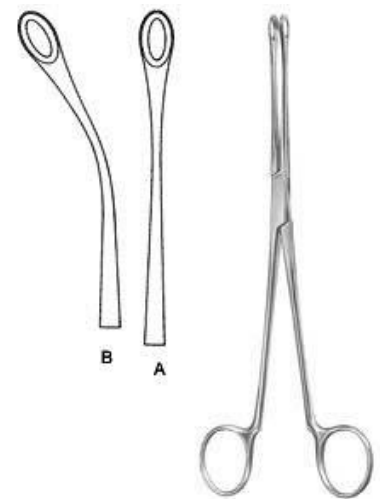

Blake

AI-19-106-20 A

Gall Stone Forceps

21 cm,



Mayo-Blake
AI-19-107-20
Gall Stone Forceps
21 cm,



Mayo-Blake
AI-19-108-20
Gall Stone Forceps
21 cm,



Mixer
AI-19-109-22
Gall Stone Forceps
21.5 cm,



Desjardins
AI-19-110-23 A
Gall Stone Forceps
23 cm,

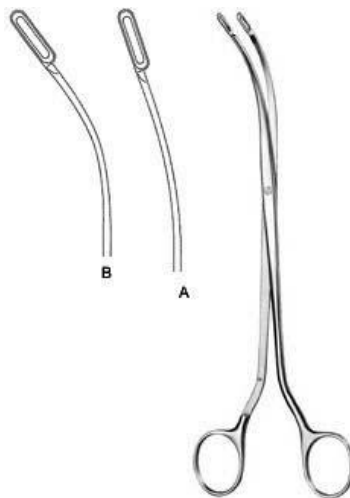

Desjardins
AI-19-111-24 A
Gall Stone Forceps



Luer-Korte
AI-19-112-01 A
Gall Stone Scoop
32 cm Fig. 0, 32 cm Fig. 00, 32 cm Fig. 000, 32 cm Fig. 1, 32 cm Fig. 2, 32 cm Fig. 3, 32 cm Fig. 4,

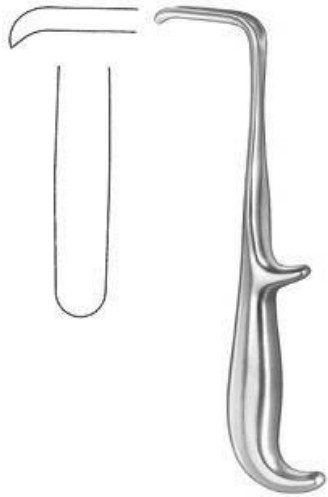

Young
AI-19-113-21
Prostatic Retractor
21.5 cm,



Young
AI-19-114-22
Prostatic Retractor
20.5 cm,



Young
AI-19-115-21
Prostatic Retractor
22 cm,

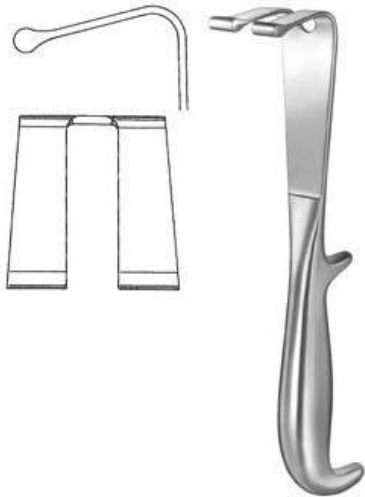

Young
AI-19-116-22
Prostatic Retractor
21.5 cm,



Millin
AI-19-117-24
Capsule Forceps
24.5 cm,

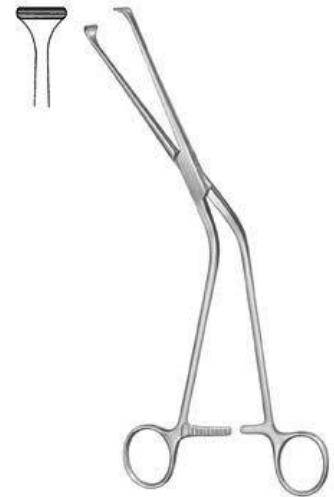

Millin
AI-19-118-24
Capsule Forceps
22 cm,

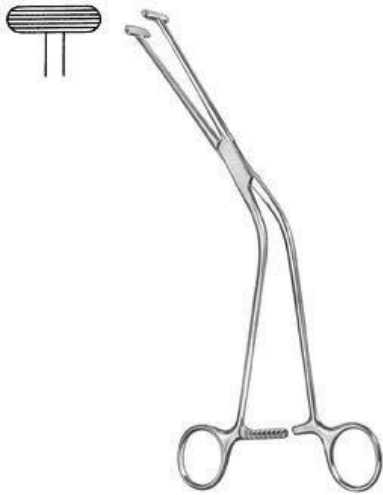

Millin
AI-19-119-23
Capsule Forceps
24.5 cm,

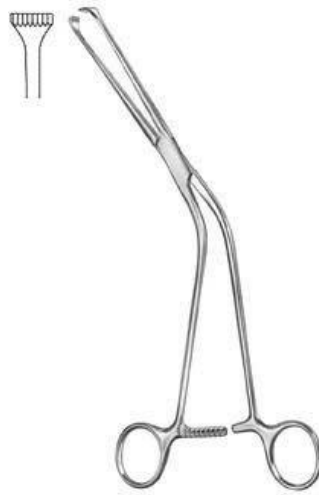

Millin
AI-19-120-23
Capsule Forceps
22 cm,

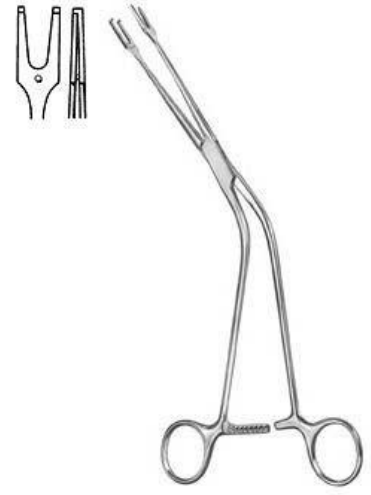

Millin
AI-19-121-24
Ligature Carrying Forceps
24.5 cm,



Millin
AI-19-122-00
Bladder Neck Spreader
29,



Thomson-Walker
AI-19-123-00
Bladder Retractor



Judd-Masson
AI-19-124-00
Bladder Retractor



Millin
AI-19-125-00 A
Bladder Retractor



Legueu
AI-19-126-27
Bladder Spatula
24 cm 35 mm,

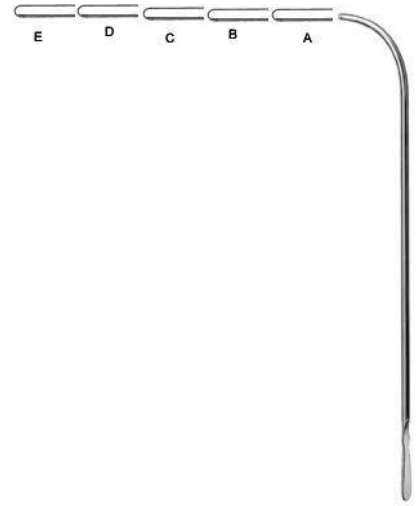

Van Buren
AI-19-127-00 A
Urethral Sound
27.5 cm,

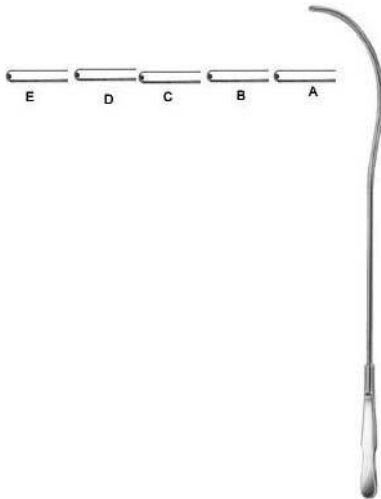

Guyon
AI-19-128-10 A
Urethral Sound
26 cm,



Foreign body forceps
AI-19-129-11
Foreign body forceps
20 cm, 28 cm,



Cusco
AI-20-101
Vaginal Speculum
75 x 32 mm, 85 x 35 mm,



Cusco
AI-20-102-01
Vaginal Speculum
75 x 18 mm,



Cusco
AI-20-103-01
Vaginal Speculum
80 x 22 mm, 100 x 25 mm, 105 x 27 mm,



Cusco
AI-20-104-01
Vaginal Speculum
75 x 34 mm, 85 x 37 mm,



Collin
AI-20-105-01
Vaginal Speculum
85 x 30 mm, 100 x 35 mm,



Pederson
AI-20-106-01
Vaginal Speculum
75 x 13 mm, 100 x 22 mm,



Grave

AI-20-107-01

Vaginal Speculum
75 x 20 mm, 95 x 35 mm,



Semm

AI-20-108-01

Vaginal Speculum
100 x 20 mm, 105 x 27 mm,



Sims

AI-20-109-01

Vaginal Speculum
65 x 25 mm, 70 x 30 mm,



Kristeller

AI-20-110-01

Vaginal Speculum
70 x 27 mm,



Kristeller

AI-20-111-01

Vaginal Retractor
75 x 23 mm,



Kristeller

AI-20-112-01

Vaginal Speculum
Size 1,



Kristeller
AI-20-113-01
Vaginal Speculum
105 x 18 mm,



Kristeller
AI-20-114-01
Vaginal Retractor
110 x 14 mm,



Kristeller
AI-20-115-01
Vaginal Speculum
Size 1,

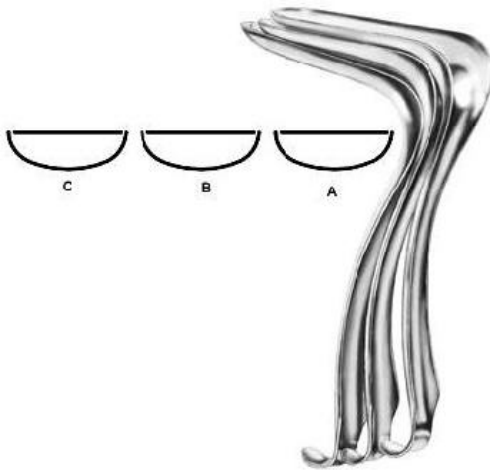

Kristeller
AI-20-116-01
Vaginal Speculum
105 x 26 mm,

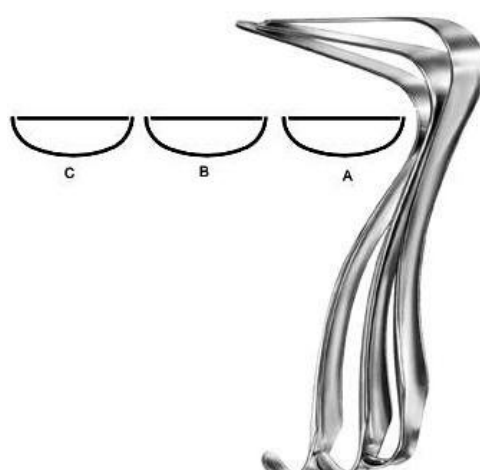

Kristeller
AI-20-117-01
Vaginal Retractor
115 x 22 mm, 115 x 24 mm,



Kristeller
AI-20-118-01
Vaginal Speculum
Size 1,

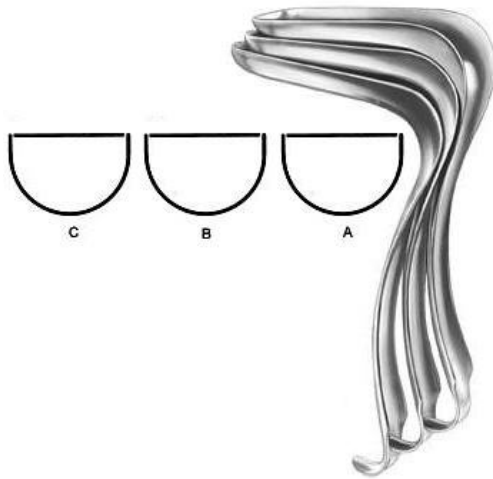

Kristeller
AI-20-119-01
Vaginal Speculum
110 x 27 mm,

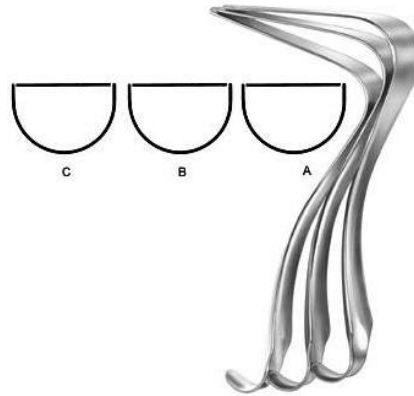

Kristeller
AI-20-120-01
Vaginal Retractor
115 x 23 mm,



Kallmorgen
AI-20-121-01
Vaginal Speculum



Kallmorgen
AI-20-122-01
Vaginal Retractor
70 x 40 mm Fig. 1, 90 x 40 mm Fig. 2,



Kallmorgen
AI-20-123-01
Vaginal Speculum
70 x 33 mm, 90 x 33 mm,

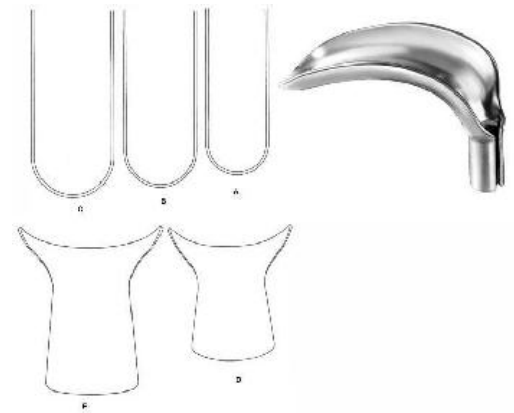

Scherbak
AI-20-125-00
Vaginal Speculum
Size 1,



Auvard
AI-20-126-22
Vaginal Speculum
80 x 43 mm,



Weissbarth
AI-20-127-24
Vaginal Speculum
21 cm 80 x 42 mm,



Breisky
AI-20-128-20
Vaginal Speculum
29 cm 100 x 20 mm, 29 cm 100 x 25 mm,



Kogan
AI-20-129-24
Endocervical Speculum
25 cm 70 x 30 mm,



Kogan
AI-20-130-24
Endocervical Speculum
24.5 cm,



Hegar
AI-20-131-24
Uterine Dilator
18.5 cm 1,0,



Hegar
AI-20-132-02
Uterine Dilator
20 cm 1,0,



Hank
AI-20-133-10
Uterine Dilator
26.5 cm Fig. 9/10,



Sims
AI-20-134-32
Uterine Sound
33 cm,



Valleix
AI-20-135-25
Uterine Sound
29.5 cm,



Braun
AI-20-136-26
Uterine Depressor
27.5 cm,



Schroder
AI-20-137-25
Uterine Tenaculum Forceps
25.5 cm,



Braun
AI-20-138-25
Uterine Tenaculum Forceps
26 cm,



Duplay
AI-20-139-28
Uterine Tenaculum Forceps
25.5 cm,



Beacham
AI-20-140-26
Amniotome
26 cm,



Skene
AI-20-141-24
Uterine Tenaculum Forceps
24 cm,

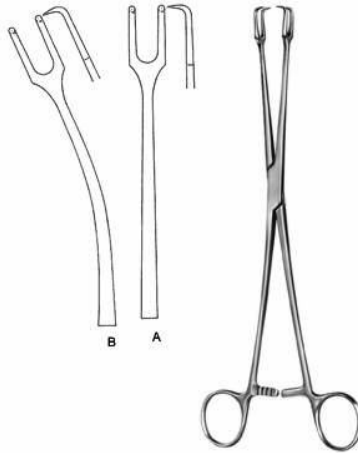

Schroder
IN-20-142-24
Uterine Tenaculum Forceps
25 cm,



Teale
AI-20-143-23
Uterine Tenaculum Forceps
23.5 cm,

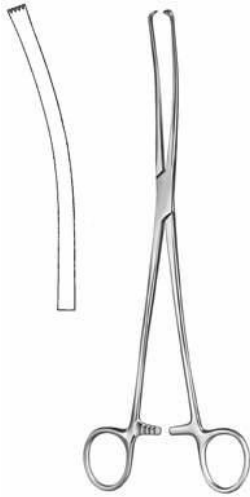

Iowa

AI-20-144-26

Uterine Tenaculum Forceps
26 cm,

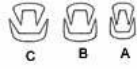

Museux

AI-20-145-24

Uterine Tenaculum Forceps
24 cm,



Jacobs

AI-20-146-21

Uterine Tenaculum Forceps
21 cm,

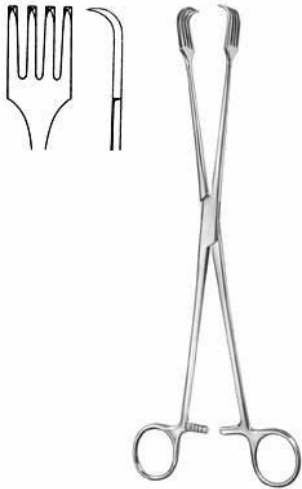

AI-20-147-26

Uterine Tenaculum Forceps
26.5 cm,



Braun

AI-20-148-16

Uterine Tenaculum Forceps
16 cm,

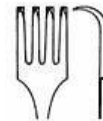

Czerny

AI-20-149-21

Uterine Tenaculum Forceps
21 cm,

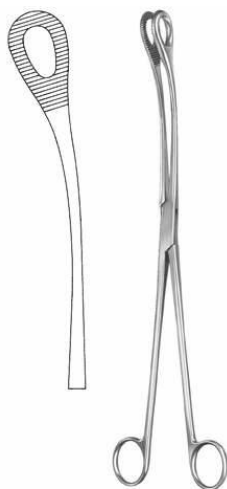

Kelly

AI-20-150-32

Uterine Polypus Forceps
32 cm,



Noto

AI-20-151-27

Uterine Polypus Forceps
27 cm,

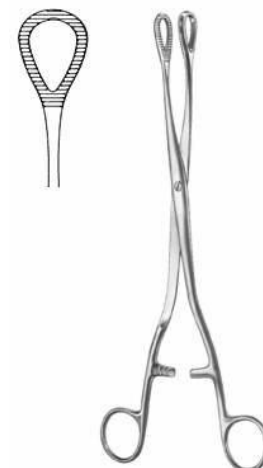

Heywood-Smith

AI-20-152-25

Uterine Polypus Forceps
25 cm,



Doyen

AI-20-153-17

Myoma Screw
17 cm,



Doyen

AI-20-154-17

Myoma Screw
14.5 cm,



Segond

AI-20-155-27

Myoma Knife
28 cm,

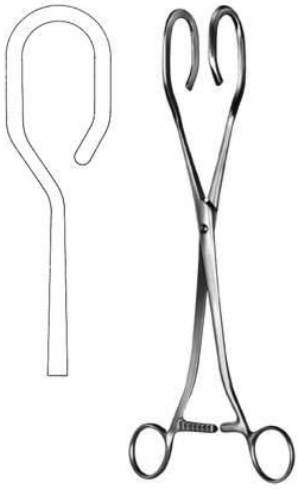

Dartigues

AI-20-156-27

Uterine Seizing Forceps
28 cm,

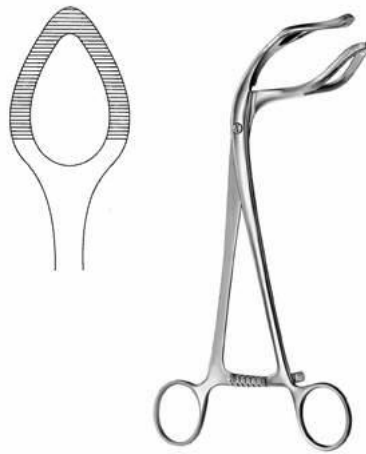

Somer

AI-20-157-27

Uterine Seizing Forceps
22.5 cm,



Collin

AI-20-158-25

Uterine Seizing Forceps jaw 40 mm wide
26 cm,



Ayre

AI-20-159-23

Conization Knife cutting edge 3,6 mm wide
23.5 cm,



Emmett

AI-20-160-03

Fistula Hook
22 cm Fig.3,



Simon

AI-20-161-22

Fistula Hook
21.5 cm,



Simon
AI-20-162-22
Fistula Hook
21.5 cm,



Novak
AI-20-163-23
Suction Curette 4 mm ?
24.5 cm,



Kevorkian
AI-20-164-23
Uterine Biopsy Curette 6,0 mm ?
30 cm,



Munchen
AI-20-165-27
Uterine Biopsy Curette 4,8 mm ?
27 cm,



Gellhorn
AI-20-166-23
Uterine Biopsy Forceps jaw 8,6 mm wide
24 cm,



Faure
AI-20-167-21
Faure Uterine Biopsy Forceps
21 cm,

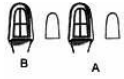

Schubert

AI-20-168-21

Uterine Biopsy Forceps jaw 4,8 mm wide
21.5 cm, 28 cm,

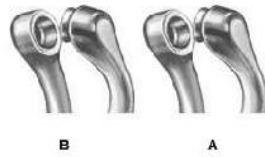

Thoms-Gaylor

AI-20-169-22

Uterine Biopsy Forceps jaw 5,6 mm ?
21 cm, 23.5 cm,

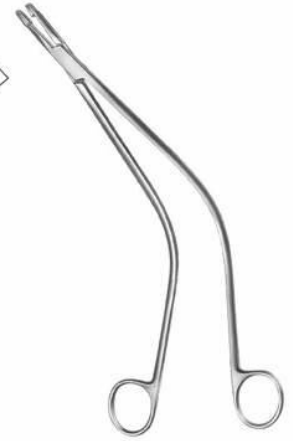

Schubert

AI-20-170-26

Schubert Uterine Biopsy Forceps
25.5 cm,

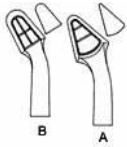

Van Doren

AI-20-171-24

Uterine Biopsy Forceps jaw 4,9 mm wide
27 cm, 25.5 cm,



Alexander

AI-20-172-28

Uterine Biopsy Forceps jaw 5,1 mm wide
28 cm,



Kevorkian

AI-20-173-32

Uterine Biopsy Forceps
25 cm,

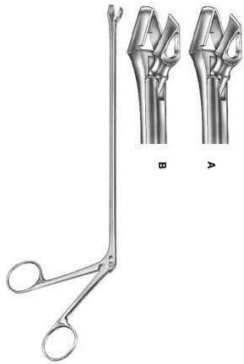

Schumacher
AI-20-174-01

Uterine Biopsy Forceps jaw 4,6 / 5,4 mm wide
24 cm,



Schumacher
AI-20-175-00

Uterine Biopsy Forceps
25 cm,



AI-20-176-22

IUP Grasping Forceps 3 mm ?
22 cm,

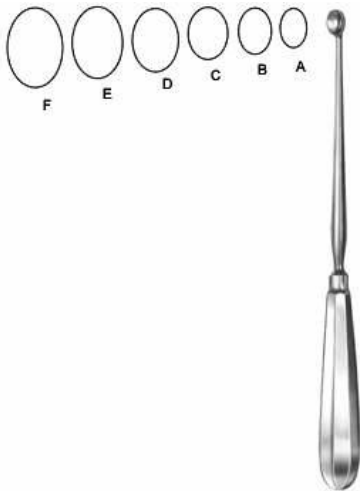

Simon

AI-20-177-01

Uterine Scoop

24.5 cm 9,8 x 8,6 mm, 24.5 cm 11,6 x 8,3 mm,



Simon

AI-20-178-01

Uterine Scoop

30 cm 9,8 x 8,6 mm, 30 cm 11,6 x 8,3 mm,



Recamier

AI-20-179-05

Uterine Curette

31 cm Fig. 00 5 mm, 31 cm Fig. 0 6 mm,



Recamier

AI-20-180-05

Uterine Curette

31 cm Fig. 00 5 mm, 31 cm Fig. 0 6 mm,



Sims

AI-20-181-05

Uterine Curette

31 cm Fig. 00 5 mm, 31 cm Fig. 0 6 mm,

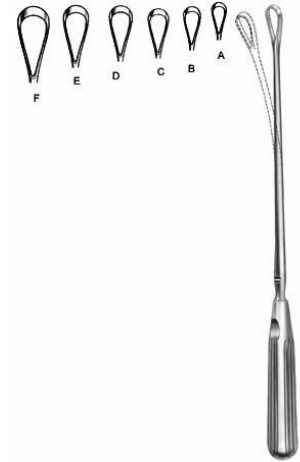

Sims

AI-20-182-05

Uterine Curette

31 cm Fig. 00 5 mm, 31 cm Fig. 0 6 mm,

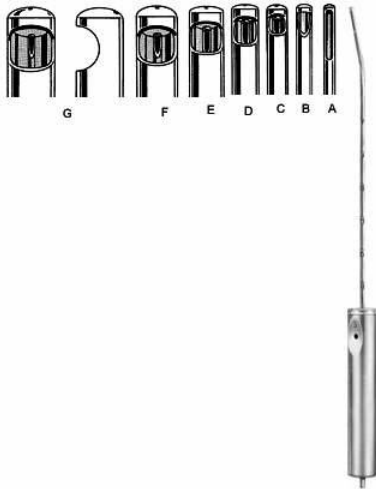

AI-20-183-03

Suction Curette

29 cm 3,0 mm ?, 29 cm 4,5 mm ?, 29 cm 6,0 mm ?,



Douay

AI-20-184-01

Douay

20 cm, 25 cm, 30 cm, 35 cm, 40 cm,



Thomas-Gaylor

AI-20-184-02

Thomas-Gaylor

22 cm, 24 cm,

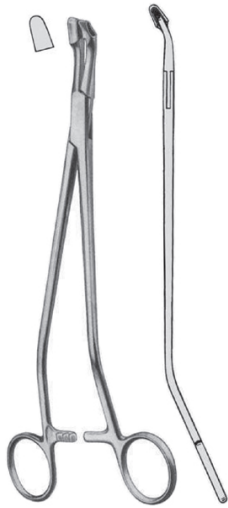

Van Doren
AI-20-184-03
Van Doren
24 cm,



Schumacher-Van Doren
AI-20-184-04
Schumacher-Van Doren
24 cm/6mm 4mm,



Gellhorn
AI-20-184-05
Gellhorn
23 cm,



Schubert
AI-20-184-06
Schubert
21 cm, 28 cm,



Schubert
AI-20-184-07
Schubert
26 cm,

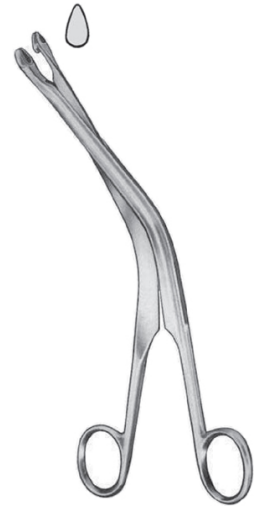

Faure
AI-20-184-08
Faure
21 cm, 24 cm,



ALEXANDER
AI-20-184-09
ALEXANDER
20 cm, 28 cm,



TISCHLER
AI-20-184-10
TISCHLER
23 cm,



TISCHLER-MINI
AI-20-184-11
TISCHLER-MINI
23 cm,



KEVORKIAN-PACIFIC
AI-20-184-12
KEVORKIAN-PACIFIC
23 cm,



TISCHLER (Baggish)
AI-20-184-13
TISCHLER (Baggish)
23 cm,

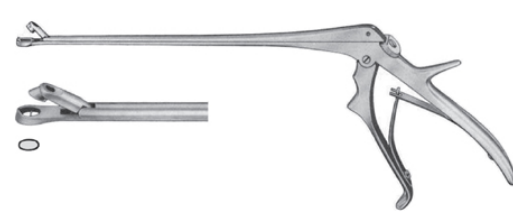

TISCHLER-BURKE
AI-20-184-14
TISCHLER-BURKE
23 cm,

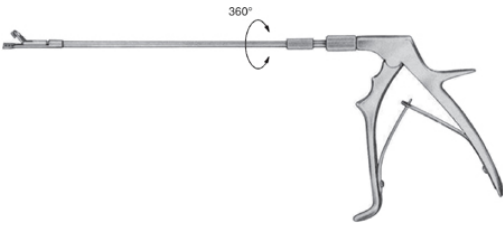

TOWNSEND
AI-20-184-15
Handle only
straight
curved up
curved down

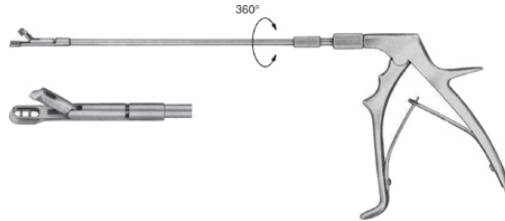

TOWNSEND-TISCHLER
AI-20-184-16
complete
tip only
360°

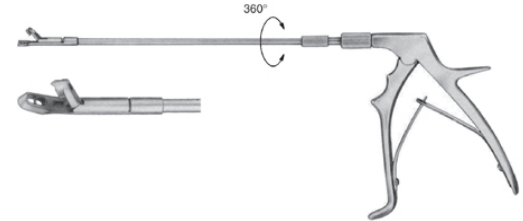

TOWNSEND-TISCHLER
AI-20-184-17
complete
tip only
360°

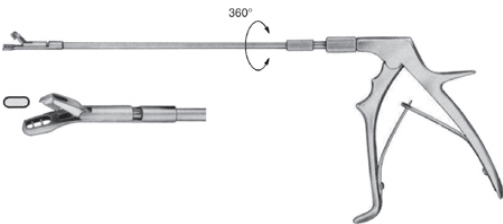

TOWNSEND-TISCHLER
AI-20-184-18
complete
tip only
360°

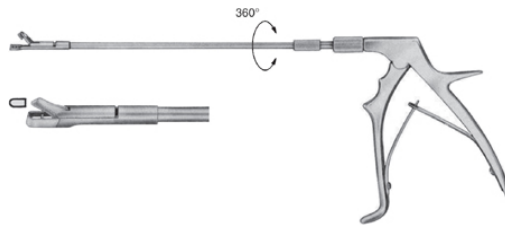

TOWNSEND-MINI
AI-20-184-19
complete
tip only
360°

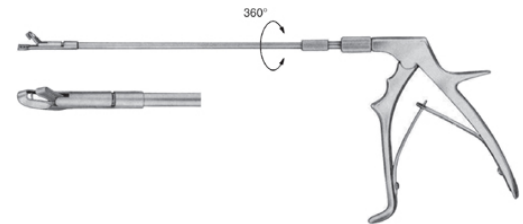

TOWNSEND-MINI
AI-20-184-20
complete
tip only
360°

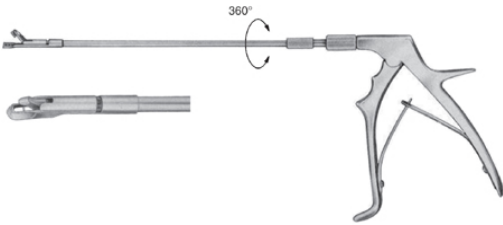

TOWNSEND-MINI
AI-20-184-21
complete
tip only
360°,

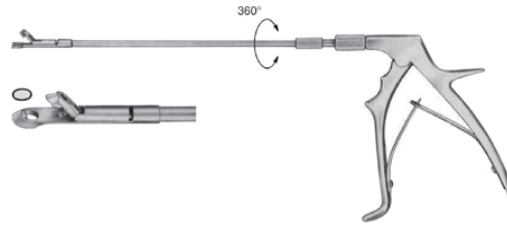

TOWNSEND-BURKE
AI-20-184-22
complete
tip only
360°,

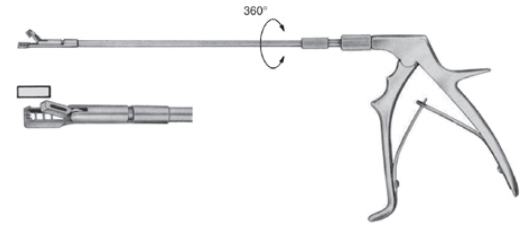

TOWNSEND-KEVORKIAN
AI-20-184-23
complete
tip only
360°,

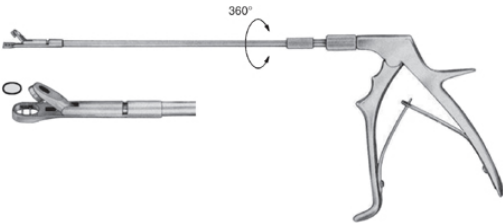

TOWNSEND-KRAUSE
AI-20-184-24
complete
tip only
360°,



EPPENDORF
AI-20-184-25
EPPENDORF
20 cm, 23 cm,



WITTNER
AI-20-184-26
straight
curved
23 cm,



SCHUMACHER
AI-20-184-27
SCHUMACHER
24 cm,



SCHUMACHER
AI-20-184-28
SCHUMACHER
24 cm,



SCHUMACHER
AI-20-184-29
xtension canula 20 cm
tip only
Handle only
24 cm #1,



KEVORKIAAN
AI-20-184-30
KEVORKIAAN
25 cm,



BERGER
AI-20-184-31
BERGER
19 cm / 3mm, 19 cm / 5mm,



Martin

AI-21-101-34

Pelvimeter cm, inch scale
34 cm,



Nagele

AI-5-102-36

Obstetrical Forceps
35 cm,40.5 cm,



Simpson

AI-5-103-30

Obstetrical Forceps
31 cm,



Wrigley

AI-5-104-28

Obstetrical Forceps
28 cm,



Simpson

AI-21-105-36

Obstetrical Forceps
36.5 cm,



Kielland

AI-21-106-41

Obstetrical Forceps
42 cm,

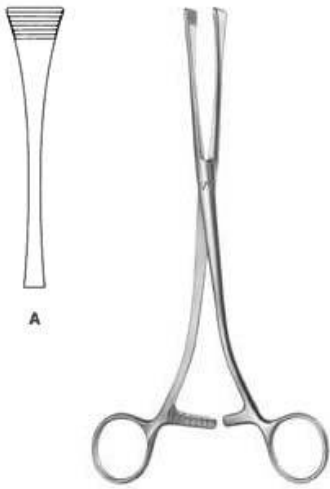

Green-Armytage
AI-21-107-21
Uterine Clamp
21 cm,



Sellheim
AI-21-108-28
Obstetrical Lever
32 cm,

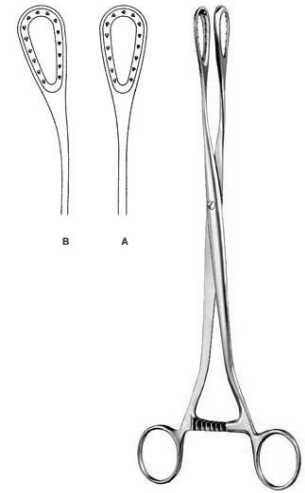

Sanger
AI-21-109-27
Placenta and Ovum Forceps
27.5 cm, 27 cm,

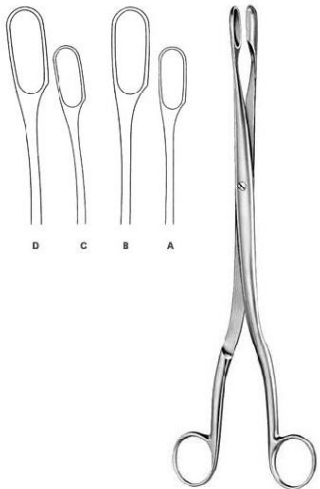

Winter
AI-21-110-01
Placenta and Ovum Forceps
28 cm Fig. 1, 28 cm Fig. 2,

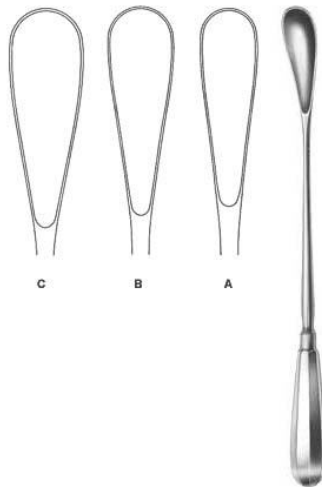

Cuzzi
AI-21-111-01
Placenta Scoop
30 cm 14,5 mm, 30 cm 18 mm,

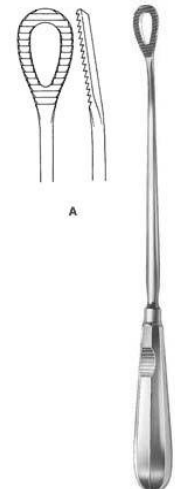

Pestalozza
AI-21-112-30
Placenta Scoop
30 cm,

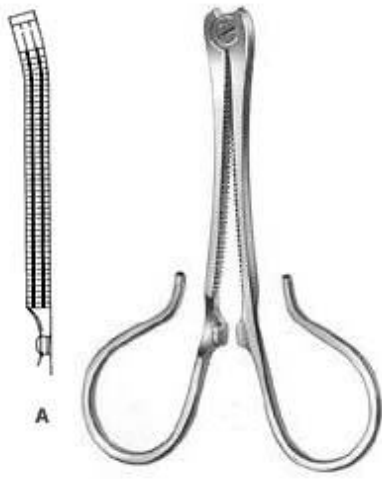

Kane
AI-21-113-08
Umbilical Cord Clamp
8.5 cm,



Collin
AI-21-114-09
Umbilical Cord Clamp
8.5 cm,



Irrigator
AI-23-101-10
Size 1,



Round Bowl
AI-23-102-16
220 mm x 70 mm, 400 mm x 150 mm,



AI-23-103-33
Round Bowl
? x h 6,00 l,



Flat Dish
AI-23-104-11
? x h 0,20 l,



Lid only
AI-23-105-11
Size 1,



Stainless Steel
AI-23-106-04
? x h 0,30 l,



Round Dish
AI-23-107-11

? x h 0,30 l, ? 128 x 38 mm 0,40 l,



Flat Dish
AI-23-108-11

? x h 0,15 l,



Measurer
AI-23-109-01
graduated inside
100cc = 0,1 l,



Measurer
AI-23-110-02
Graduated Inside
0,25 l, 0,50 l,



Petri Dish
AI-23-111-10
with Lid ? x h



Petri Dish
AI-23-112-09
without lid ? x h
Size 1,



Lid for Petri Dishes
AI-23-113-10
Size 1,



Universal Tray
AI-23-114-23
l x b x h,



Instrument Tray
AI-23-115-21
l x b x h,



Universal Tray
AI-23-116-23
l x b x h,



Round Bowl
AI-23-117-22
? x h,



Metal Jar
AI-23-118-30
? 30mm x 90 mm, ? 50mm x 100 mm,



Instrument Box
AI-23-119-16
lid with knob
l x b x h,



Instrument Box
AI-23-120-16
lid with knob
l x b x h,



Instrument Box
AI-23-121-20
l x b x h,



Round Metal Box
AI-23-122-06
? 75 mm x 75 mm, ? 100 mm x 60 mm,



Medicine Cup Graduated Inside
AI-23-123-25
25 ccm,



Medicine Cup Graduated Inside
AI-23-124-50
50 ccm,



Tablet Tray
AI-23-125-75
? 75 mm x 12 mm,



Metal Cup
AI-23-126-90
? 90 mm x 90 mm,



Denture Cup
AI-23-127-75
? 75 mm x 50 mm,



Insert for Cup
AI-23-128-75
? 73 mm x 75 mm,



Kidney Dish
AI-23-129-17
l x b x h,



Placenta Pan
AI-23-130-36
Size 1,



Waste Cotton Collector
AI-23-131-01
? 50 mm x 75 mm,



Spirit Lamp
AI-23-132-07
120 ccm,



Charrière
AI-7-102-35
Amputation Saw
35 cm,



Langenbeck
AI-7-103-23
Amputation Saw
24.5 cm,



Charrière
AI-7-104-27
Amputation Saw
26.5 cm,



AI-7-105-14
Reamer
13.5 cm,



Perthes
AI-7-106-18
Reamer
18 cm,



Perthes
AI-7-107-21
Reamer
21.5 cm,



AI-7-108-14
Reamer
14 cm,



AI-7-111-18
Flat Trephine

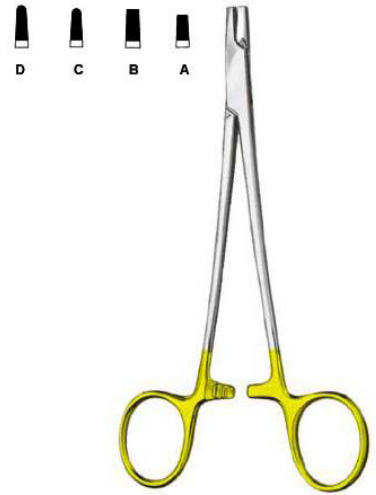

AI-7-112-01
Wire Twisting Forceps
15.5 cm, 18 cm, 20 cm,

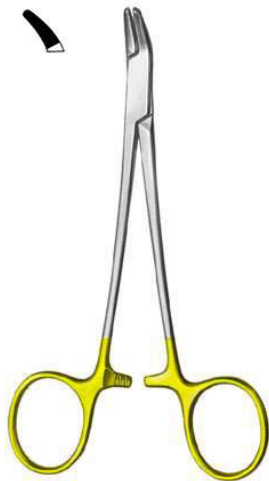

AI-7-113-15
Wire Twisting Forceps
15.5 cm,



AI-7-114-17
Flat Nose Plier
18.5 cm,



AI-7-115-18
Wire Twisting Forceps
19 cm,



AI-7-116-15
Combi-Flat Nose Plier
15 cm,



AI-7-117-01
Flat Nose Plier
18 cm,

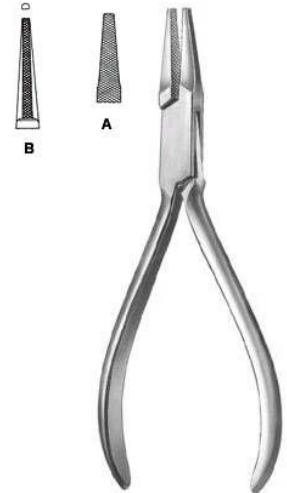

AI-7-118-14
Flat Nose Plier
13.5 cm,



Hackstock
AI-7-119-16
Flat Nose Plier
16 cm,



AI-7-120-01
Flat Nose Plier
17.5 cm,



AI-7-121-18
Wire Cutting Pliers
18.5 cm,



AI-7-122-15
Wire Cutting Pliers
15 cm,



AI-7-123-18
Wire Cutting Pliers
17.5 cm,

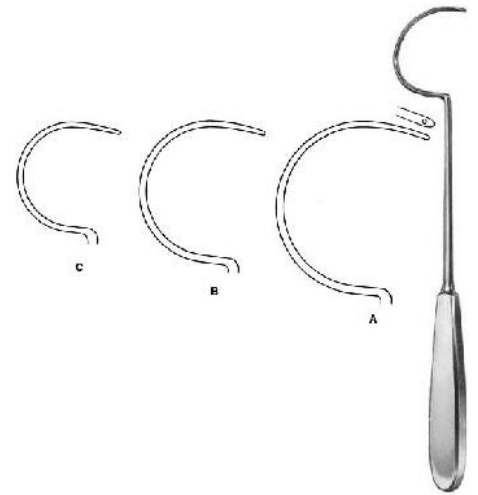

Demel
AI-7-124-18
Wire Guide
31 cm Fig. 1, 29 cm Fig. 2, 28 cm Fig. 3,

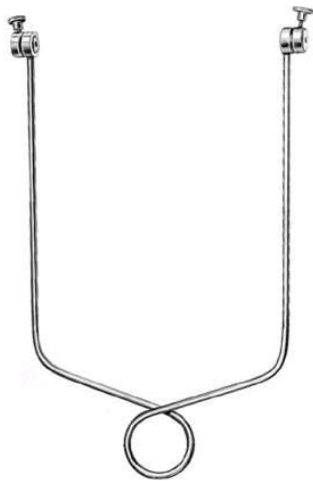

Bohler
AI-7-125-15
Extension Bow



Kirschner
AI-7-126-01
Extension Bow
18.5 cm, 26.5 cm,



AI-7-127-06
Traction Hook for Extension Bows



Kirschner
AI-7-128-06
Wire Drill
6 cm, 12 cm,



Kirschner
AI-7-129-06
Wire Drill
14 cm, 16 cm,



Kirschner
AI-7-130-10
Wire Drill
31 cm,



Kirschner
AI-7-131-10
Wire Drill
6 cm, 12 cm, 18 cm,



Kirschner
AI-7-132-10
Wire Drill
31 cm,



Buckley
AI-7-133-02
Chisel
16 cm,



Buckley
AI-7-134-02
Gouge
16 cm,



Stout
AI-7-135-03
Bone Chisel
21 cm,



AI-7-136-04
Bone Chisel
18 cm,



AI-7-137-04
Bone Chisel
18 cm,



AI-7-138-04
Bone Chisel
17 cm,



AI-7-139-04
Bone Chisel
17 cm,

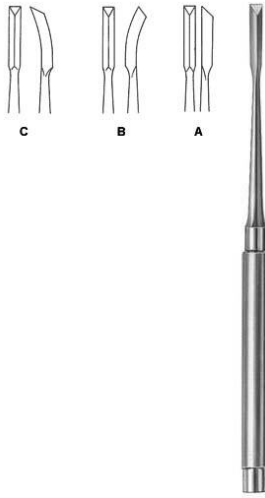

Gardner
AI-7-140-01
Bone Chisel
17 cm 4mm,



Snyder-O.S.U
AI-7-141-03
Bone Chisel
16.5 cm 3mm, 16.5 cm 5.5mm,



O.S.U.
AI-7-142-01
one Chisel
17 cm 7mm,



O.S.U.
AI-7-143-01
one Chisel
17 cm 9mm,



AI-7-144-08
Osteotome
13.5 cm 8mm, 13.5 cm 10mm, 13.5 cm 12mm, 13.5 cm 14mm, 13.5 cm 16mm,

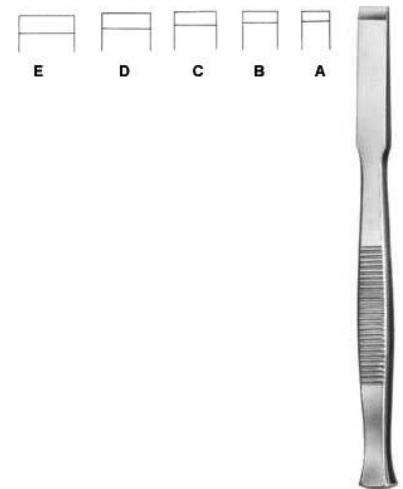

AI-7-145-08
Chisel
13.5 cm 8mm, 13.5 cm 10mm, 13.5 cm 12mm, 13.5 cm 14mm, 13.5 cm 16mm,



AI-7-146-08

Gouge

13.5 cm 8mm, 13.5 cm 10mm, 13.5 cm 12mm, 13.5 cm 14mm, 13.5 cm 16mm,



Partsch

AI-7-147-02

Chisel

13.5 cm 2mm, 13.5 cm 3mm, 13.5 cm 4mm, 13.5 cm 5mm, 13.5 cm 6mm, 17 cm 2mm, 17 cm 3mm, 17 cm 4mm, 17 cm 5mm, 17 cm 6mm,



Partsch

AI-7-148-02

Gouge

13.5 cm 2mm, 13.5 cm 3mm, 17 cm 2mm, 17 cm 3mm,



Stille

AI-7-149-10

Chisel

20 cm 10mm, 20 cm 15mm, 20 cm 20mm, 20 cm 25mm,



Stille

AI-7-150-10

Osteotome

20 cm 10mm, 20 cm 15mm, 20 cm 20mm, 20 cm 25mm,



Stille

AI-7-151-10

Gouges

20 cm 10mm, 20 cm 15mm, 20 cm 20mm, 20 cm 25mm,



Lambotte, Mini

AI-7-152-02

Osteotome

12.5 cm 2mm, 12.5 cm 3mm, 12.5 cm 4mm, 12.5 cm 6mm, 12.5 cm 8mm,



Lambotte

AI-7-153-15

Osteotome

24 cm 15mm, 24 cm 20mm, 24 cm 25mm, 24 cm 30mm,



Lambotte

AI-7-154-15

Osteotome

24 cm 15mm, 24 cm 20mm, 24 cm 25mm, 24 cm 30mm,



Smith-Petersen

AI-7-155-06

Osteotome

20.5 cm 6mm, 20.5 cm 9mm, 20.5 cm 13mm,



Smith-Petersen

AI-7-156-06

Osteotome

20.5 cm 6mm, 20.5 cm 9mm, 20.5 cm 13mm, 20.5 cm 16mm, 20.5 cm 19mm,



Smith-Petersen

AI-7-157-09

Gouge

20.5 cm 9mm, 20.5 cm 14mm, 20.5 cm 19mm, 20.5 cm 25mm,



Smith-Petersen
AI-7-158-09

Gouge

20.5 cm 9mm, 20.5 cm 14mm, 20.5 cm 19mm,



Hoke
AI-7-159-03

Osteotome

17 cm 3mm, 17 cm 5mm, 17 cm 6mm, 17 cm 8mm,

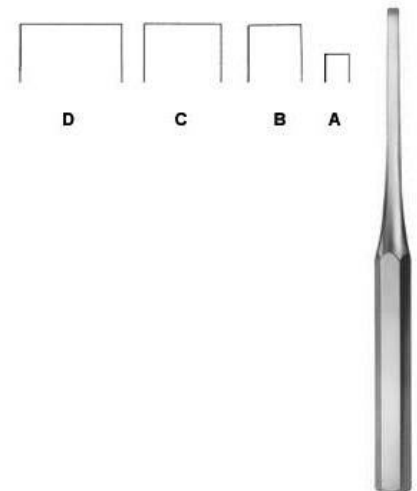

Hibbs

AI-7-160-06

Osteotome

24.5 cm 6mm, 24.5 cm 13mm, 24.5 cm 19mm,

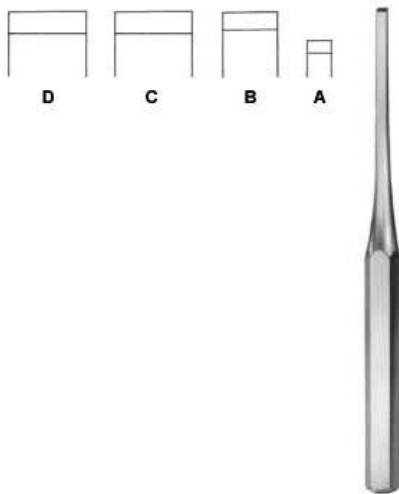

Hibbs
AI-7-161-06

Chisel

24.5 cm 6mm, 24.5 cm 19mm, 24.5 cm 13mm,

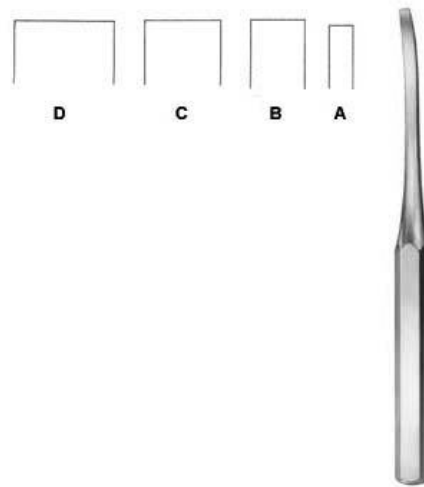

Hibbs
AI-7-162-06

Osteotome

24.5 cm 6mm, 24.5 cm 13mm, 24.5 cm 19mm,

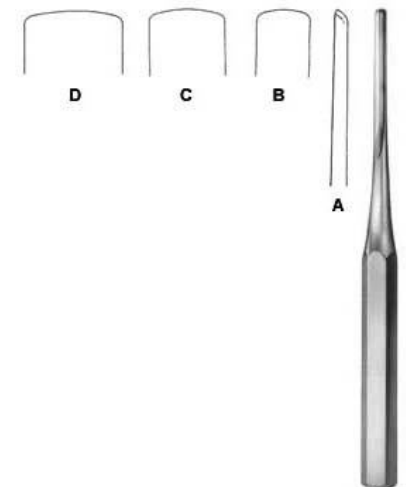

Hibbs
AI-7-163-06

Hibbs

24.5 cm 6mm, 24.5 cm 13mm, 24.5 cm 19mm,



Hibbs
AI-7-164-06

Gouge

24.5 cm 6mm, 24.5 cm 13mm, 24.5 cm 19mm,

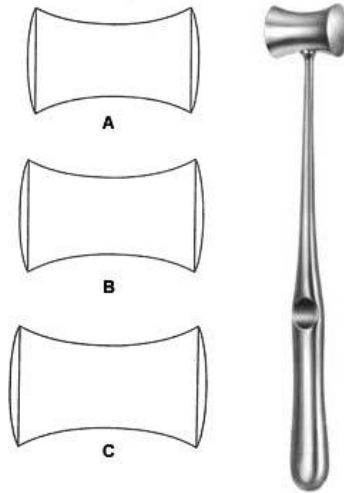

Williger
AI-7-165-01

Mallet

24 cm,

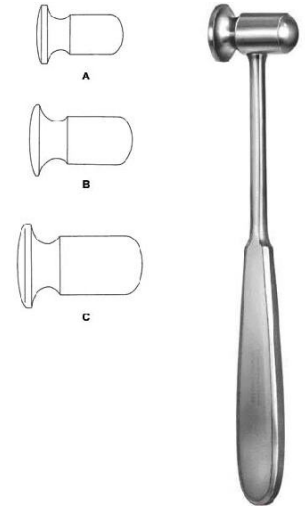

Doyen
AI-7-166-01

Mallet

20.5 cm, 21 cm, 21.5 cm,



Collin
AI-7-167-20

Mallet

20 cm,

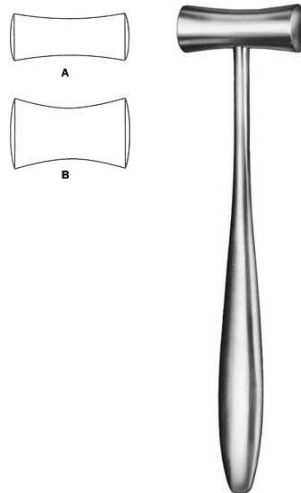

Lucae
AI-7-168-01

Mallet

19.5 cm,



Cottle
AI-7-169-19

Mallet

19 cm,



Williger
AI-7-170-01
Mallet
16.5 cm,



Mead
AI-7-171-17
Mallet
19 cm,



Partsch
AI-7-172-18
Mallet
19 cm,

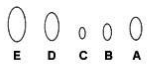

Schede
AI-7-173-01
Bone Curette Fig. 0 to 4
17 cm,

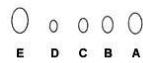

Volkman
AI-7-174-01
Bone Curette
17 cm Fig. 0, 17 cm Fig. 00, 17 cm Fig. 000, 17 cm Fig. 1, 17 cm Fig. 2, 17 cm Fig. 3, 17 cm Fig. 4,



Bruns
AI-7-175-01
Bone Curette
17 cm Fig. 0, 17 cm Fig. 00, 17 cm Fig. 000, 17 cm Fig. 1, 17 cm Fig. 2, 17 cm Fig. 3, 17 cm Fig. 4,

o o o o
D C B A



Spratt

AI-7-176-01

Bone Curette

17 cm Fig. 0, 17 cm Fig. 00, 17 cm Fig. 000, 17 cm Fig. 0000, 17 cm Fig. 1, 17 cm Fig. 2, 17 cm Fig. 3, 17 cm Fig. 4, 17 cm Fig. 5,

o o o
C B A



Bruns

AI-7-177-01

Bone Curette

23 cm Fig. 0, 23 cm Fig. 00, 23 cm Fig. 000, 23 cm Fig. 1, 23 cm Fig. 2, 23 cm Fig. 3,

o o o
C B A



Scoville

AI-7-178-25

Bone Curette

25 cm,

o o o o o
E D C B A



Simon

AI-7-179-01

Bone Curette

25 cm Fig. 1, 25 cm Fig. 2, 25 cm Fig. 3, 25 cm Fig. 4, 25 cm Fig. 5,

o o o o o
E D C B A



Modell USA

AI-7-180-01

Bone Curette

16 cm Fig. 1, 16 cm Fig. 2, 16 cm Fig. 3, 16 cm Fig. 4,

o o o o o
E D C B A



Modell USA

AI-7-181-01

Bone Curette

15.5 cm Fig. 1, 15.5 cm Fig. 2, 15.5 cm Fig. 3, 15.5 cm Fig. 4,



Modell USA
AI-7-182-01

Bone Curette

15.5 cm Fig. 1, 15.5 cm Fig. 2, 15.5 cm Fig. 3, 15.5 cm Fig. 4,



Halle

AI-7-183-01

Bone Curette

21 cm Fig. 1, 21 cm Fig. 2, 21 cm Fig. 3,



Volkman

AI-7-184-01

Bone Curette, double-ended

12.5 cm, 14.5 cm, 17 cm,



Volkman

AI-7-185-13

Bone Curette, double-ended

13 cm, 16 cm,



AI-7-186-21

Bone Curette, double-ended

21 cm,



Williger

AI-7-187-00

Bone Curette, double-ended

13.5 cm Fig. 00/0, 13.5 cm Fig. 0/1, 13.5 cm Fig. 1/2,



Hemingway
AI-7-189-11
Bone Curette, double-ended
18 cm,



Hemingway
AI-7-190-00
Bone Curette, double-ended
18.5 cm,



AI-7-191-01
Bone Curette, double-ended
17.5 cm,

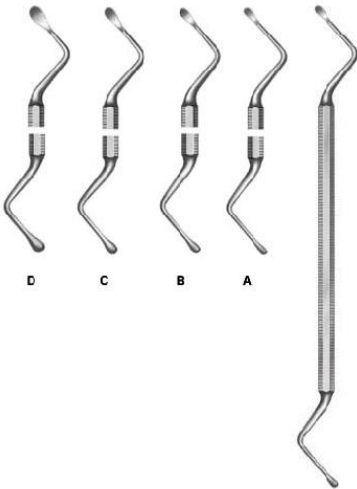

Lucas
AI-7-192-11
Bone Curette, double-ended
18 cm,

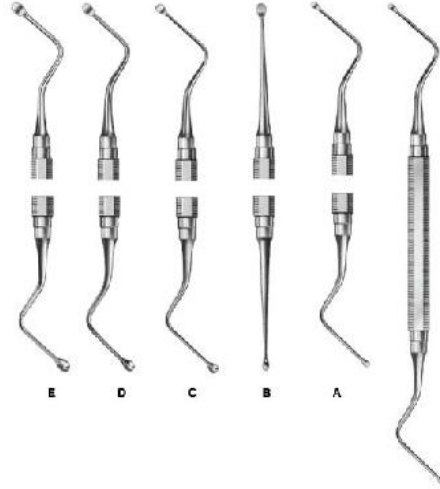

Miller-Colburn
AI-7-193-00
Bone Curette, double-ended
17 cm Fig. 0, 17 cm Fig. 1, 17 cm Fig. 2, 17 cm Fig. 3,

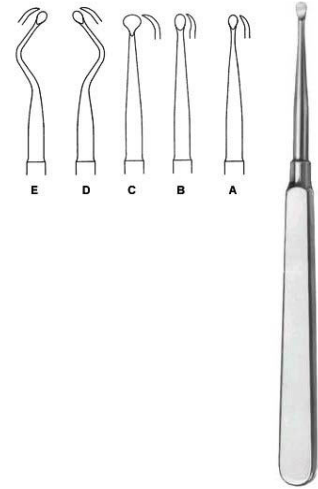

Molt
AI-7-194-01
Bone Curette
17 cm Fig. 1, 17 cm Fig. 2, 17 cm Fig. 3, 17 cm Fig. 4,

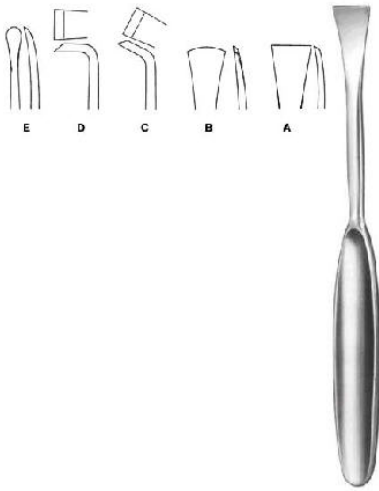

Martin-Langenbeck
AI-7-195-01
Periosteal Elevator
19 cm 16mm,



Langenbeck
AI-7-196-18
Periosteal Elevator
18.5 cm,



Langenbeck
AI-7-197-19
Periosteal Elevator
19.5 cm,



AI-7-198-05
Periosteal Elevator
16 cm 5mm, 16 cm 6mm, 16 cm 7mm,



Sedillot
AI-7-199-21
Periosteal Elevator
22 cm 15mm,



Williger
AI-7-200-13
Periosteal Elevator
12.5 cm 5mm,



Kahre-Williger

AI-7-201-04

Periosteal Elevator
4 mm, 5 mm, 7 mm,

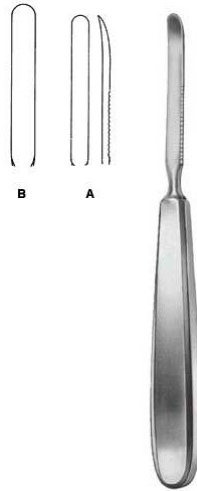

AI-7-202-06

Periosteal Elevator
17 cm 6 mm, 17 cm 8 mm,

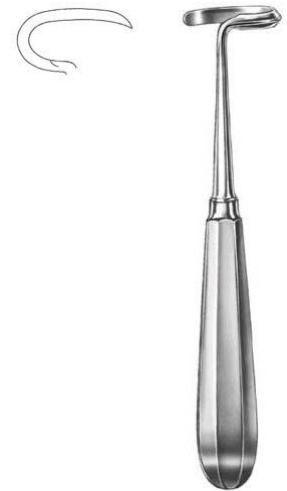

Doyen

AI-7-203-17

Rib Raspatory
17.5 cm,

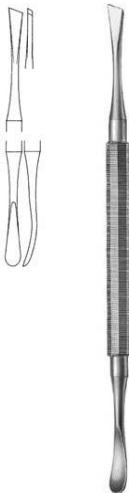

West

AI-7-204-19

Periosteal Elevator, double-ended
18.5 cm,



Ohl

AI-7-205-17

Periosteal Elevator, double-ended
17.5 cm,



Semb

AI-7-206-01

Periosteal Elevator
18.5 cm Fig. 1, 21.5 cm Fig. 2,



AI-7-207-22
Bone File
22 cm,

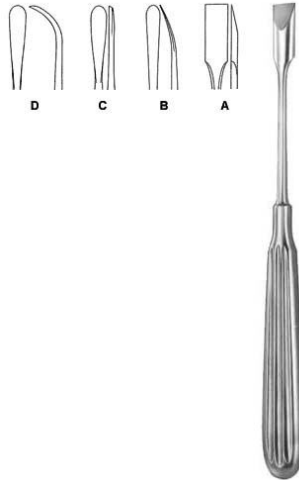

Adson
AI-7-208-17
Elevator
17 cm, 17.5 cm,

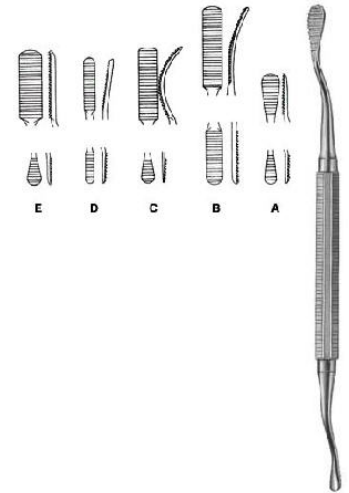

Miller-Colburn
AI-7-209-01
Bone File
18 cm Fig. 1, 18 cm Fig. 2, 18 cm Fig. 3, 18 cm Fig. 4, 18 cm Fig. 5,

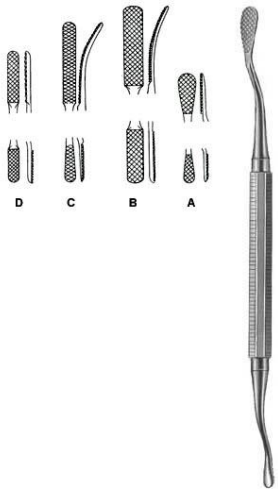

Miller-Colburn
AI-7-210-01
Bone File
18 cm Fig. 1, 18 cm Fig. 2, 18 cm Fig. 3, 18 cm Fig. 4,



Langenbeck
AI-7-211-20
Elevator
19.5 cm 8 mm, 19.5 cm 10 mm,

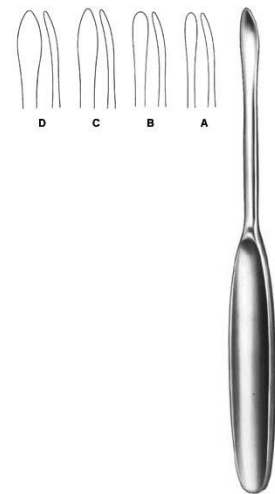

Martin-Langenbeck
AI-7-212-01
Elevator
17 cm 5 mm, 17 cm 7 mm, 17 cm 8 mm,



Vickers
AI-7-213-17
Elevator
17 cm,



Vickers
AI-7-214-17
Dissector
17 cm,



Williger
AI-7-215-17
Elevator
16 cm 5,5 mm,



Williger
AI-7-216-16
Elevator
16 cm 5,5 mm,



Mead
AI-7-217-17
Mallet
19 cm,



AI-7-218-18
Periosteal Elevator



Hohmann
AI-7-219-43
Bone Lever
23.5 cm,



Lempert
AI-7-220-19
Bone Rongeur
19 cm,



Luer
AI-7-221-17
Bone Rongeur
18.5 cm, 18 cm,



Zaufal-Jansen
AI-7-222-18
Bone Rongeur
18 cm,

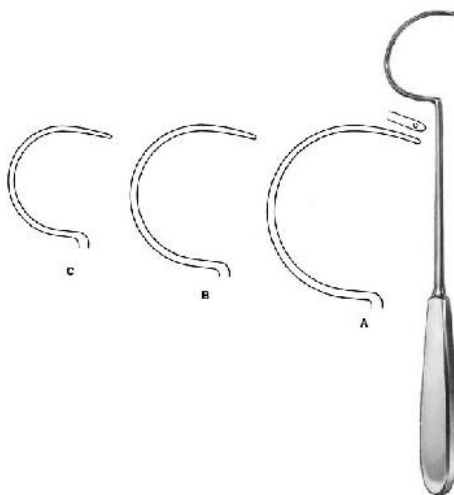

Demel
AI-7-124-01
Wire Guide
31 cm Fig. 1, 29 cm Fig. 2, 28 cm Fig. 3,



CARROL
AI-7-124-02
CARROL
11 cm,



BRAND
AI-7-124-03
BRAND



BRAND
AI-7-124-04
BRAND
15 cm,



BRAND
AI-7-124-05
BRAND
19 cm,



BRAND
AI-7-124-06
BRAND
25 cm,

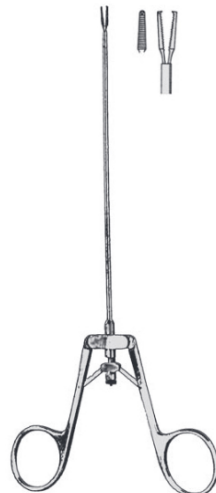

KLEINERT-KUTZ
AI-7-124-07
KLEINERT-KUTZ
20 cm,



ZEMENT
AI-7-124-08
ZEMENT
25 cm / 5x10 mm,



straight
AI-20-185-01
straight



straight
AI-20-185-02
straight



straight
AI-20-185-03
straight



curved up
AI-20-185-04
curved up



curved up
AI-20-185-05
curved up



curved up
AI-20-185-06
curved up



curved to right
AI-20-185-07
curved to right



curved to right
AI-20-185-08
curved to right



curved to left
AI-20-185-09
curved to left



curved to left
AI-20-185-10
curved to left



straight
AI-20-185-11
straight
1,0 mm Ø, 1,5 mm Ø, 2,0 mm Ø, 2,5 mm Ø,



straight
AI-20-185-12
straight



curved up
AI-20-185-13
curved up

1,0 mm Ø, 1,5 mm Ø, 2,0 mm Ø, 2,5 mm Ø,



curved up
AI-20-185-14
curved up



curved to right
AI-20-185-15
curved to right
1,0 mm Ø, 1,5 mm Ø, 2,0 mm Ø, 2,5 mm Ø,



curved to right
AI-20-185-16
curved to right



curved to left
AI-20-185-17
curved to left
1,0 mm Ø, 1,5 mm Ø, 2,0 mm Ø, 2,5 mm Ø,



curved to left
AI-20-185-18
curved to left

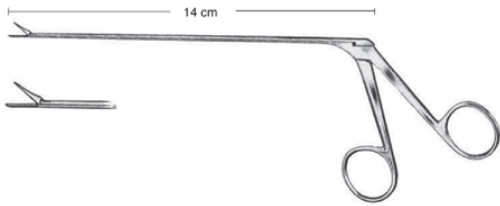

micro-scissors
AI-20-185-19
micro-scissors

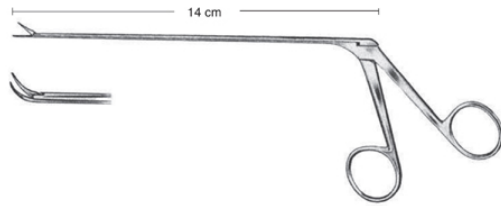

micro-scissors
AI-20-185-20
micro-scissors

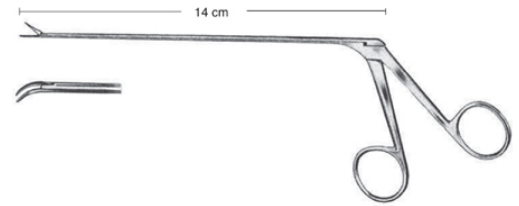

micro-scissors
AI-20-185-21
micro-scissors

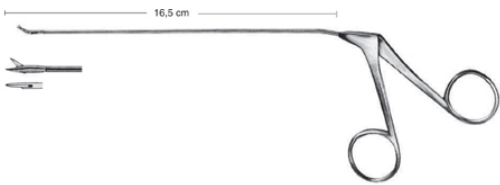

micro-scissors
AI-20-185-22
micro-scissors



micro-scissors
AI-20-185-23
micro-scissors

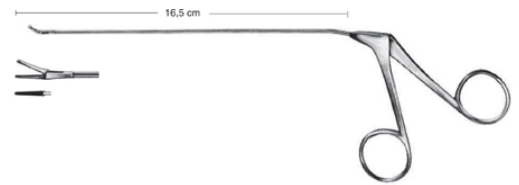

Micro forceps
AI-20-185-24
Micro forceps

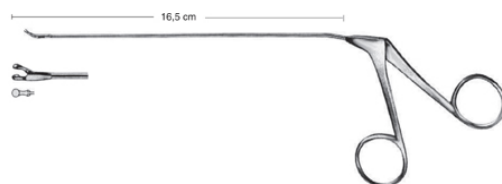

Micro forceps

AI-20-185-25

Micro forceps
2,5 mm,



LITTAUER
AI-20-186-01
LITTAUER
12 cm,

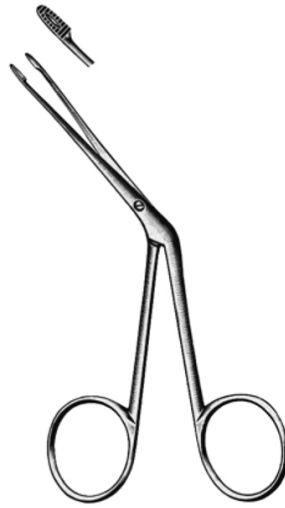

HARTMANN
AI-20-186-02
HARTMANN
12 cm,



HARTMANN
AI-20-186-03
HARTMANN
14 cm,

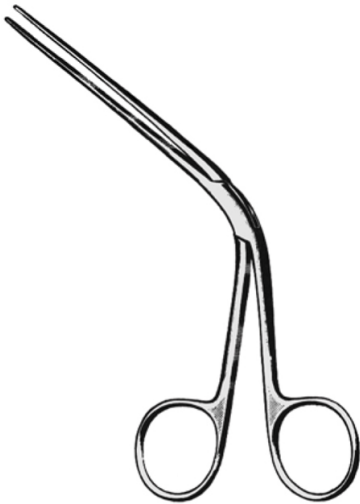

TILLEY
AI-20-186-04
TILLEY
14 cm,



QUIRE
AI-20-186-05
QUIRE
10 cm,

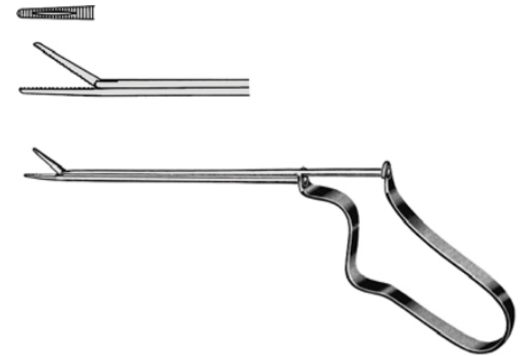

BUCK
AI-20-186-06
BUCK
11 cm,



STRUEMPEL
AI-20-186-07
STRUEMPEL



HARTMANN
AI-20-186-08
HARTMANN
8.5 cm, 14.0 cm, 16.5 cm,



HARTMANN
AI-20-186-09
HARTMANN
8.5 cm 1x2, 14.0 cm 1x2, 16.5 cm 1x2,

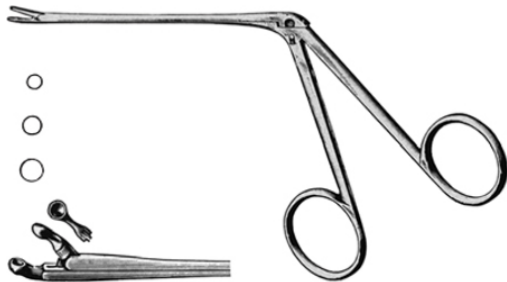

HERZFELD
AI-20-186-10
HERZFELD
8.5 cm, 2.0 mm ø, 2.0 mm ø, 2.5 mm ø, 3.0 mm ø,

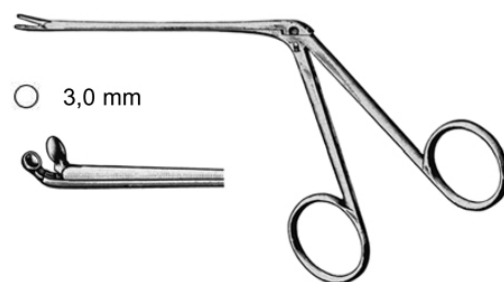

HERZFELD
AI-20-186-11
HERZFELD
8.5 , 3.0 mm Ø,

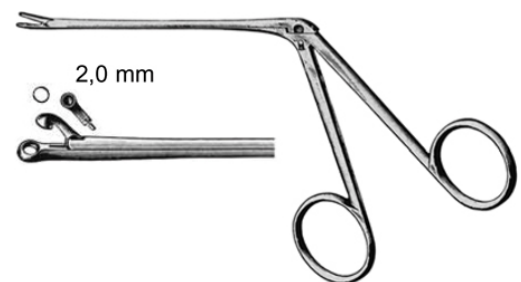

HOFFMANN
AI-20-186-12
HOFFMANN
8,5 cm, 2 mm,

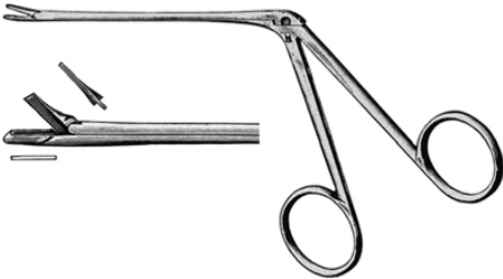

HARTMANN
AI-20-186-13
HARTMANN
8.5 cm,



HARTMANN
AI-20-186-14
HARTMANN
8.5 cm,

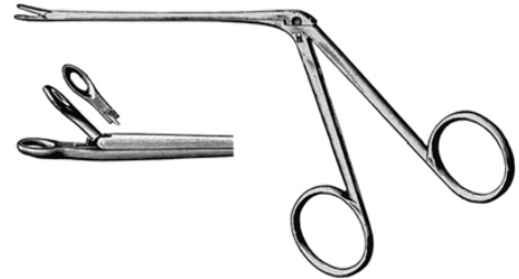

STRUEMPEL
AI-20-186-15
STRUEMPEL
8.5 cm,

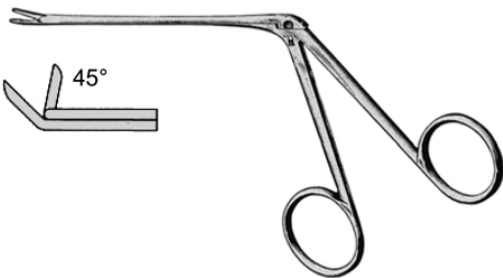

STRUEMPEL
AI-20-186-16
STRUEMPEL
8.5 , 2,5 mm,

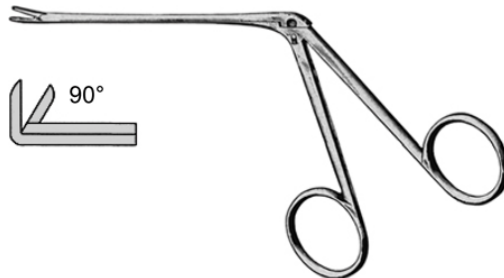

STRUEMPEL
AI-20-186-17
STRUEMPEL
8.5 , 2,5 mm,

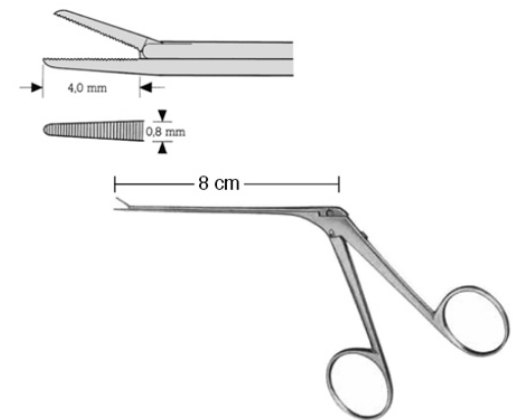

HARTMANN-MIKRO
AI-20-186-18
Curved up
Left
Right
Curved

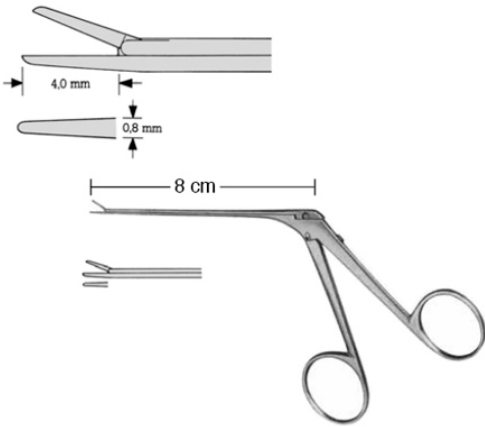

HARTMANN-MIKRO
AI-20-186-19
glatt / smooth / lisse
4x0,8,

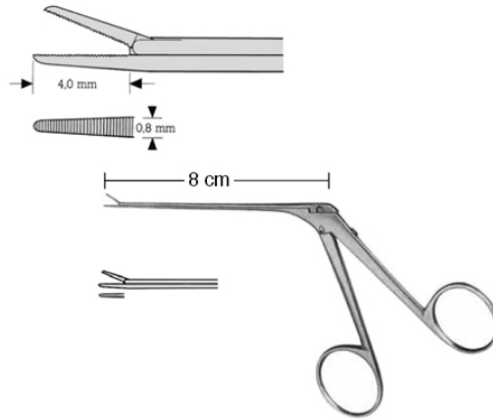

HARTMANN-MIKRO
AI-20-186-20
gezahnt / serrated /
4x0,8,

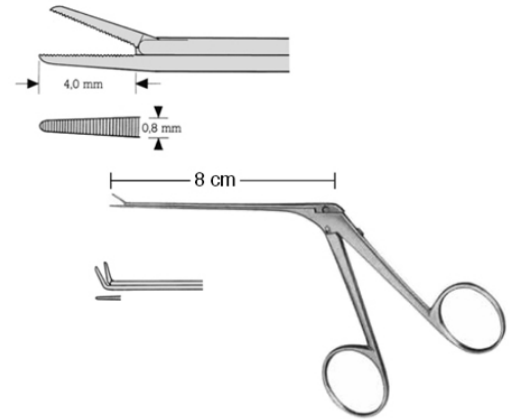

HARTMANN-MIKRO
AI-20-186-21
aufgebogen / curved up
4x0,8,

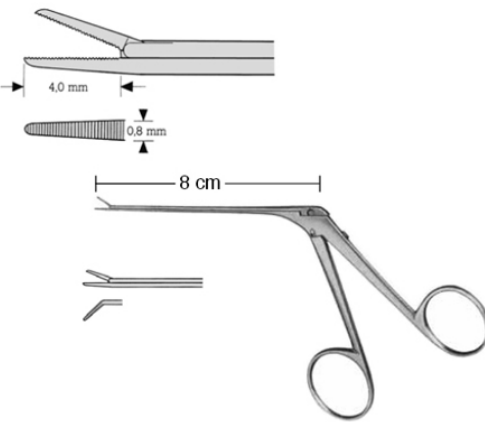

HARTMANN-MIKRO
AI-20-186-22
links / left

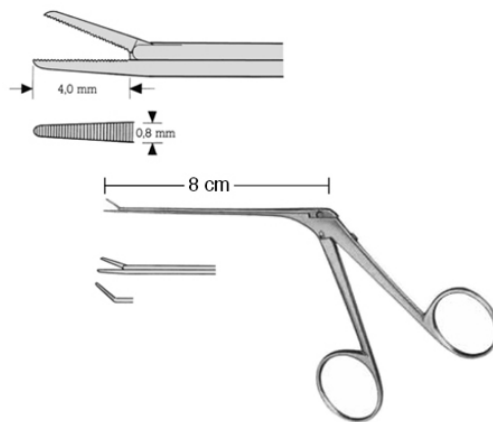

HARTMANN-MIKRO
AI-20-186-23
rechts / right

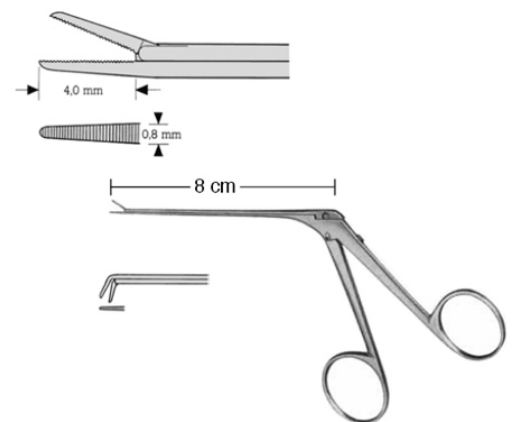

HARTMANN-MIKRO
AI-20-186-24
curved downwards

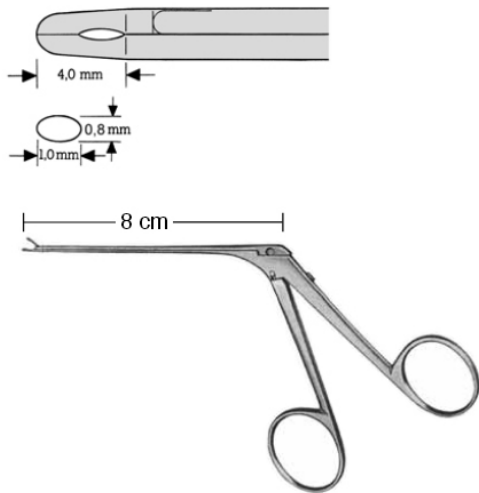

WULLSTEIN
AI-20-186-25
WULLSTEIN

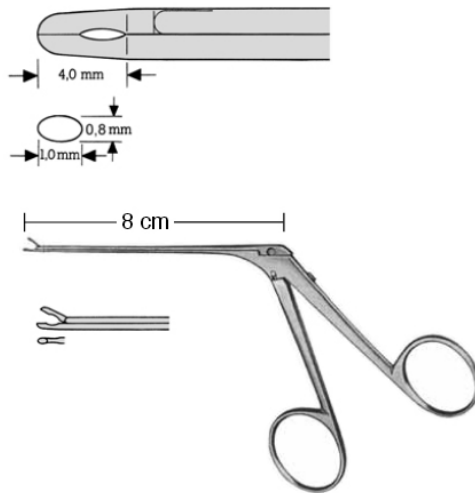

WULLSTEIN
AI-20-186-26
straight

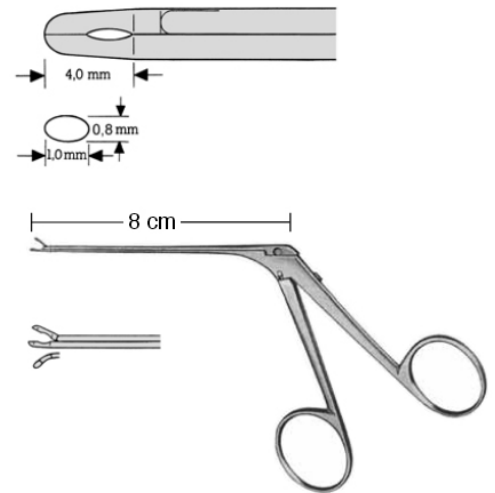

WULLSTEIN
AI-20-186-27
Left

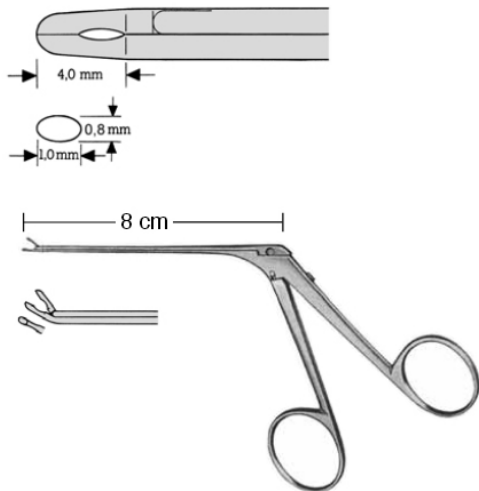

WULLSTEIN
AI-20-186-28
Curved up

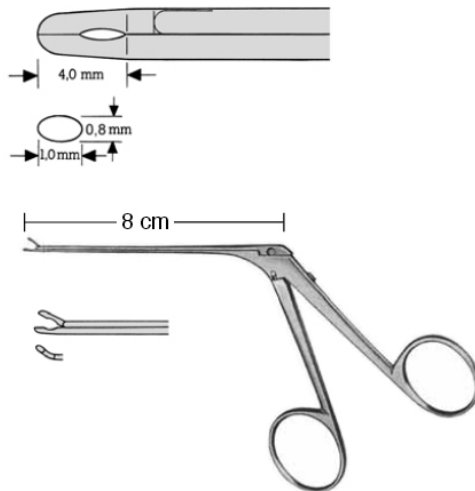

WULLSTEIN
AI-20-186-29
right

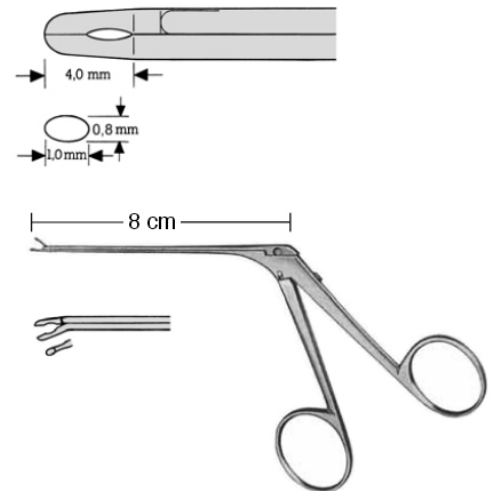

WULLSTEIN
AI-20-186-30
curved downwards

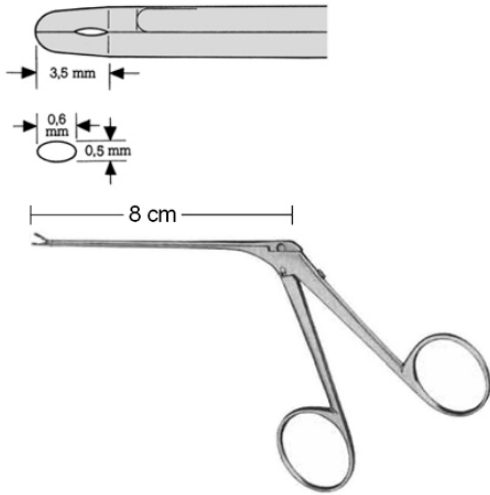

HARTMANN WULLSTEIN
AI-20-186-31
HARTMANN WULLSTEIN

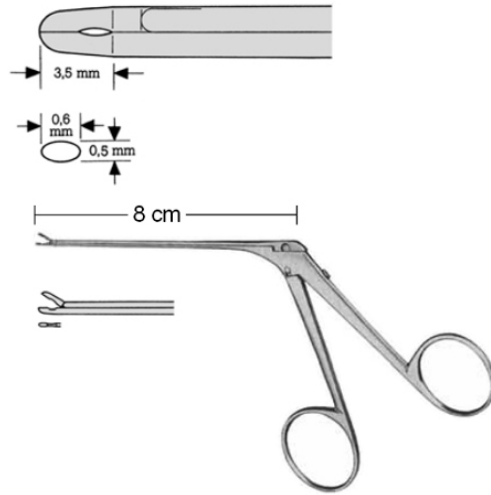

HARTMANN WULLSTEIN
AI-20-186-32
straight

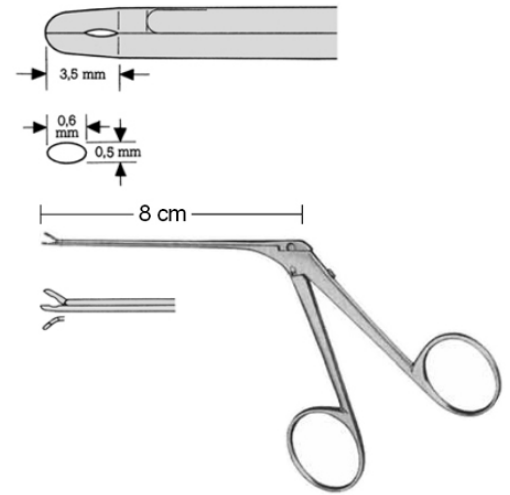

HARTMANN WULLSTEIN
AI-20-186-33
left

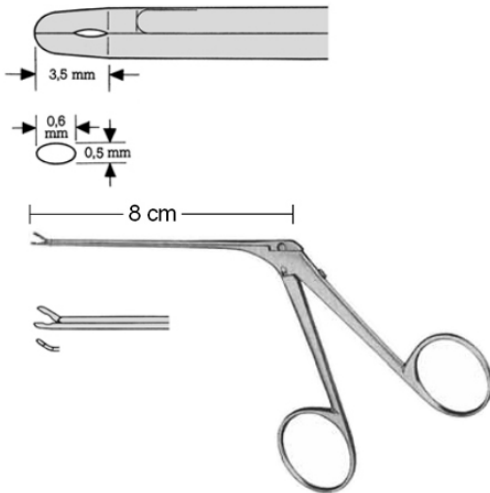

HARTMANN WULLSTEIN
AI-20-186-34
right

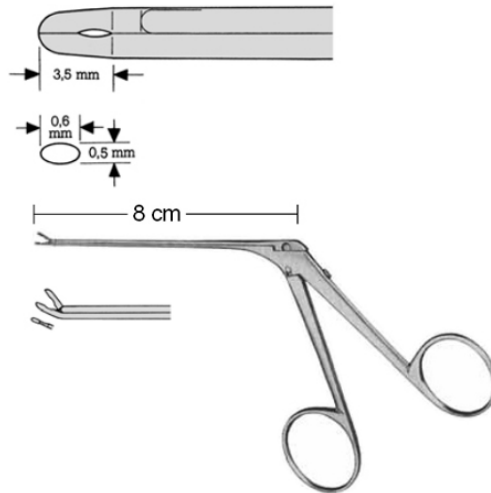

HARTMANN WULLSTEIN
AI-20-186-35
curved up

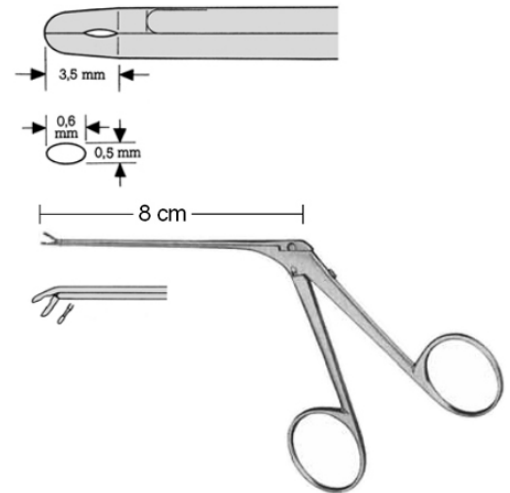

HARTMANN WULLSTEIN
AI-20-186-36
curved downwards

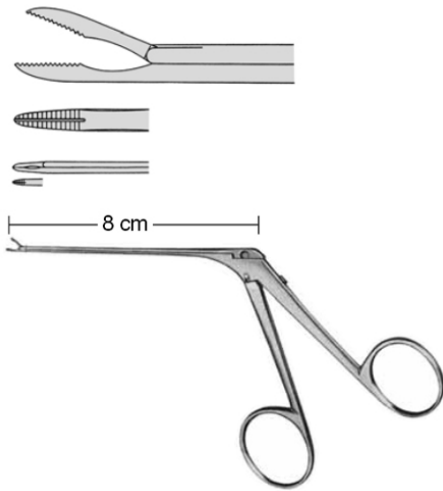

GREVEN
AI-20-186-37
GREVEN



WULLSTEIN
AI-20-186-38
WULLSTEIN
1 mm Ø, 2 mm Ø,

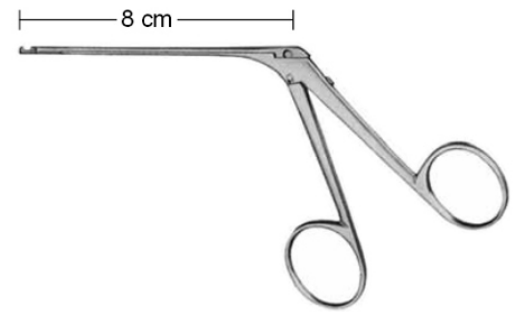

DIETER
AI-20-186-39
DIETER

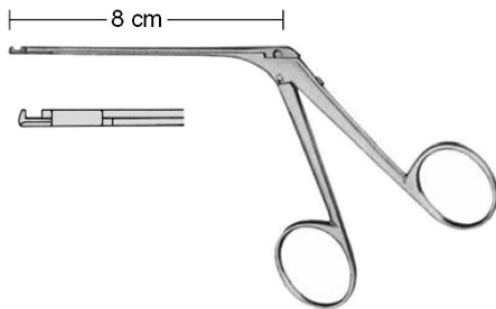

DIETER
AI-20-186-40
up-cutting

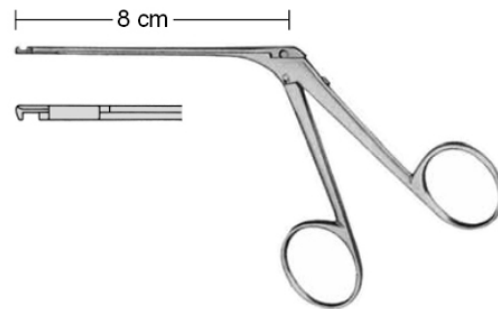

DIETER
AI-20-186-41
down-cutting



FULLER
AI-20-186-42
Introducing Forceps for Teflon prosthesis

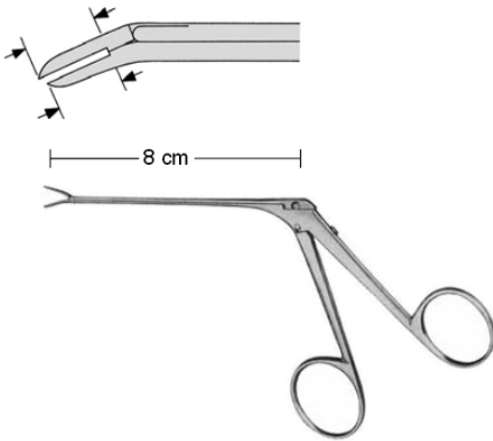

McGEE
AI-20-186-43
Wire Bending Forceps

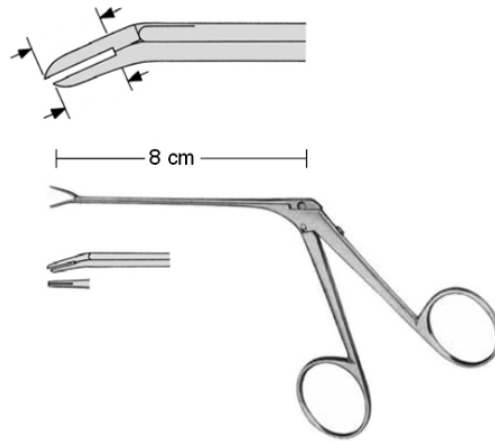

McGEE
AI-20-186-44
Wire Bending Forceps
0,8 x 3,5 mm,

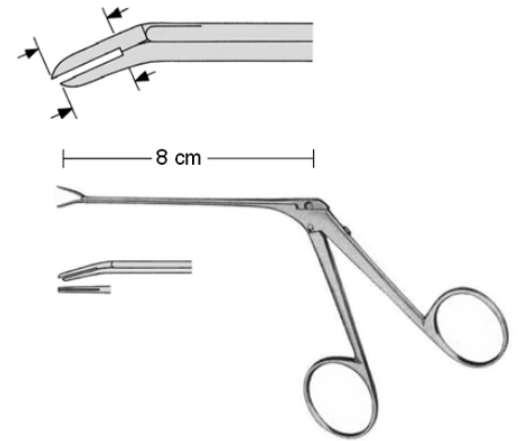

McGEE
AI-20-186-45
Wire Bending Forceps
0,8 x 6 mm,

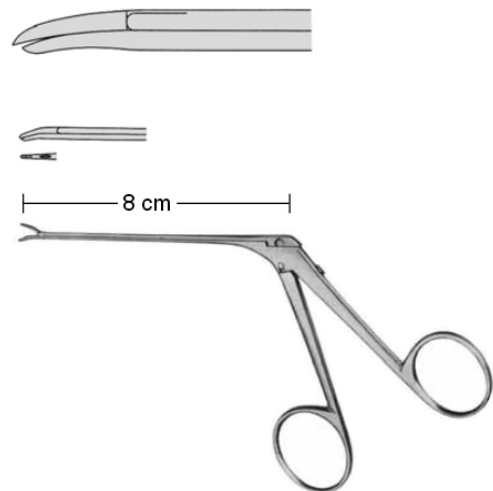

SCHUKNECHT
AI-20-186-46
SCHUKNECHT

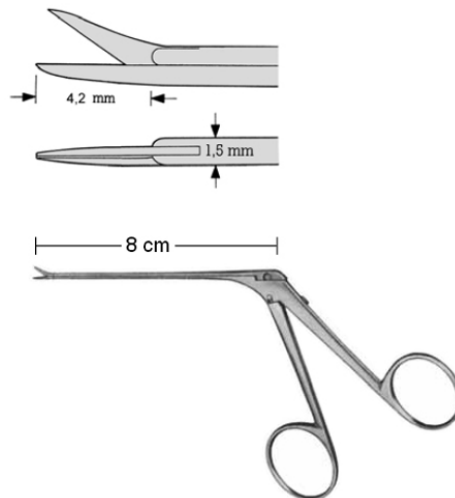

BELLUCCI
AI-20-186-47
BELLUCCI

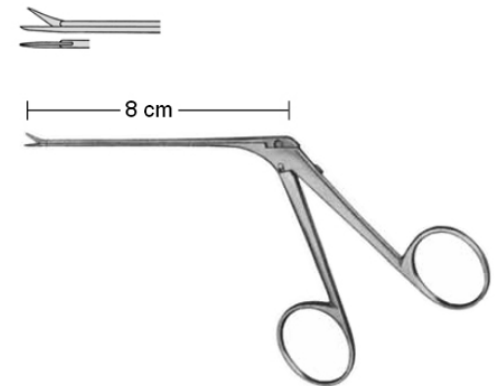

BELLUCCI
AI-20-186-48
straight

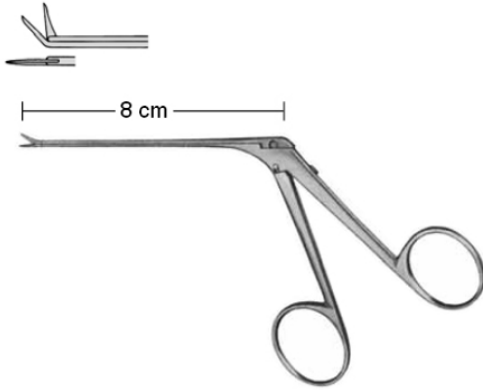

BELLUCCI
AI-20-186-49
curved up

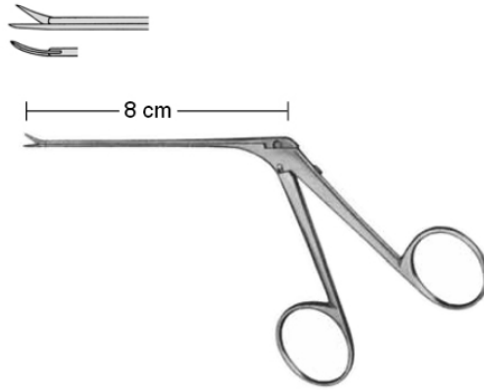

BELLUCCI
AI-20-186-50
right

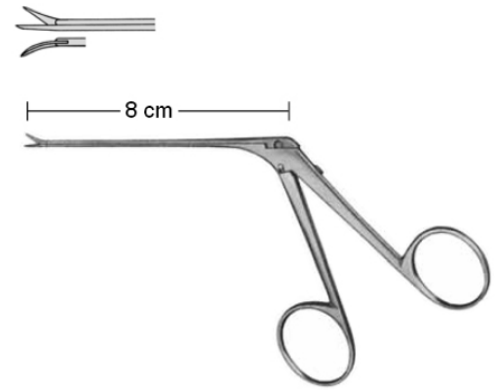

BELLUCCI
AI-20-186-51
left

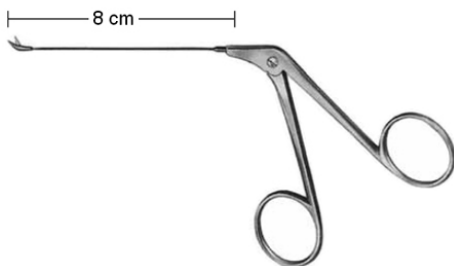
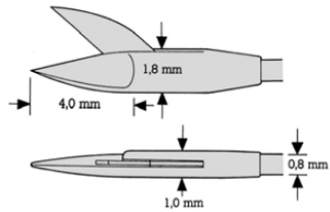

WULLSTEIN
AI-20-186-52
WULLSTEIN

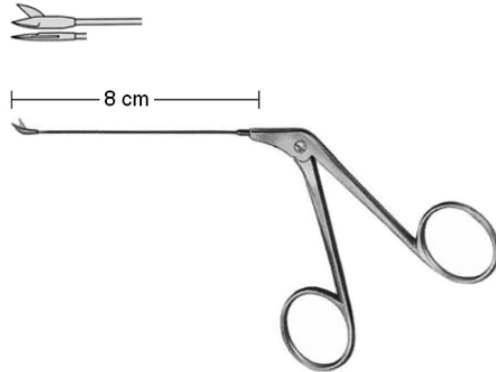

WULLSTEIN
AI-20-186-53
straight

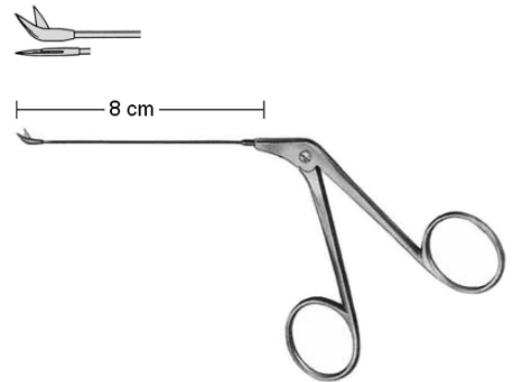

WULLSTEIN
AI-20-186-54
curved up

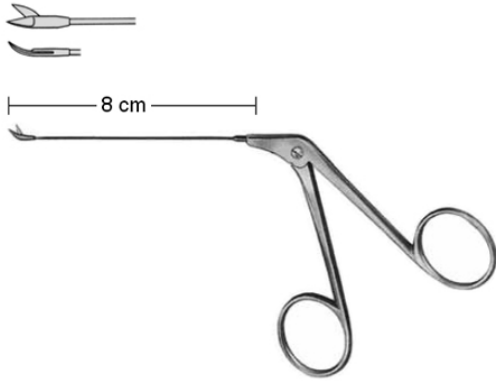

WULLSTEIN
AI-20-186-55
right

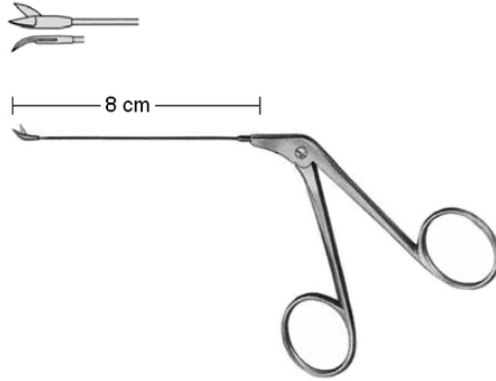

WULLSTEIN
AI-20-186-56
left

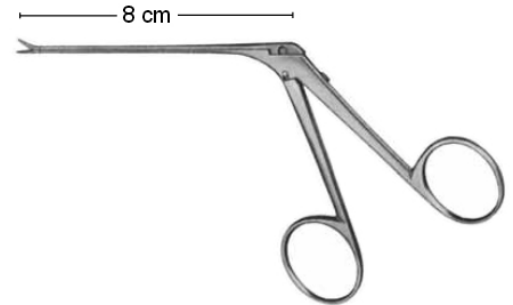

SHEA-BELLUCC
AI-20-186-57
SHEA-BELLUCC
7 mm,

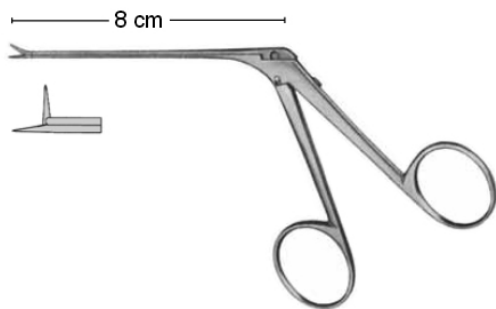

SHEA-BELLUCC
AI-20-186-58
straight

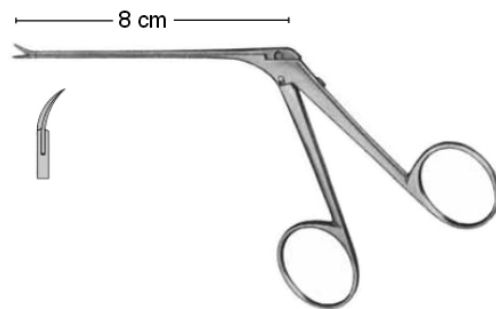

SHEA-BELLUCC
AI-20-186-59
curved up

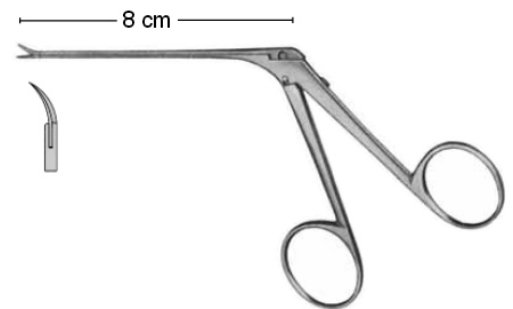

SHEA-BELLUCC
AI-20-186-60
right

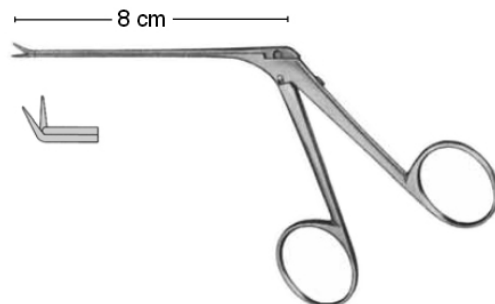

SHEA-BELLUCC
AI-20-186-61
left



JURASZ
AI-21-187-01
JURASZ
23 cm,

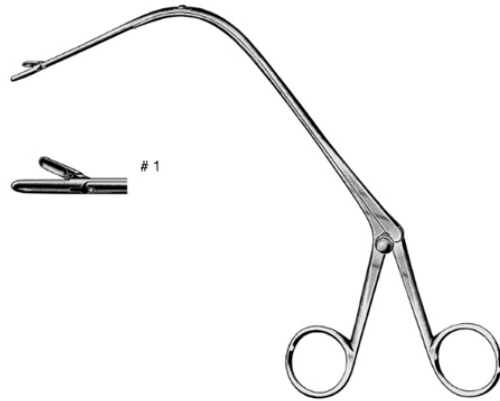

JURASZ
AI-21-187-02
opening right

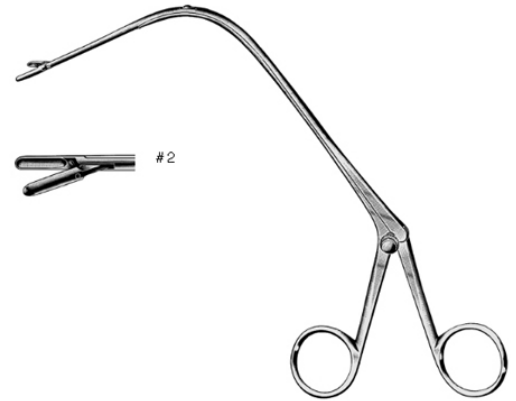

JURASZ
AI-21-187-03
opening left

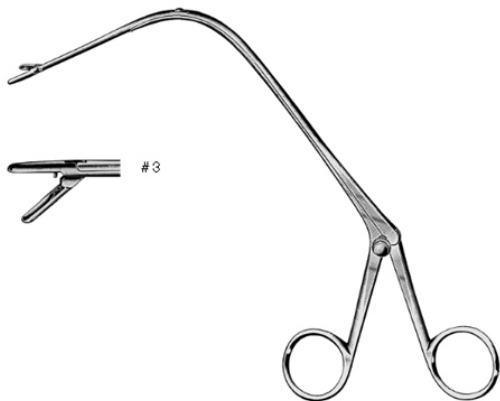

JURASZ
AI-21-187-04
opening downward

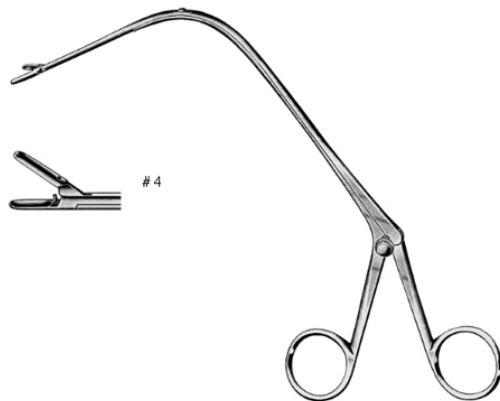

JURASZ
AI-21-187-05
opening upward



FRAENKEL
AI-21-187-06
both jaws articulated

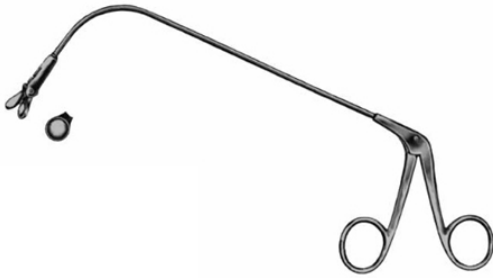

LANGE
AI-21-187-07
both jaws articulated



HUBER
AI-21-187-08
Universal Handle for extension tubes
35.0220 - 35.0320



BRUENINGS
AI-21-187-09
Extension Tubes
20 cm,30 cm,40 cm,50 cm,60 cm,



BRUENINGS
AI-21-187-10
BRUENINGS
20 cm,

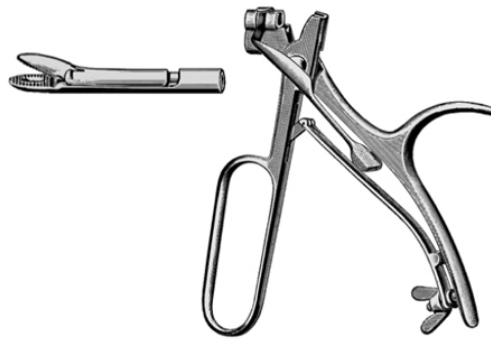

FRAENKEL
AI-21-187-11
EXCHANGEABLE TIPS

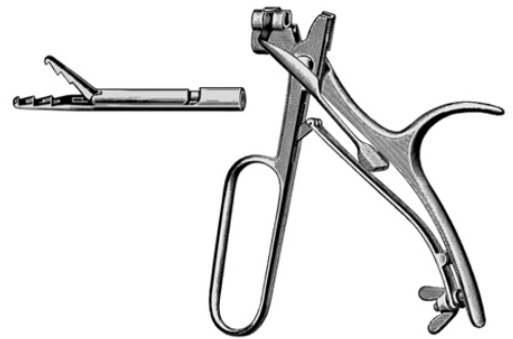

SEIFFERT
AI-21-187-12
EXCHANGEABLE TIPS

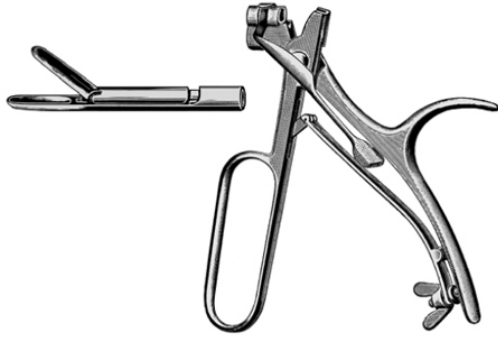

FRAENKEL
AI-21-187-13
EXCHANGEABLE TIPS

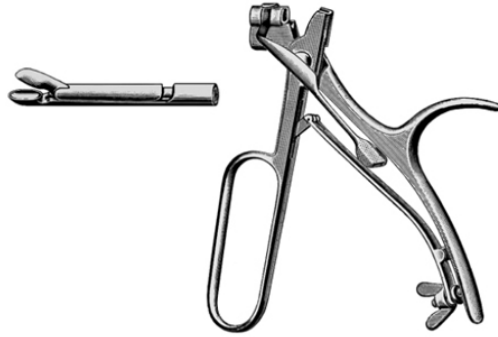

LANGE
AI-21-187-14
EXCHANGEABLE TIPS

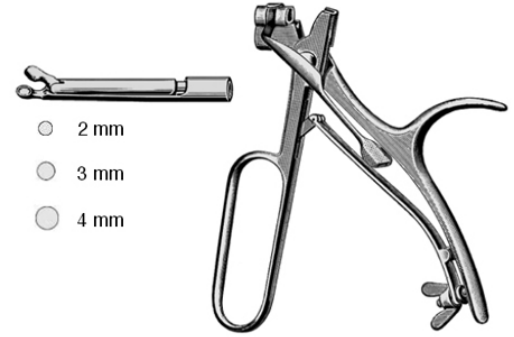

BRUENINGS
AI-21-187-15
EXCHANGEABLE TIPS
2 mm, 3 mm, 4 mm,

- 2 mm
- 3 mm
- 4 mm

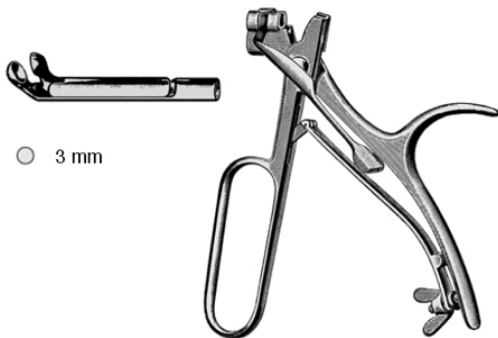

BRUENINGS
AI-21-187-16
EXCHANGEABLE TIPS
3 mm,

- 3 mm

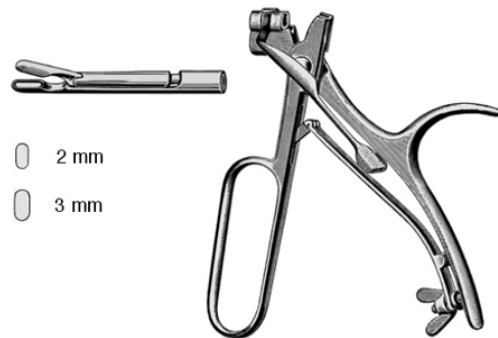

BRUENINGS
AI-21-187-17
EXCHANGEABLE TIPS
2 mm, 3 mm,

- 2 mm
- 3 mm

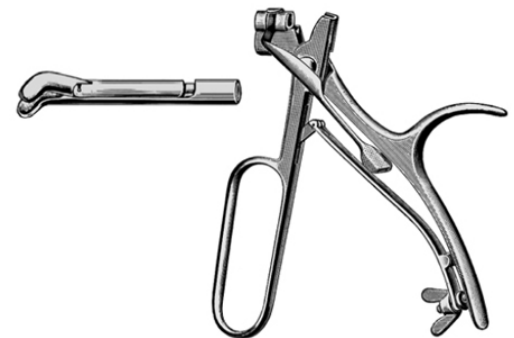

SCHEINMANN
AI-21-187-18
EXCHANGEABLE TIPS

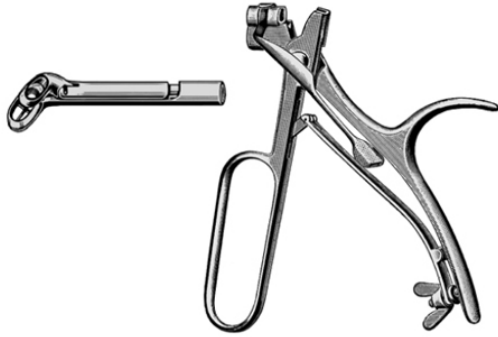

SCHEIMANN
AI-21-187-19
EXCHANGEABLE TIPS

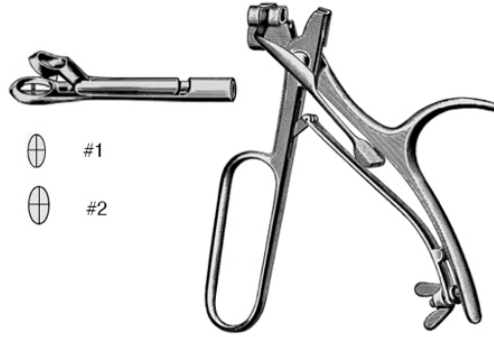

KRAUSE
AI-21-187-20
EXCHANGEABLE TIPS

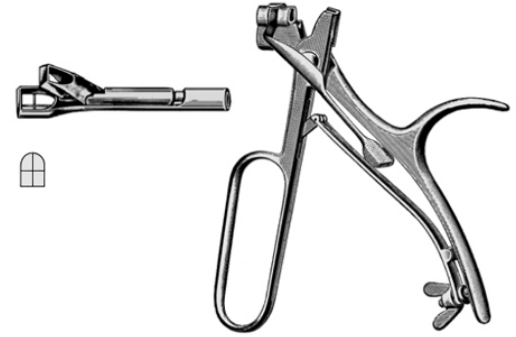

KRAUSE
AI-21-187-21
EXCHANGEABLE TIPS

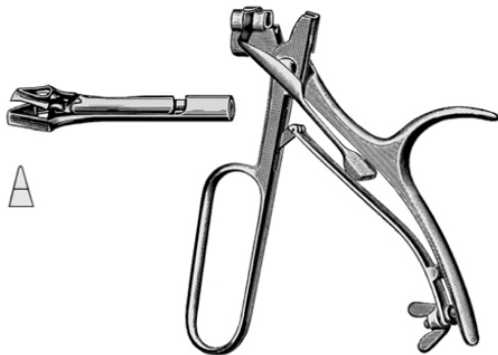

SCHUMACHER
AI-21-187-22
EXCHANGEABLE TIPS

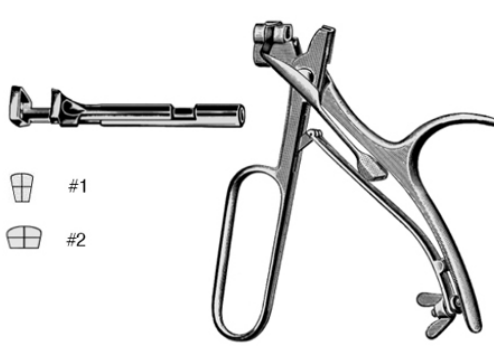

CORDES
AI-21-187-23
EXCHANGEABLE TIPS

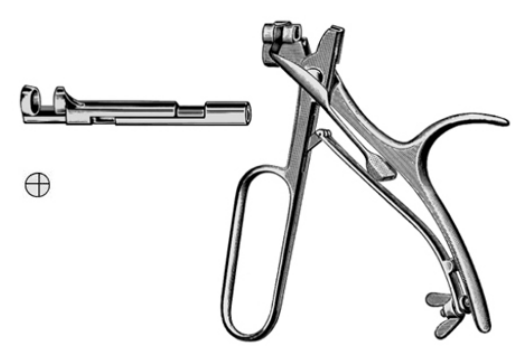

CORDES
AI-21-187-24
EXCHANGEABLE TIPS

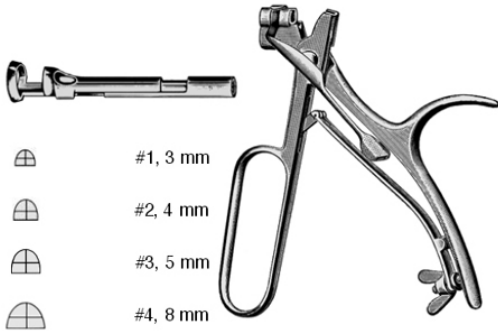

CORDES
AI-21-187-25
EXCHANGEABLE TIPS
3 mm,4 mm,5 mm,4,8 mm,

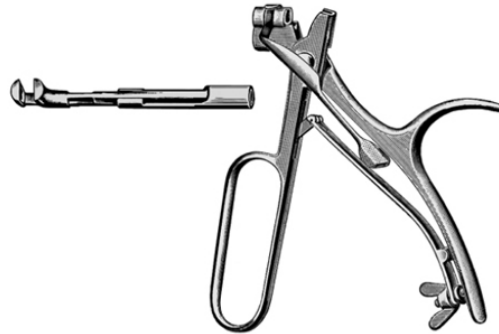

ROSENBERG
AI-21-187-26
EXCHANGEABLE TIPS



CHEVALIER-JACKSON
AI-21-187-27
CHEVALIER-JACKSON



CHEVALIER-JACKSON
AI-21-187-28
CHEVALIER-JACKSON
30 cm,40 cm,50 cm,60 cm,



CHEVALIER-JACKSON
AI-21-187-29
CHEVALIER-JACKSON
30 cm,40 cm,50 cm,60 cm,



CHEVALIER-JACKSON
AI-21-187-30
CHEVALIER-JACKSON
30 cm,40 cm,50 cm,60 cm,



CHEVALIER-JACKSON

AI-21-187-31

CHEVALIER-JACKSON
30 cm,40 cm,50 cm,60 cm,

CHEVALIER-JACKSON

AI-21-187-32

CHEVALIER-JACKSON
30 cm,40 cm,50 cm,60 cm,

CHEVALIER-JACKSON

AI-21-187-33

CHEVALIER-JACKSON
30 cm,40 cm,50 cm,60 cm,



CHEVALIER-JACKSON

AI-21-187-34

CHEVALIER-JACKSON
30 cm,40 cm,50 cm,60 cm,

LARYNGO-Bronchoscopy

AI-21-187-35

LARYNGO-Bronchoscopy
Shaft Ø 2,5 mm,

LARYNGO-Bronchoscopy

AI-21-187-36

LARYNGO-Bronchoscopy
40 cm,50 cm,60 cm,

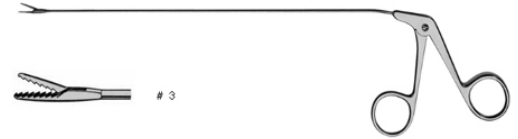
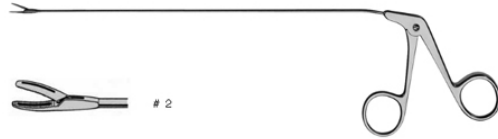
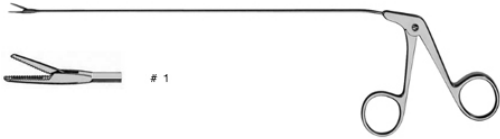

LARYNGO-Bronchoscopy
AI-21-187-37
LARYNGO-Bronchoscopy
40 cm,50 cm,60 cm,

LARYNGO-Bronchoscopy
AI-21-187-38
LARYNGO-Bronchoscopy
40 cm,50 cm,60 cm,

LARYNGO-Bronchoscopy
AI-21-187-39
LARYNGO-Bronchoscopy
40 cm,50 cm,60 cm,



LARYNGO-Bronchoscopy
AI-21-187-40
LARYNGO-Bronchoscopy
40 cm,50 cm,60 cm,

LARYNGO-Bronchoscopy
AI-21-187-41
LARYNGO-Bronchoscopy
40 cm,50 cm,60 cm,

LARYNGO-Bronchoscopy
AI-21-187-42
LARYNGO-Bronchoscopy
40 cm,50 cm,60 cm,

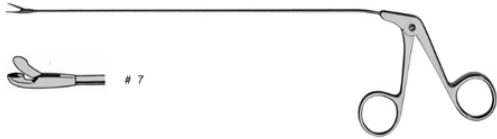

LARYNGO-Bronchoscopy
AI-21-187-43
LARYNGO-Bronchoscopy
40 cm,50 cm,60 cm,

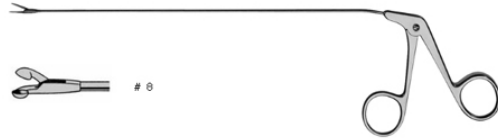

LARYNGO-Bronchoscopy
AI-21-187-44
LARYNGO-Bronchoscopy
40 cm,50 cm,60 cm,

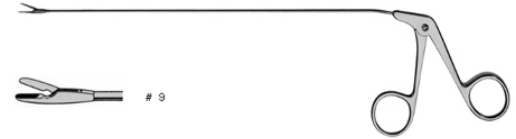

LARYNGO-Bronchoscopy
AI-21-187-45
LARYNGO-Bronchoscopy
40 cm,50 cm,60 cm,



LARYNGO-Bronchoscopy
AI-21-187-46
LARYNGO-Bronchoscopy
40 cm,50 cm,60 cm,



LARYNGO-Bronchoscopy
AI-21-187-47
LARYNGO-Bronchoscopy
40 cm,50 cm,60 cm,



LARYNGO-Bronchoscopy
AI-21-187-48
LARYNGO-Bronchoscopy
40 cm,50 cm,60 cm,

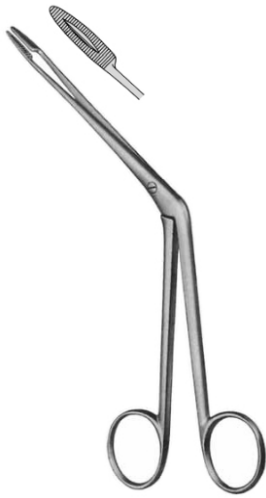

HARTMANN
AI-22-188-01
HARTMANN
20 cm,



HARTMANN
AI-22-188-02
HARTMANN
16 cm,



LITTAUER
AI-22-188-03
LITTAUER
18 cm,

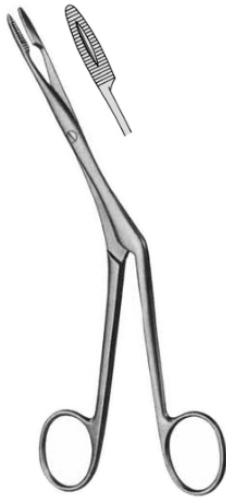

KNIGHT
AI-22-188-04
KNIGHT
18 cm,

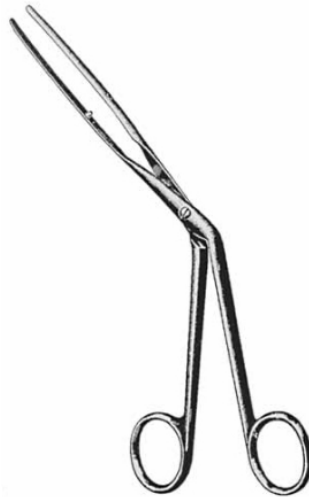

LUBET-BARBON
AI-22-188-05
LUBET-BARBON
20 cm,

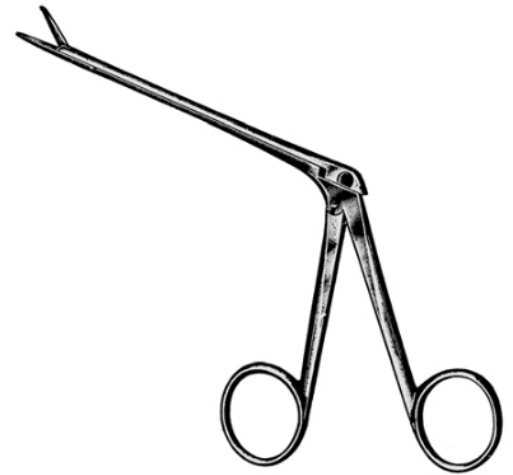

NOYES
AI-22-188-06
NOYES



NOYES
AI-22-188-07
NOYES
14,5,



NOYES
AI-22-188-08
NOYES
14,5 cm, 1x2,



BRUENINGS
AI-22-188-09
BRUENINGS
19 cm,



BRUENINGS
AI-22-188-10
BRUENINGS



BRUENINGS
AI-22-188-11
BRUENINGS

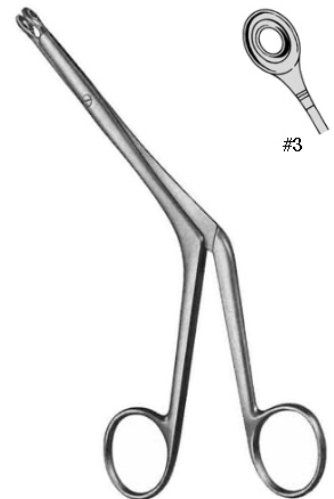

BRUENINGS
AI-22-188-12
BRUENINGS

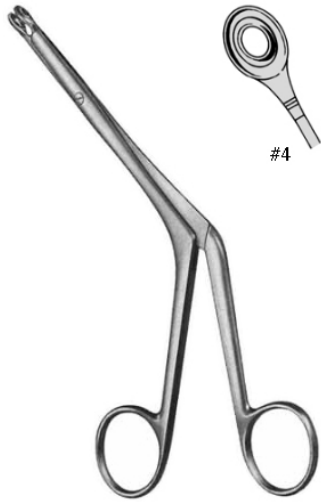

BRUENINGS
AI-22-188-13
BRUENINGS



HEYMANN
AI-22-188-14
HEYMANN
18 cm,



HEYMANN
AI-22-188-15
HEYMANN



HEYMANN
AI-22-188-16
HEYMANN

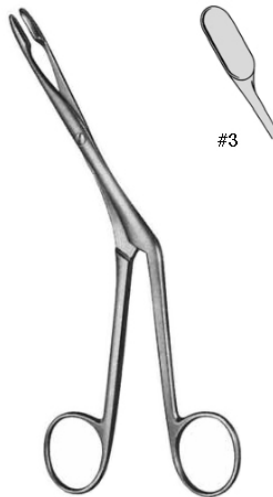

HEYMANN
AI-22-188-17
HEYMANN

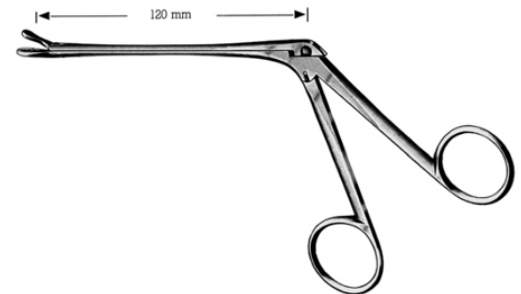

WATSON-WILLIAMS
AI-22-188-18
WATSON-WILLIAMS
19 cm,

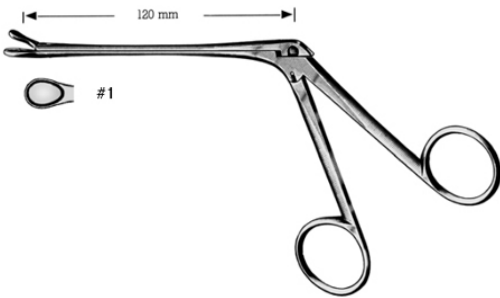

WATSON-WILLIAMS
AI-22-188-19
WATSON-WILLIAMS

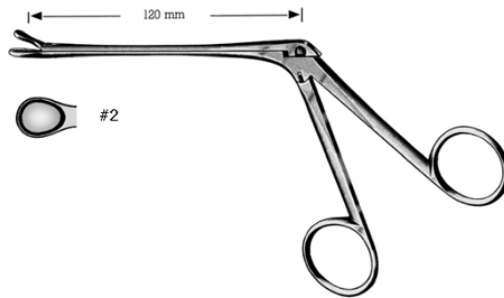

WATSON-WILLIAMS
AI-22-188-20
WATSON-WILLIAMS

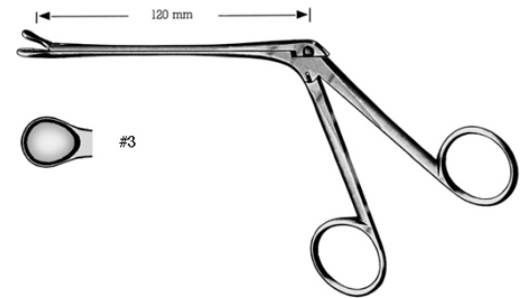

WATSON-WILLIAMS
AI-22-188-21
WATSON-WILLIAMS

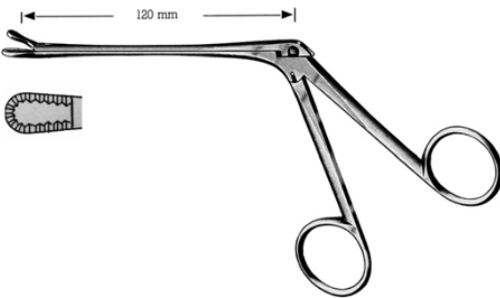

WATSON-WILLIAMS
AI-22-188-22
WATSON-WILLIAMS

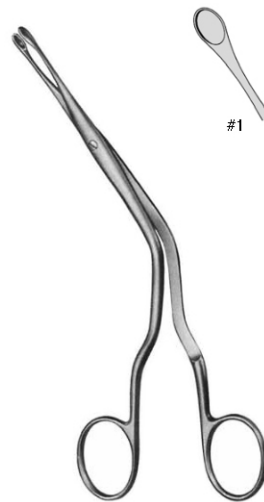

LUC
AI-22-188-23
LUC
19 cm,

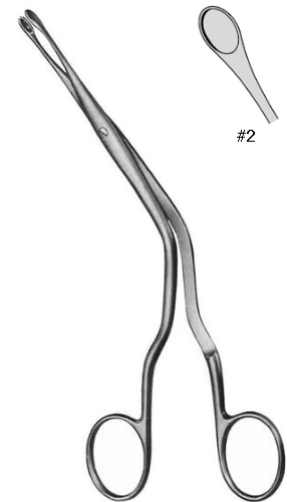

LUC
AI-22-188-24
LUC
19 cm,

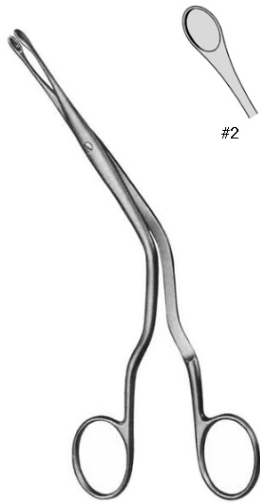

LUC
AI-22-188-25
LUC
19 cm,

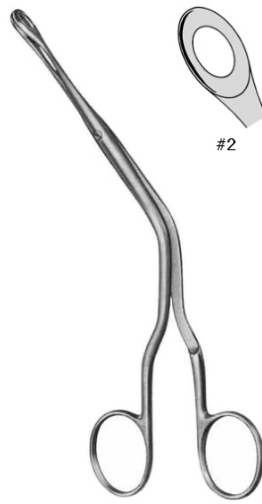

LUC
AI-22-188-26
LUC
19 cm,

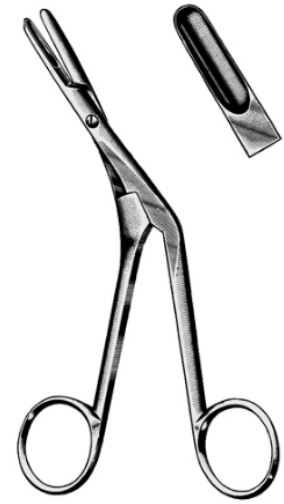

CRAIG
AI-22-188-27
CRAIG
18 cm,



CRAIG
AI-22-188-28
CRAIG
18 cm,



CRAIG
AI-22-188-29
CRAIG
18 cm,

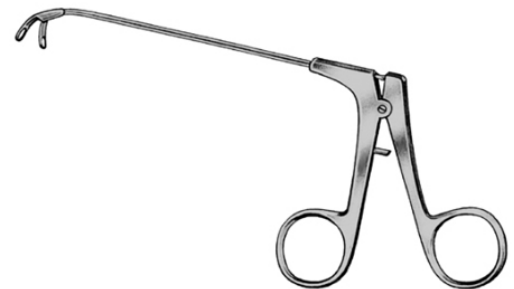

HEUWIESER
AI-22-188-30
Antrum polypus grasping forceps

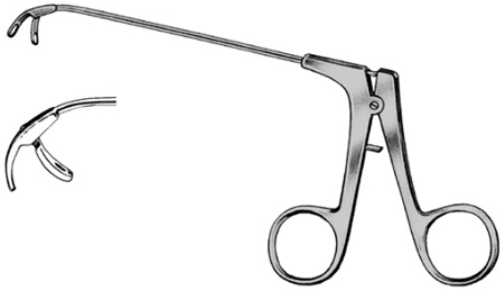

HEUWIESER
AI-22-188-31
down

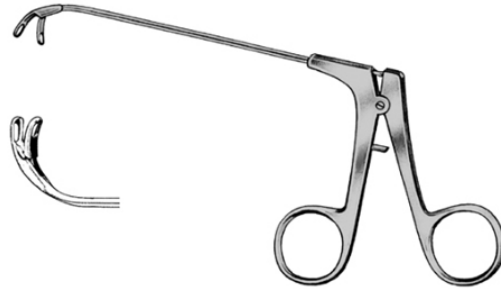

HEUWIESER
AI-22-188-32
up

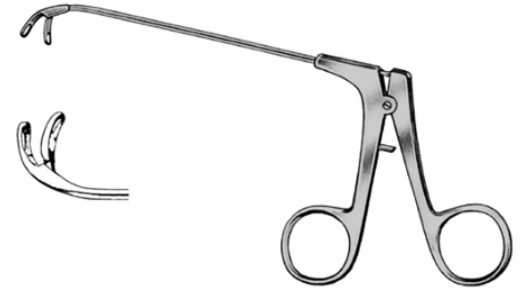

HEUWIESER
AI-22-188-33
right

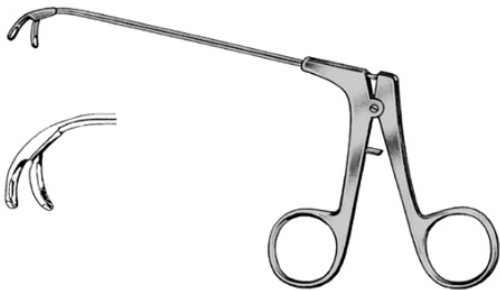

HEUWIESER
AI-22-188-34
left



JANSEN-MIDDLETON
AI-22-188-35
JANSEN-MIDDLETON
19 cm,



JANSEN-MIDDLETON
AI-22-188-36
JANSEN-MIDDLETON
19 cm,

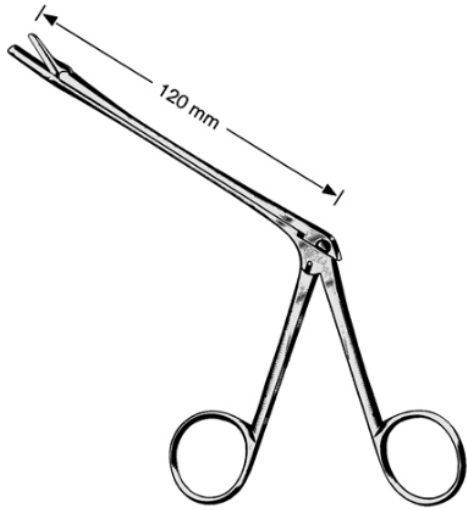

STRUYCKEN
AI-22-188-37
STRUYCKEN
19 cm,



SCHMEDEN
AI-22-188-38
SCHMEDEN
11 mm,



STRUYCKEN
AI-22-188-39
STRUYCKEN



STRUYCKEN
AI-22-188-40
STRUYCKEN

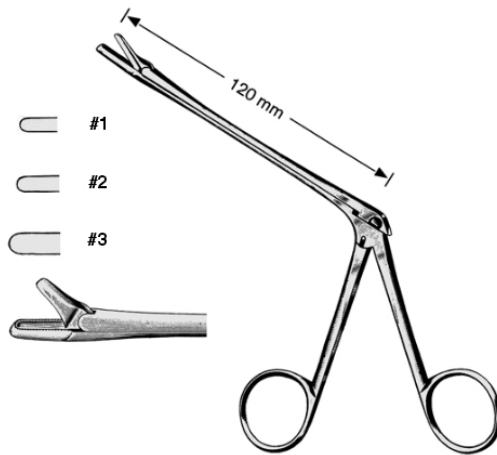

MYLES
AI-22-188-41
MYLES

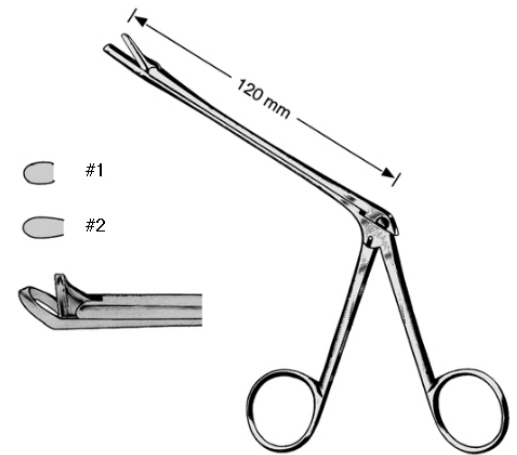

WATSON-WILLIAMS
AI-22-188-42
WATSON-WILLIAMS
13 cm,

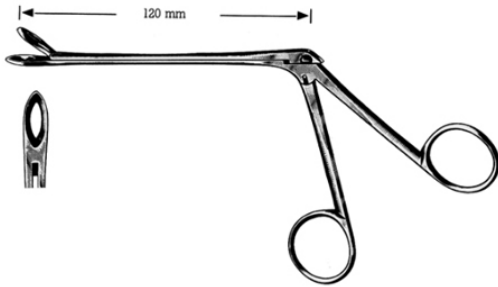

WEIL-BLAKESLEY
AI-22-188-43
without neck
19 cm,

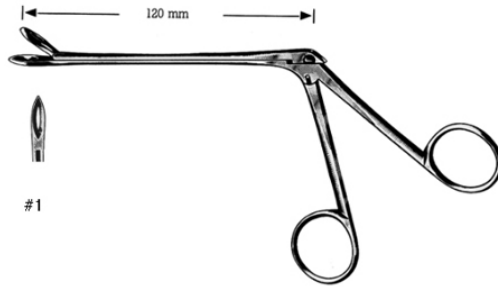

WEIL-BLAKESLEY
AI-22-188-44
WEIL-BLAKESLEY

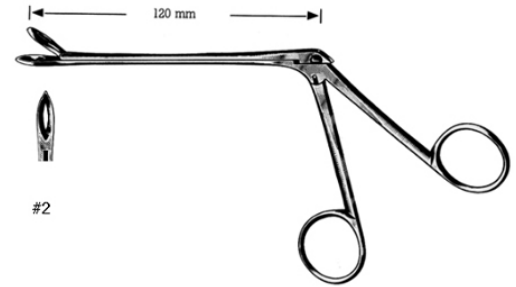

WEIL-BLAKESLEY
AI-22-188-45
WEIL-BLAKESLEY

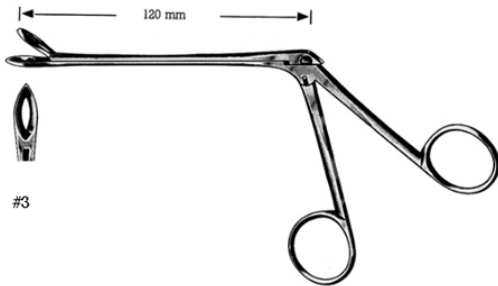

WEIL-BLAKESLEY
AI-22-188-46
without neck

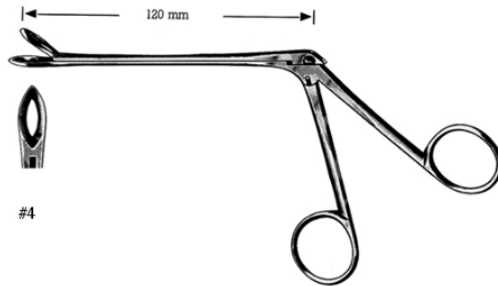

WEIL-BLAKESLEY
AI-22-188-47
without neck

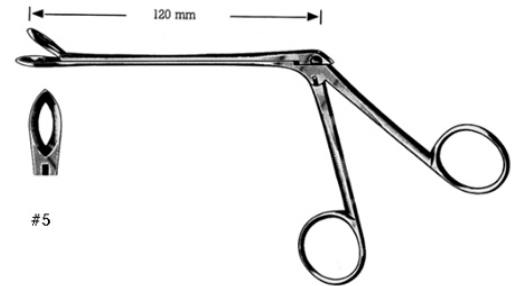

WEIL-BLAKESLEY
AI-22-188-48
without neck

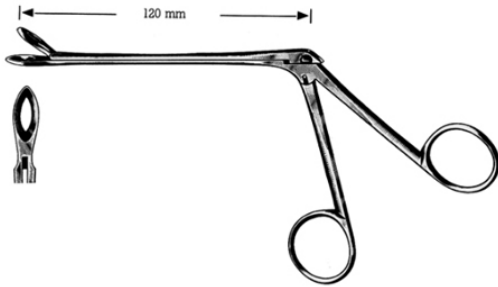

WEIL-BLAKESLEY
AI-22-188-49
with neck
19 cm,

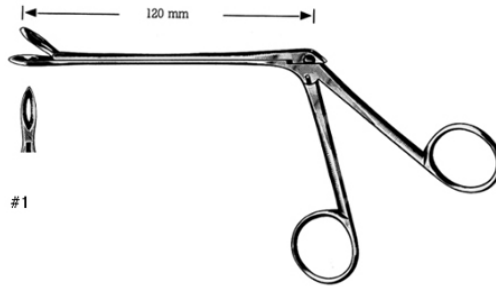

WEIL-BLAKESLEY
AI-22-188-50
with neck

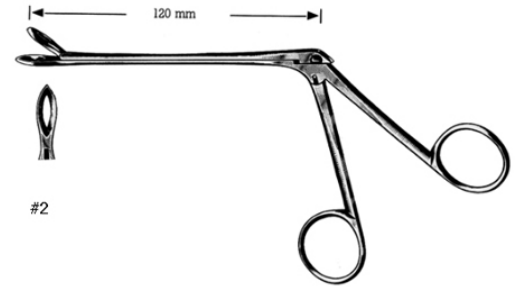

WEIL-BLAKESLEY
AI-22-188-51
with neck

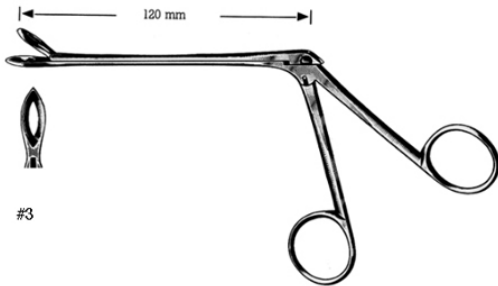

WEIL-BLAKESLEY
AI-22-188-52
with neck

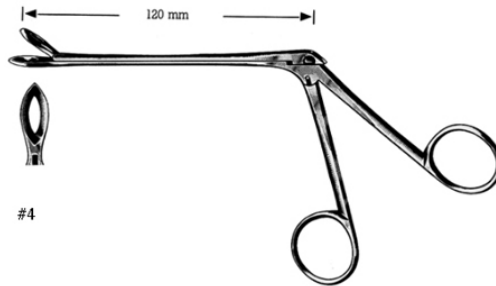

WEIL-BLAKESLEY
AI-22-188-53
with neck

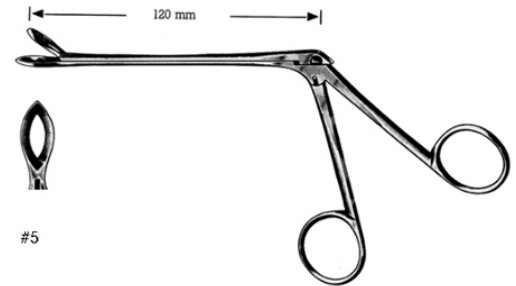

WEIL-BLAKESLEY
AI-22-188-54
with neck



WEIL-BLAKESLEY
AI-22-188-55
WEIL-BLAKESLEY
20 cm,

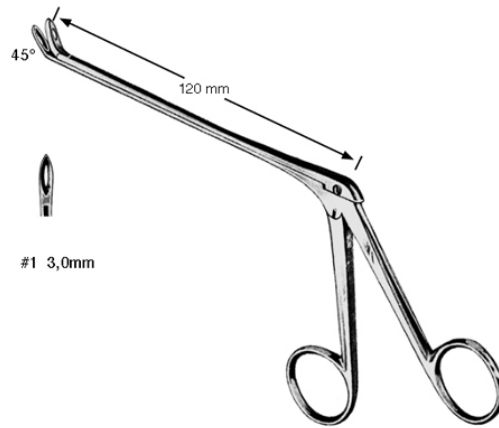

WEIL-BLAKESLEY
AI-22-188-56
WEIL-BLAKESLEY
3,0mm,

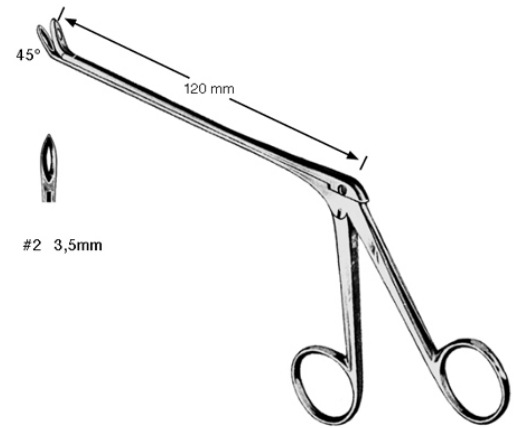

WEIL-BLAKESLEY
AI-22-188-57
WEIL-BLAKESLEY
3,5mm,



WEIL-BLAKESLEY
AI-22-188-58
WEIL-BLAKESLEY
4,0mm,

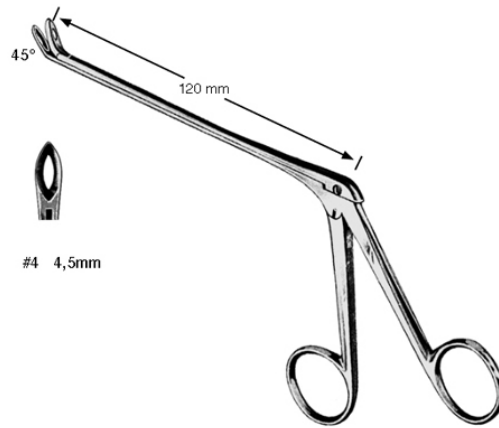

WEIL-BLAKESLEY
AI-22-188-59
WEIL-BLAKESLEY
4,5mm,



WEIL-BLAKESLEY
AI-22-188-60
WEIL-BLAKESLEY
5,5mm,



WEIL-BLAKESLEY
AI-22-188-61
WEIL-BLAKESLEY

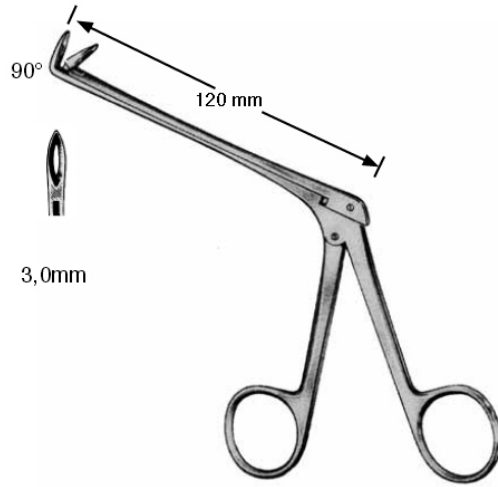

WEIL-BLAKESLEY
AI-22-188-62
WEIL-BLAKESLEY
3,0mm,



WEIL-BLAKESLEY
AI-22-188-63
WEIL-BLAKESLEY
3,5mm,

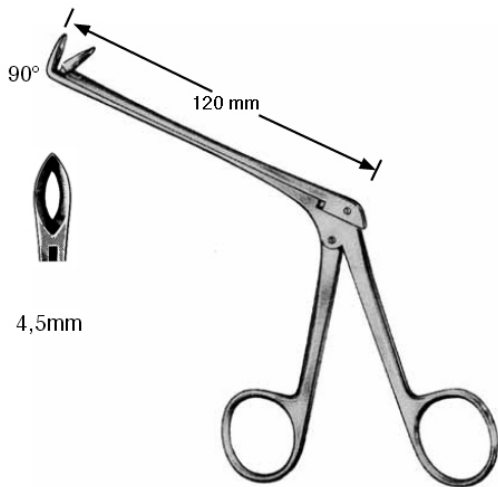

WEIL-BLAKESLEY
AI-22-188-64
WEIL-BLAKESLEY
4,5mm,



WEIL-BLAKESLEY
AI-22-188-65
WEIL-BLAKESLEY
5,0mm,

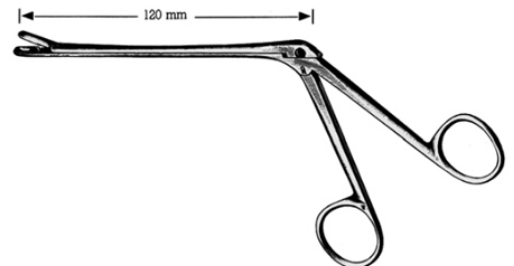

TAKAHASHI
AI-22-188-66
TAKAHASHI
19 cm,

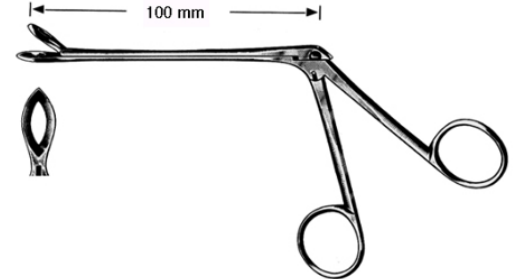
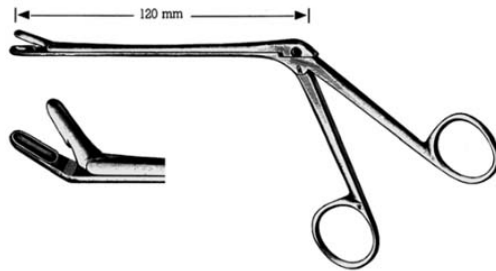
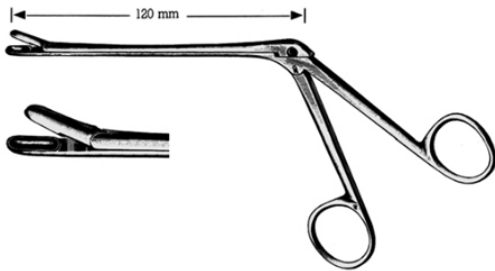

TAKAHASHI
AI-22-188-67
TAKAHASHI
2x10 mm, 3x10 mm, 4x10 mm,

TAKAHASHI
AI-22-188-68
TAKAHASHI
2x10 mm, 3x10 mm, 4x10 mm,

TILLEY-HENCKEL
AI-22-188-69
TILLEY-HENCKEL
6,5 mm,

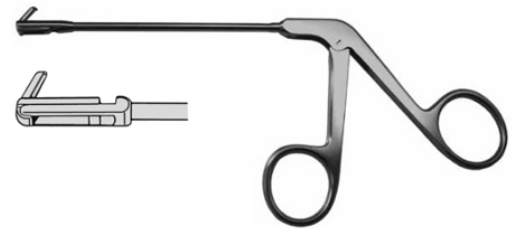

OSTROM
AI-22-188-70
without illustration: rotating
100 mm,

OSTROM
AI-22-188-71
upside backward cutting

OSTROM
AI-22-188-72
right side, backward cutting



OSTROM
AI-22-188-73
left side, backward cutting



HARTMANN
AI-22-188-74
HARTMANN



HARTMANN
AI-22-188-75
HARTMANN
5 mm,

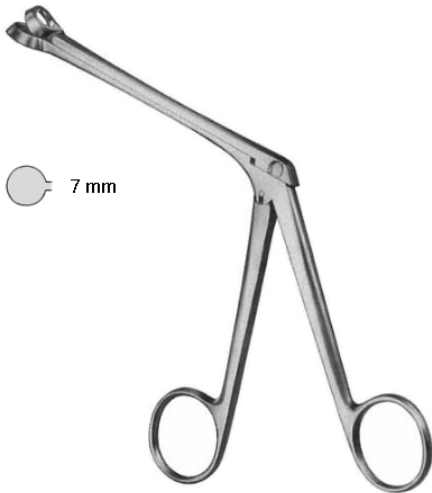

HARTMANN
AI-22-188-76
HARTMANN
7 mm,

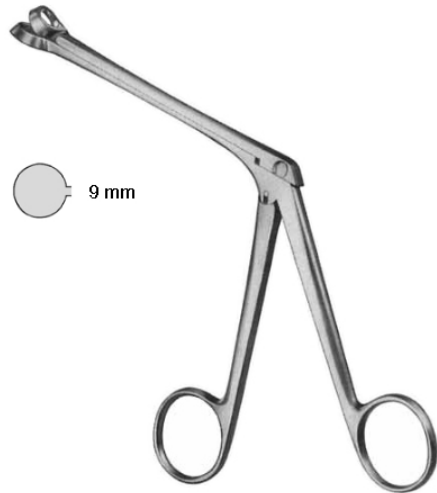

HARTMANN
AI-22-188-77
HARTMANN
9 mm,

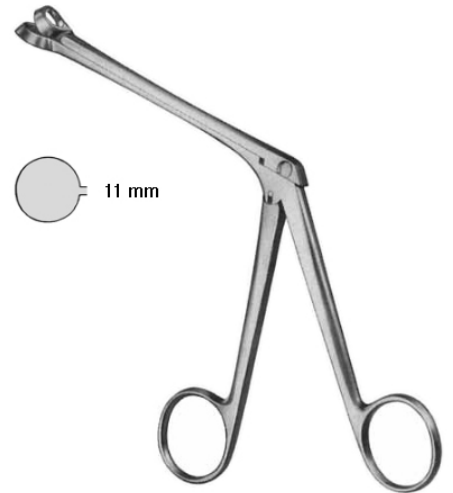

HARTMANN
AI-22-188-78
HARTMANN
11 mm,

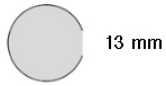
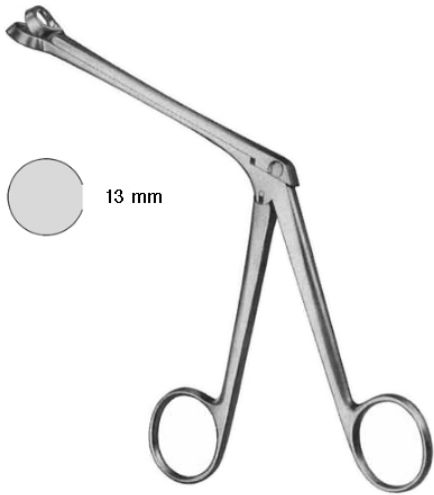

13 mm

HARTMANN
AI-22-188-79
HARTMANN
13 mm,

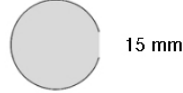
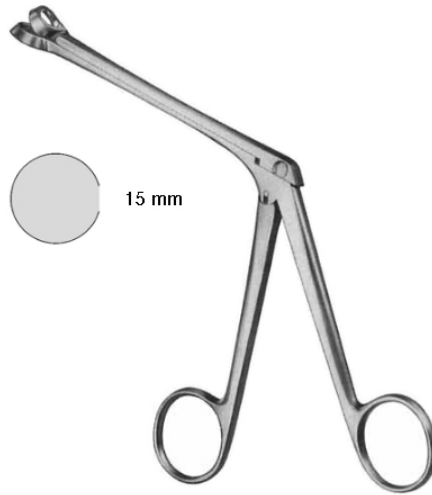

15 mm

HARTMANN
AI-22-188-80
HARTMANN
15 mm,

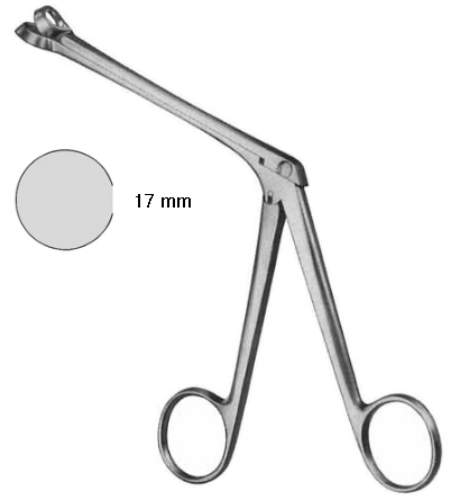

17 mm

HARTMANN
AI-22-188-81
HARTMANN
17 mm,

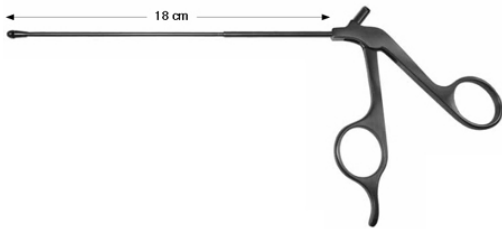

18 cm

STAMMBERGER
AI-22-188-82
STAMMBERGER
27 cm,

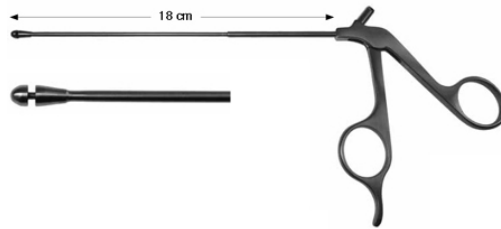

18 cm

STAMMBERGER
AI-22-188-83
straight
Ø 3,5 mm ,

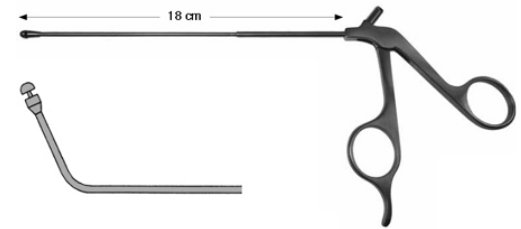

18 cm

STAMMBERGER
AI-22-188-84
up-curved
65° Ø 3,5 mm ,65° Ø 4,5 mm ,



KERRISON

AI-22-188-85

KERRISON

3 mm, 4 mm, 5 mm, 6 mm,



HAJEK-KOFLER

AI-22-188-86

HAJEK-KOFLER

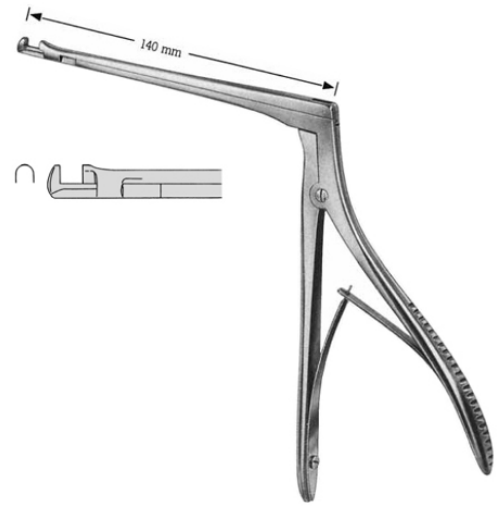

HAJEK-KOFLER

AI-22-188-87

HAJEK-KOFLER

3,5 mm,

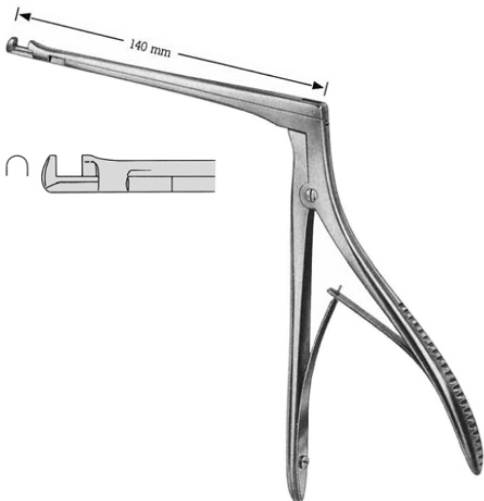

HAJEK-KOFLER

AI-22-188-88

HAJEK-KOFLER

4 mm,

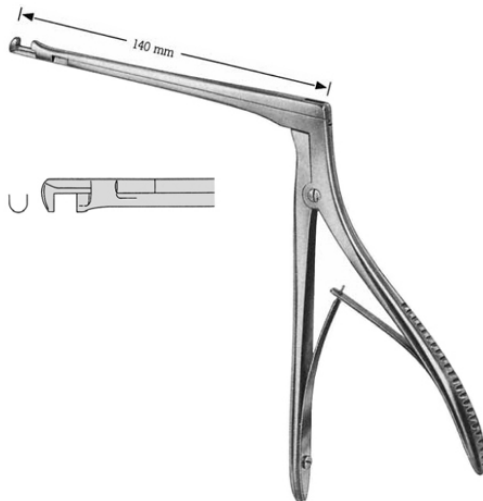

HAJEK-KOFLER

AI-22-188-89

HAJEK-KOFLER

3,5 mm,



HAJEK-KOFLER

AI-22-188-90

HAJEK-KOFLER

4 mm,



HAJEK-CLAUS
AI-22-188-91
HAJEK-CLAUS
20 cm,



CITELLI
AI-22-188-92
CITELLI
5 mm, 2 mm, 3 mm,



BEYER
AI-22-188-93
BEYER
18 cm, 2 mm,



CONTACT US

Address: P.O.Box 1176 Small Industries Estate Sialkot Pakistan.

Fax: +92-52-3550178

Tell: +92-52-3256447

E-mail: mriaz@skt.comsats.net.pk

USA OFFICE

Address: P.O.Box 190279 Brooklyn 11219.N.Y.USA.

E-mail: aurigainc@hotmail.com