

# DENTAL INSTRUMENTS CATALOGUE



**AURIGA**  
INTERNATIONAL

Manufacture & Exporter of High Quality Dental Instruments.

## Dear Valued Buyers

We feel immense pleasure to present our latest catalogue in which we have featured a most comprehensive range of all types of quality Surgical & Dental instruments required for day to day use for Hospital & Dentist. We will be pleased to quote you a competitive Price and Delivery time.

All instruments are manufactured according to the recognized standard patterns currently in use in Hospital throughout the world and are being produced under restrict control of experts to avoid any flaw and to refrain any complaint at any stage.

A group of very vast experienced persons in manufacturing handling our quality Control System.

Any instruments proven defective in workmanship or material will be replaced with out charges.

We express our thanks to all our customers for the confidence they have placed us in the past. We further assure them that we will continue our best efforts to gain their confidence in the future.

We are always at your service.

Chief Executive

**AURIGA**  
INTERNATIONAL



01

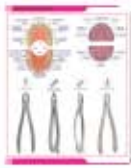

**EXTRACTING FORCEPS**

Page # 01 - 14H

02



**ROOT ELEVATORS**

Page # 15 - 29

03



**DIAGNOSTIC, PROBES, SCALERS, FILLING  
& LABORATORY INSTRUMENTS**

Page # 30 - 77

04



**MAXILLOFACIAL SURGERY  
INSTRUMENTS**

Page # 78 - 95

05



**ORTHODONTIC INSTRUMENTS  
& PLIERS**

Page # 96 - 107

06



**DENTAL IMPLANT INSTRUMENTS**

Page # 108 - 142

07

**impression Tray & Hollow wares**

Page # 143 - 151

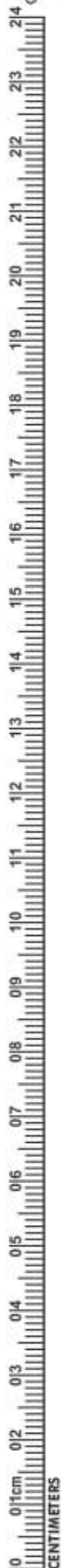

CENTIMETERS

# EXTRACTING FORCEPS

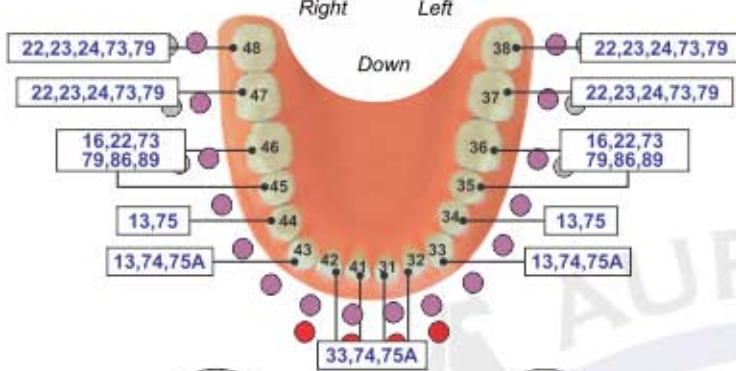
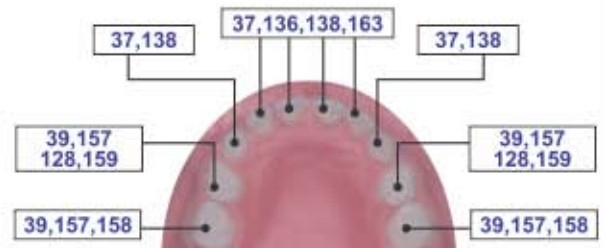
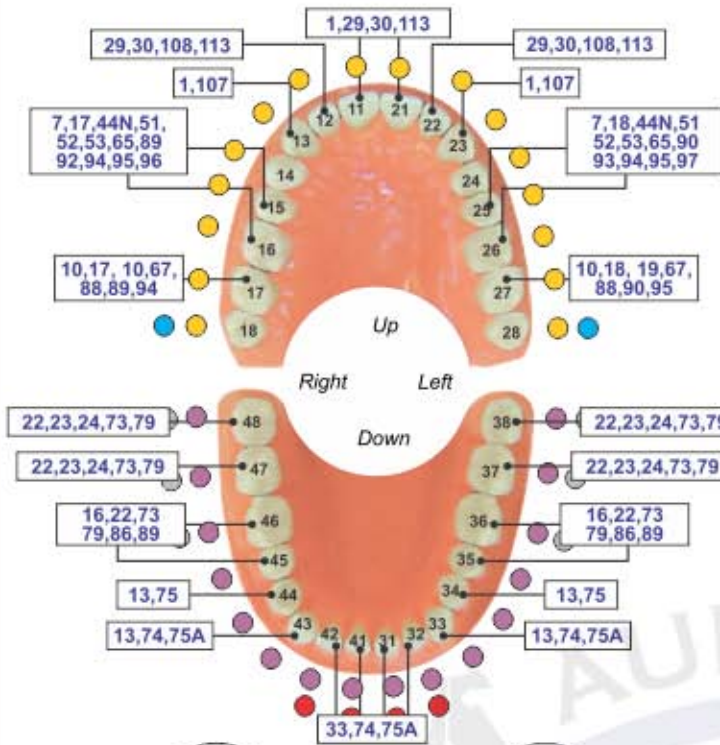

English Pattern



English Pattern, Anatomic Handle



American Pattern



Deep Grip Forceps



## EXTRACTING FORCEPS (English Pattern)

- Щипцы экстракционные (английская форма)
- Daviers (Forme Anglaise)
- Zahnzangen (Englische Form)

- Щипці екстракційні (англійська форма)
- Forceps de Extracción (Forme Inglesa)
- استخراج المنقط (نمط اللغة الإنجليزية)

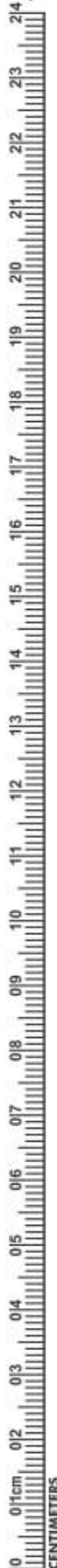

**DE-001**  
Fig. 1  
Upper Centrals  
and Canines



**DE-002**  
Fig. 2  
Upper Laterals  
and Canines



**DE-003**  
Fig. 4  
Lower Incisors  
and Canines



**DE-004**  
Fig. 7  
Upper Premolars



**DE-005**  
Fig. 8  
Lower Premolars



**DE-006**  
Fig. 13  
Lower Premolars



**DE-007**  
Fig. 17  
Upper Molars,  
Right



**DE-008**  
Fig. 18  
Upper Molars,  
Left



**DE-009**  
Fig. 21  
Lower Molar



**DE-010**  
Fig. 22  
Lower Molar

# EXTRACTING FORCEPS (English Pattern)

- Щипцы экстракционные (английская форма)
- Щипці екстракційні (англійська форма)
- Daviers (Forme Anglaise)
- Forceps de Extracción (Forme Inglesa)
- Zahnzangen (Englische Form)
- استخراج المنقذ (نمط اللغة الإنجليزية)



DE-011  
# 18A  
upper molars



DE-012  
# 19  
upper third molars



DE-013  
# 20  
lower third molar



DE-014  
# 24  
lower molar, right



DE-015  
# 29  
upper roots

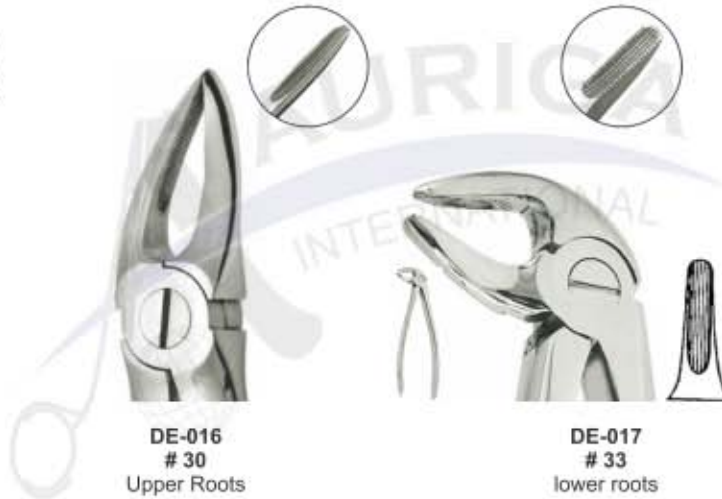

DE-016  
# 30  
Upper Roots



DE-017  
# 33  
lower roots



DE-018  
# 33A  
Lower Roots



DE-019  
# 33M  
Lower roots  
with long beak



DE-020  
# 46L  
Upper Roots



DE-021  
# 51  
Upper Roots



DE-022  
# 51A  
Upper Roots



# EXTRACTING FORCEPS (English Pattern)

- Щипцы экстракционные (английская форма)
- Давиеры (Forme Anglaise)
- Zahnzangen (Englische Form)
- Щипці екстракційні (англійська форма)
- Forceps de Extracción (Forme Inglesa)
- استخراج المنقط (نمط اللغة الإنجليزية)

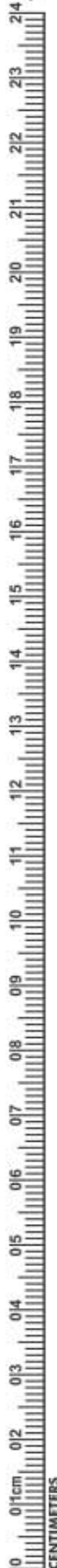

## WISDOM EXTRACTING FORCEPS



**DE-023**  
Routurier  
(# 22 1/2 L)  
lower molars and  
wisdoms, left

**DE-024**  
Routurier  
(# 22 1/2 R)  
lower molars and  
wisdoms, right



**DE-025**  
Routurier  
(# 33 1/2 L)  
lower molar and  
wisdom roots, left

**DE-026**  
Routurier  
(# 33 1/2 R)  
lower molar and  
wisdom roots, right



**DE-027**  
Fig. 186L  
lower molars



**DE-028**  
Fig. 186R  
lower molars



**DE-029**  
# 51A1



**DE-030**  
# 67  
Upper Third Molars



**DE-031**  
# 67A  
Upper Third Molars



**DE-032**  
# 79  
Lower Third Molars

# EXTRACTING FORCEPS (English Pattern)

- Щипцы экстракционные (английская форма)
- Daviers (Forme Anglaise)
- Zahnzangen (Englische Form)
- Щипці екстракційні (англійська форма)
- Forceps de Extracción (Forme Inglesa)
- استخراج المنقط (نمط اللغة الإنجليزية)



**DE-033**  
**# 73**  
Lower Molars



**DE-034**  
**# 73 A**  
lower molars



**DE-035**  
**# 73 S**



**DE-036**  
**# 74**  
Lower Roots



**DE-037**  
**# 74N**  
Lower Roots



**DE-038**  
**# 75**  
Lower Premolars



**DE-039**  
**# 86A**  
Lower Molars



**DE-040**  
**# 86B**  
lower molars



**DE-041**  
**# 86C**  
lower molars



**DE-042**  
**# 87**  
Lower Molars



**DE-043**  
**# 89**  
Upper Molars,  
Right



**DE-044**  
**# 90**  
Upper Molars,  
Left



# EXTRACTING FORCEPS (English Pattern)

- Щипцы экстракционные (английская форма)
- Daviers (Forme Anglaise)
- Zahnzangen (Englische Form)

- Щипці екстракційні (англійська форма)
- Forceps de Extracción (Forme Inglesa)
- استخراج المنقط (نمط اللغة الإنجليزية)

A-TRAUMATIC EXTRACTION  
Improved tapered beaks for complete root contact. Cross serrations.  
Deep Gripe Extracting Forceps



- No Fracture
- No Tissue Damage
- Extraction With Easy



Thin Tip

**DE-045**  
**# 34**  
Upper incisors and  
premolars  
deep-gripping



Wide Tip

**DE-046**  
**# 34A**  
Upper centrals / cains  
deep-gripping



Thin Tip

**DE-047**  
**Fig. 35**  
upper permolars  
deep-gripping



Wide Tip

**DE-048**  
**# 35A**  
Upper incisors and  
premolars  
deep-gripping



Thin Tip

**DE-049**  
**# 36**  
Lower premolars  
deep-gripping



Wide Tip

**DE-050**  
**# 36A**  
Lower premolars  
deep-gripping



**DE-051**  
**# 336**  
lower permolars  
deep-gripping



**DE-052**  
**F-7C**  
lower molar



**DE-053**  
**# 9**  
Apex Forceps Lower Universal  
Deep Root Pick



**DE-054**  
**# 79N**  
Lower third molars  
deep-gripping



**DE-055**  
**# 79**  
Lower Thrid Molars



# EXTRACTING FORCEPS (English Pattern)

- Щипцы экстракционные (английская форма)
- DAVIERS (Forme Anglaise)
- Zahnzangen (Englische Form)
- Щипці екстракційні (англійська форма)
- Forceps de Extracción (Forme Inglesa)
- استخراج المنقط (نمط اللغة الإنجليزية)

## DEEP GRIP FORCEPS



**DE-056**  
**# 146**

Apex Forceps Lower Root  
Deep Root Pick



**DE-057**  
**# 153**

Apex Forceps Upper Root  
Deep Root Pick



**DE-058**  
**# 149**

Apex Forceps Upper Root  
Deep Root Pick



**DE-061**  
**Fig. 44**



**DE-060**  
**Fig. 44Z**



**DE-059**  
**Fig. 45Z**



**DE-062**  
**# 46XL**  
Apex Forceps Lower Root  
Deep Root Pick



**DE-063**  
**# 67**  
Upper Third Molars



**DE-064**  
**# 67A**  
Upper Third Molars



**DE-065**  
**# 67N**  
Lower third molars  
deep-gripping



**DE-066**  
**# 331**  
upper roots  
deep-gripping



## EXTRACTING FORCEPS (English Pattern)

- Щипцы экстракционные (английская форма)
- Daviers (Forme Anglaise)
- Zahnzangen (Englische Form)

- Щипці екстракційні (англійська форма)
- Forceps de Extracción (Forme Inglesa)
- استخراج المنقط (نمط اللغة الإنجليزية)

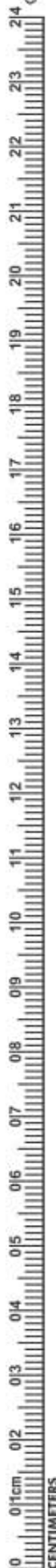

Fig. 1  
upper  
laterals  
and canines



- DE-067** Set of 10 Pieces  
 Fig. 1  
 Fig. 7  
 Fig. 13  
 Fig. 17  
 Fig. 18  
 Fig. 22  
 Fig. 51A  
 Fig. 67  
 Fig. 74N  
 Fig. 79

Fig. 7  
upper  
premolars



Fig. 13  
lower  
premolars



Fig. 17  
upper  
molars,  
right



Fig. 18  
upper  
molars,  
left



Fig. 22  
lower  
roots



Fig. 51A  
upper roots



Fig. 67  
upper third  
molars



Fig. 74N  
lower  
molar



Fig. 79  
lower third  
molars



# EXTRACTING FORCEPS

- Щипцы экстракционные
- Daviers
- Zahnzangen
- Щипці екстракційні
- Forceps de Extracción
- استخراج الملقط

## Pediatric Tooth Extracting Forceps Set



**DE-069**  
English Pattern Klein #51S  
Pedodontic Upper root



**DE-068**  
English Pattern Klein #137  
Pedodontic, Upper Incisors Spring handle



**DE-072**  
English Pattern Klein #5  
Pedodontic Lower Incisors.



**DE-070**  
English Pattern Klein #139  
Pedodontic Upper Premolars

### Baby Tooth Extraction Forceps



Fig. # 01 to 07  
Set of 7 Pieces



**DE-073**  
English Pattern Klein #7  
Pedodontic Lower Roots,



**DE-071**  
English Pattern Klein #3  
Pedodontic Upper Molars Universal

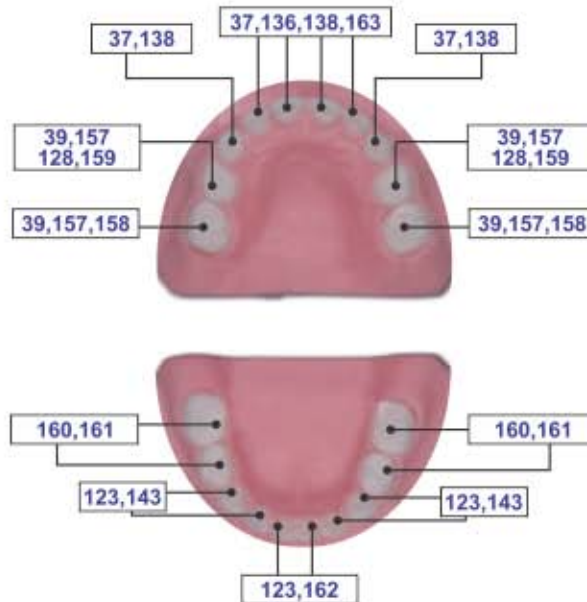

**DE-074**  
English Pattern Klein #6  
Pedodontic Lower Molars, Spring Handle



## EXTRACTING FORCEPS (American Pattern)

- Щипцы экстракционные (американская форма)
- Daviers - forme americane
- Fórceps de extracción - forma americana
- Щипці екстракційні (американська форма)
- Pinzaper per estrazione - forma americana
- استخراج المنقط (النمط الأمريكي)



**DE-075**  
# 1STD  
Winter  
upper centrals and canines



**DE-076**  
Fig. 1  
upper incisors  
and roots



**DE-077**  
Cryer  
Fig. 150



# EXTRACTING FORCEPS (American Pattern)

- Щипцы экстракционные (американская форма)
- Щипці сктракційні (американська форма)
- Daviers - forme américaine
- Pinzere per estrazione - forma americana
- Fôrceps de extracción - forma americana
- استخراج الملقط (النمط الأمريكي)



**DE-078**  
Fig. 150A  
Cryer

upper incisors, premolars, roots



**DE-079**

Fig. 62  
incisors, premolars,  
deciduous teeth



**DE-080**

# 10S  
upper roots



**DE-081**

# 17  
lower molars



**DE-082**  
Harris  
Fig. 18R



**DE-083**  
Harris  
Fig. 18L



## EXTRACTING FORCEPS (American Pattern)

- Щипцы экстракционные (американская форма)
- Daviers - forme américaine
- Fórceps de extracción - forma americana
- Щипці екстракційні (американська форма)
- Pinzere per estrazione - forma americana
- استخراج المنقط (النمط الأمريكي)



**DE-084**  
Fig. 210  
upper third molars



**DE-085**  
Fig. 53R  
upper molars, right



**DE-086**  
Fig. 53L  
upper molars, left



**DE-087**  
NEVIUS  
Fig. 88R

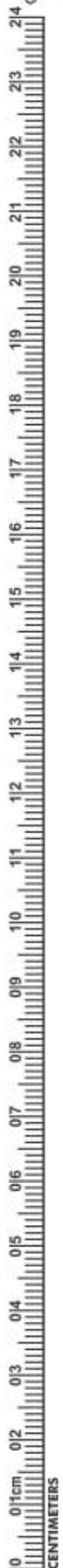

# EXTRACTING FORCEPS (American Pattern)

- Щипцы экстракционные (американская форма)
- Щипці сктракційні (американська форма)
- Daviers - forme américaine
- Pinzereper per estrazione - forma americana
- Fôrceps de extracción - forma americana
- استخراج الملقط (التمط الأمريكي)



**DE-088**  
Fig. 24  
upper molars



**DE-089**  
# 210S  
upper third molars



**DE-090**  
# 210H  
upper third molars



**DE-091**  
# 286  
Upper Roots,  
Premolars, Incisors



**DE-092**  
# 99C  
Kells  
upper incisors,  
canines, premolars



**DE-093**  
# 222  
lower third molars



**DE-094**  
# 286  
Lower Molar



## EXTRACTING FORCEPS (American Pattern)

- Щипцы экстракционные (американская форма)
- Daviers - forme américaine
- Fórceps de extracción - forma americana
- Щипці екстракційні (американська форма)
- Pinzaper per estrazione - forma americana
- استخراج المنقط (النمط الأمريكي)



**DE-095**  
Nevius  
Fig. 88L  
upper molars, left



**DE-096**  
Fig. 65  
upper incisors  
and roots



**DE-097**  
Parmly Fig. 32A  
upper premolars  
and roots



**DE-098**  
Parmly Fig. 32  
upper premolars  
and molars



## EXTRACTING FORCEPS (American Pattern)

- Щипцы экстракционные (американская форма)
- Щипці скстракційні (американська форма)
- Pinzere per estrazione - forma americana
- استخراج الملقط (النمط الأمريكي)
- Daviers - forme américaine
- Fôrceps de extracción - forma americana

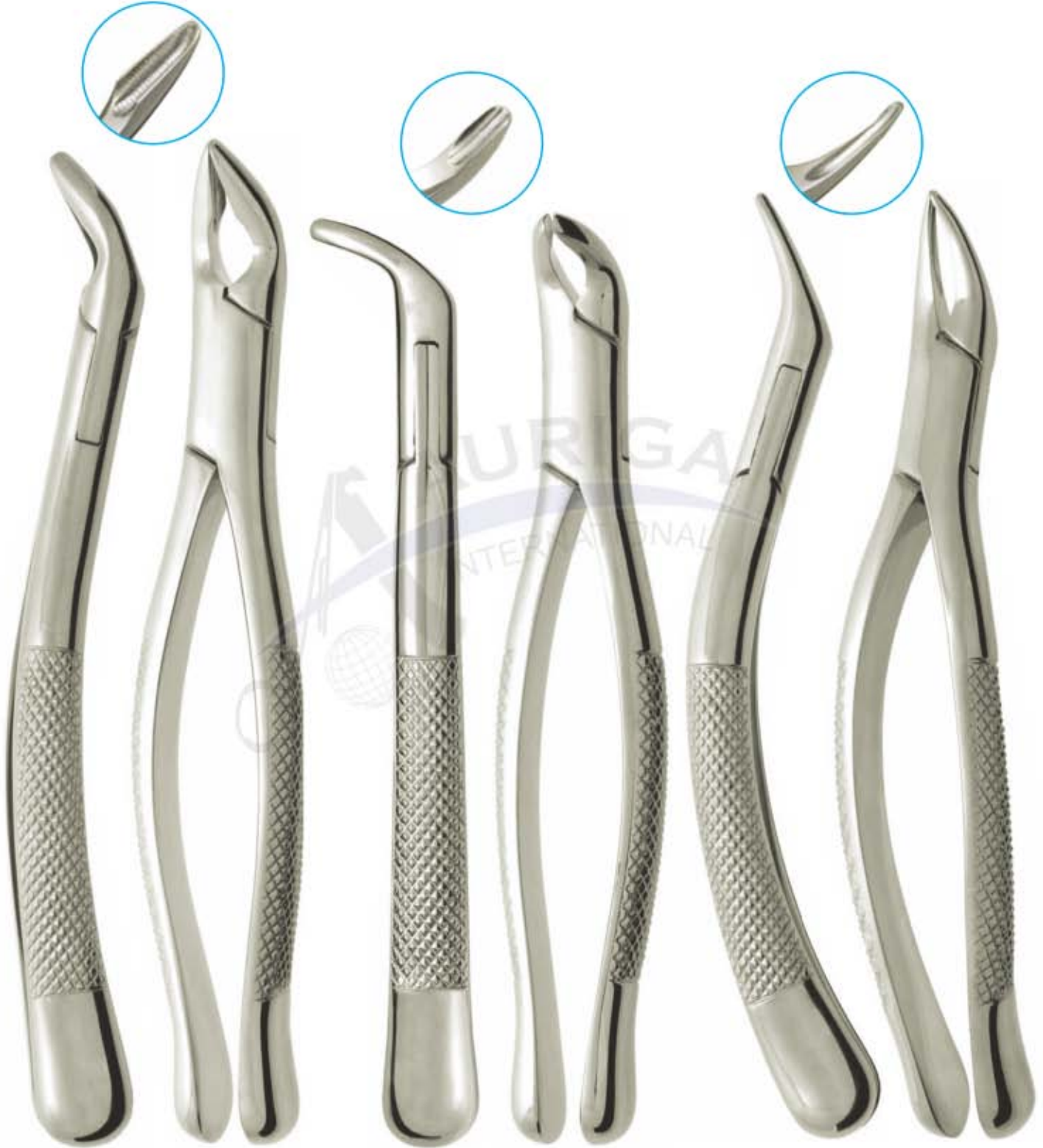

**DE-099**  
COHEN  
universal

**DE-100**  
Fig. 203  
lower incisors  
and roots

**DE-101**  
Tomes Fig. 69  
upper and lower  
roots



## EXTRACTING FORCEPS (American Pattern)

- Щипцы экстракционные (американская форма)
- Daviers - forme américaine
- Fórceps de extracción - forma americana
- Щипці екстракційні (американська форма)
- Pinzere per estrazione - forma americana
- استخراج المنقط (النمط الأمريكي)



**DE-102**  
Fig. 23  
lower molars



**DE-103**  
Fig. 16  
lower molars



**DE-104**  
Physic Fig. 5  
lower third molars



**DE-105**  
Harris Fig. 15  
lower molars



**DE-106**  
Fig. 103



## EXTRACTING FORCEPS (American Pattern)

- Щипцы экстракционные (американская форма)
- Щипці скстракційні (американська форма)
- Pinzere per estrazione - forma americana
- Fôrceps de extracción - forma americana
- استخراج الملقط (التمط الأمريكي)



**DE-107**  
Hull  
Fig. 101  
Deciduous teeth

**DE-108**  
Cryer  
Fig. 150S  
upper teeth,  
for children

**DE-109**  
Fig. 150 AS

## EXTRACTING FORCEPS (American Pattern)

- Щипцы экстракционные (американская форма)
- Daviers - forme américaine
- Fórceps de extracción - forma americana
- Щипці екстракційні (американська форма)
- Pinzere per estrazione - forma americana
- استخراج المنقط (النمط الأمريكي)

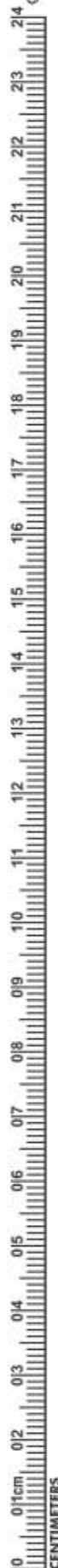

**DE-110**  
Cryer  
Fig. 151  
lower teeth,  
for children

**DE-111**  
Fig. 151 S  
lower incisors,  
premolars, roots

**DE-112**  
Fig. 151 AS

# EXTRACTING FORCEPS (American Pattern)

- Щипцы экстракционные (американская форма)
- Щипці сктракційні (американська форма)
- Pinzere per estrazione - forma americana
- استخراج الملقط (النمط الأمريكي)
- Daviers - forme américaine
- Fôrceps de extracção - forma americana



**DE-113  
# 16S**  
lower molars for children



**DE-114  
# 17S**  
lower molars



**DE-115  
# 23 S**  
Lower molars



**DE-116  
# 27**  
lower molars



**DE-117  
# 18LS**  
upper molars left



**DE-118  
# 18RS**  
upper molars right



**DE-119  
# 85 Tomas**  
lower canines, premolars and molars



**DE-120  
# 85A Tomas**  
lower canines, premolars and molars



**DE-121  
# 69S**  
upper and lower roots



**DE-122  
# 99A Kells**  
upper incisors, canines, premolars



**DE-123  
# 217**  
lower molars



## EXTRACTING FORCEPS (American Pattern)

- Щипцы экстракционные (американская форма)
- Daviers - forme américaine
- Fórceps de extracción - forma americana
- Щипці екстракційні (американська форма)
- Pinzeta per estrazione - forma americana
- استخراج المنقط (النمط الأمريكي)



**DE-124**  
**#10 SK**  
Upper Molars Sup



**DE-125**  
**#17 SK Universal**  
Lower Molars



**DE-126**  
**#23 SK Universal**  
Upper Molars



**DE-127**  
**#69 SK Tomas**  
upper and lower roots



**DE-128**  
**#99 SK**  
upper incisors,  
canines, premolars



**DE-129**  
**#150 SK**  
upper incisors,  
premolars, roots



**DE-130**  
**#151 SK**  
lower incisors,  
premolars, roots



**DE-131**  
**#222 SK**  
lower third molars

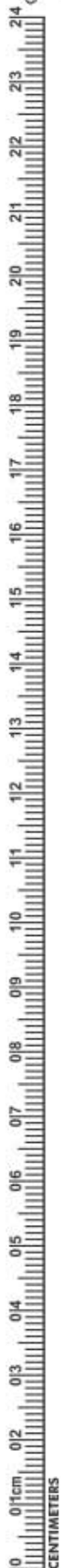

## EXTRACTING FORCEPS (American Pattern)

- Щипцы экстракционные (американская форма)
- Щипці скстракційні (американська форма)
- Pinzere per estrazione - forma americana
- استخراج الملقط (النمط الأمريكي)
- Daviers - forme américaine
- Fôrceps de extracção - forma americana



**DE-132**  
Fig. 1  
Upper Anterior

**DE-133**  
Lower Molar  
Fig. 23 Cow Horn



**DE-134**  
Fig. 74  
Lower Anterior



**DE-135**  
Fig. 88L  
Upper Molar Left



**DE-136**  
Fig. 88R  
Upper Molar Right



**DE-137**  
Fig. 74  
Lower Anterior



**DE-138**  
Fig. 106  
Lower Incisors



**DE-139**  
Fig. 174  
Extra Narrow  
Lower Anterior  
Apical Retention  
Forceps



**DE-140**  
Fig. 859  
Lower Molars  
Roots



- Шприцы стоматологические карпульные
- Seringues à usage dentaire
- Dentalspritzen
- Шприцы стоматологічні карпульні
- Jeringas dentales
- المحاقن الأسنان

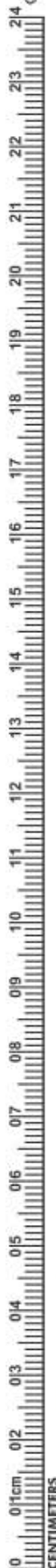

DE-141 1.8ML  
DE-142 2.2ML



DE-143 1.8ML  
DE-144 2.2ML



DE-145 1.8ML  
DE-146 2.2ML



DE-147 1.8ML  
DE-148 2.2ML



DE-149 1.8ML  
DE-149A 2.2ML



DE-149B 1.8ML  
DE-149C 2.2ML



DE-149D  
# 1001  
Intralingamental  
Anesthesia  
Syringe in  
Black Colour



DE-149E 1.8ML  
DE-149F 2.2ML  
Angled



DE-149G  
Aluminium - Dark 1.8 ml

- |   |   |  |                                       |
|---|---|--|---------------------------------------|
|   |   |  |                                       |
| DE-149H<br>Aluminium -<br>Silver 1.8 ml | DE-149I<br>Aluminium -<br>Orange 1.8 ml | DE-149J<br>Aluminium -<br>Green 1.8 ml | DE-149K<br>Aluminium -<br>Blue 1.8 ml |



Type C  
DE1-149 1,8ml.  
DE2-149 2,2ml



Type C  
DE3-149 1,8ml  
DE4-149 2,2ml



2-Ring  
DE5-149 1,8ml.  
DE6-149 2,2ml



Aspirating Syringe  
DE7-149 1.8mm  
DE8-149 2.2mm



Cartridge Syringe  
DE9-149 1.8mm  
DE10-149 2.2mm



Cartridge Syringe  
DE11-149 1.8mm  
DE12-149 2.2mm



Cartridge Syringe  
DE13-149 1.8mm  
DE14-149 2.2mm

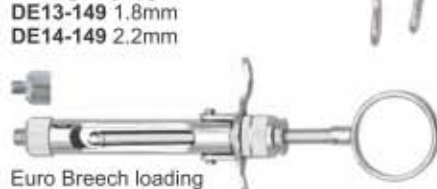

Euro Breech loading  
DE15-149 1.8ml  
DE16-149 2.2ml

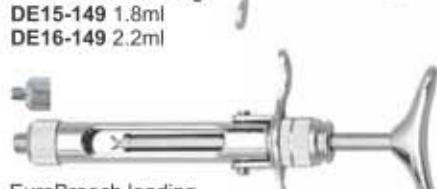

EuroBreech loading  
DE17-149 1.8ml  
DE18-149 2.2ml



Manual Aspirating Syringe  
DE19-149 1.8ml  
DE20-149 2.2ml

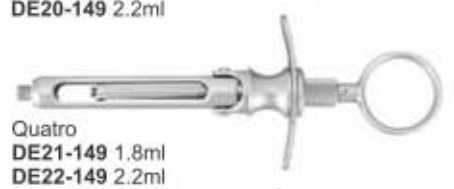

Quatro  
DE21-149 1.8ml  
DE22-149 2.2ml

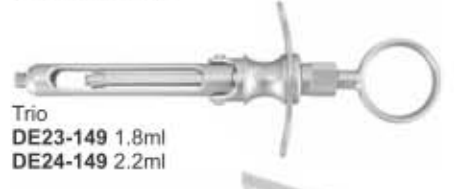

Trio  
DE23-149 1.8ml  
DE24-149 2.2ml



Swedish Type  
DE25-149 1.8ml  
DE26-149 2.2ml



Ject Ultima  
DE27-149 1.8ml  
DE28-149 2.2ml  
Injects 0.05 ml with every click Supplied with  
angled and straight tubes

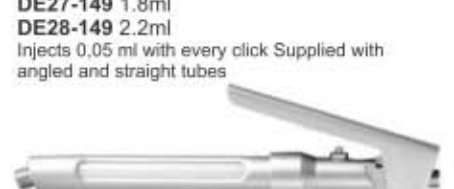

Ject angled  
DE29-149 1.8ml  
DE30-149 2.2ml



Ject Straight  
DE31-149 1.8ml  
DE32-149 2.2ml



Disc System  
DE33-149 1.8ml  
DE34-149 2.2ml



Disc System  
DE35-149 1.8ml

# BONE ROUNGER

- Костные кусачки
- Hohlmeißelzangen
- Pincès-gouges
- Кусачки для кісток
- Pinzas-gubias
- روتچيورس العظام



**DE-149L**  
Blumenthal  
15cm



**DE-149M**  
Blumenthal  
15cm



**DE-149N**  
Blumenthal  
15cm



**DE-149O**  
Friedman  
14cm



**DE-149P**  
Friedman  
14.5cm



**DE-149Q**  
Micro-Friedman  
14cm



**DE-149R**  
Micro-Friedman  
15cm



**DE-149S**  
Micro-Friedman  
16cm



**DE-149T**  
Kleinert-Kutz  
18.5cm



**DE-149U**  
Beyer  
18.5cm



**DE-149V**  
Mead 1A  
18.5cm



**DE-149W**  
Luer  
18.5cm



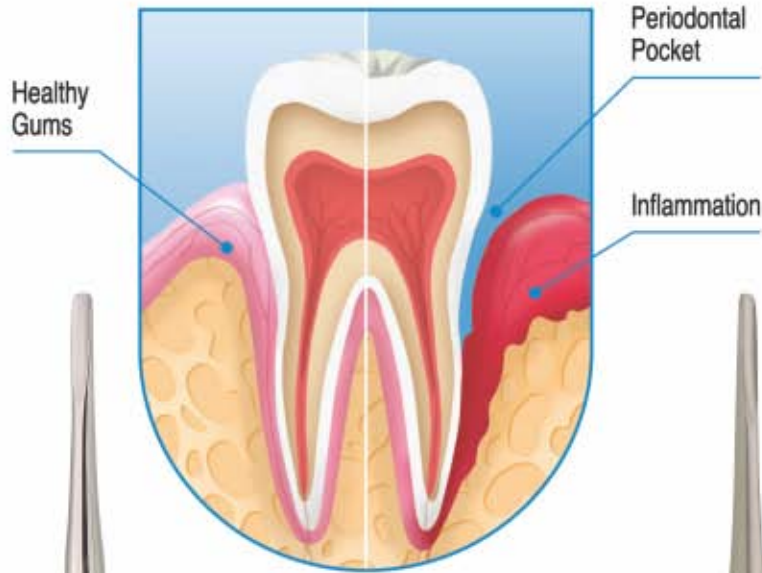
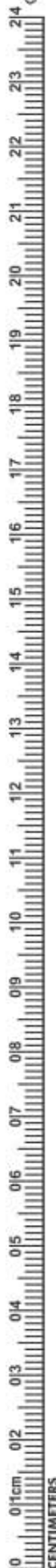

HANDLES FOR ROOT ELEVATORS POINTS  
A, B, C, D

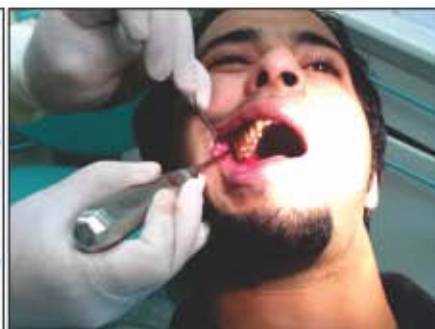
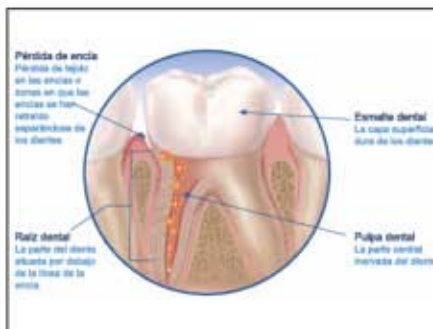

# ROOT ELEVATOR

- Элеватор корневой экстракционный
- Elévateurs à racines
- Wurzelheber
- Слеватор корневий экстракційний
- Elevadores para raices
- المعاعد الجذر

## Apexo Root Elevators



Apexo



**DE-150**  
Apexo  
2.5x9mm  
Straight



**DE-151**  
Apexo  
2.7x9mm  
Straight



**DE-152**  
Apexo  
3.0x9mm  
Straight



**DE-153**  
Apexo  
2.5x9mm  
Curved



**DE-154**  
Apexo  
3.0x9mm  
Curved



**DE-155**  
Seldin  
3.0x14mm  
Straight

## Luxator Root Elevators



Luxator



**DE-156**  
Luxator  
3mm  
straight



**DE-157**  
Luxator  
3mm  
curved



**DE-158**  
Luxator  
4mm  
straight



**DE-159**  
Luxator  
4mm  
curved



**DE-160**  
Luxator  
5mm  
straight



**DE-161**  
Luxator  
5mm  
curved

## Bein Root Elevators



Bein



**DE-162**  
Bein 2mm



**DE-163**  
Bein 3mm



**DE-164**  
Bein 4mm

## Seldin Root Elevators



Seldin



**DE-165**  
Floh 1



**DE-166**  
Seldin 34S



**DE-167**  
Seldin 34



- Элеватор корневой экстракционный
- Elévateurs à racines
- Wurzelheber
- Слеватор корневий екстракційний
- Elevadores para raices
- المصاعد الجذر

## Apexo Root Elevators



Apexo



**DE-168**  
Apexo  
2.5x9mm  
Straight



**DE-169**  
Apexo  
2.7x9mm  
Straight



**DE-170**  
Apexo  
3.0x9mm  
Straight



**DE-171**  
Apexo  
2.5x9mm  
Curved



**DE-172**  
Apexo  
3.0x9mm  
Curved



**DE-173**  
Seldin  
3.0x14mm  
Straight

## Luxator Root Elevators



Luxator



**DE-174**  
Luxator  
3mm  
straight



**DE-175**  
Luxator  
3mm  
curved



**DE-176**  
Luxator  
4mm  
straight



**DE-177**  
Luxator  
4mm  
curved



**DE-178**  
Luxator  
5mm  
straight



**DE-179**  
Luxator  
5mm  
curved

## Bein Root Elevators



Bein



**DE-180**  
Bein 2mm



**DE-181**  
Bein 3mm



**DE-182**  
Bein 4mm

## Seldin Root Elevators



Seldin



**DE-183**  
Flohr 1



**DE-184**  
Seldin 34S



**DE-185**  
Seldin 34

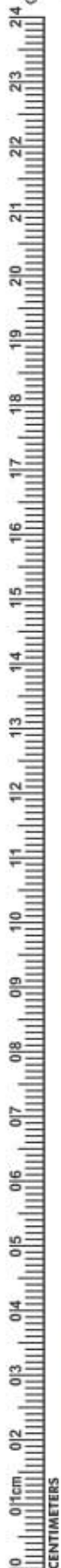

# ROOT ELEVATOR

- Элеватор корневой экстракционный
- Elévateurs à racines
- Wurzelheber
- Слеватор корневий экстракційний
- Elevadores para raices
- المعاصر الجذر

## Apical Root Elevators

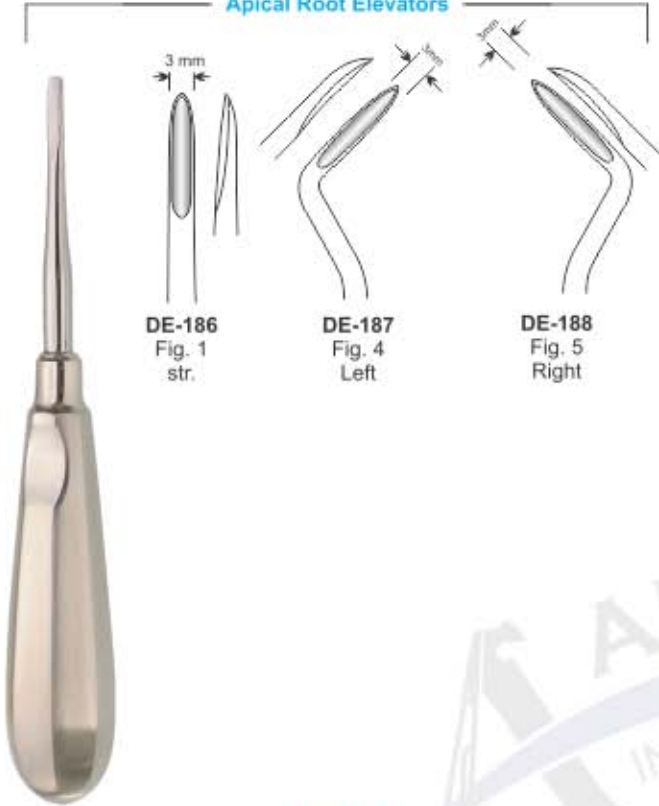

## Apical Root Elevators

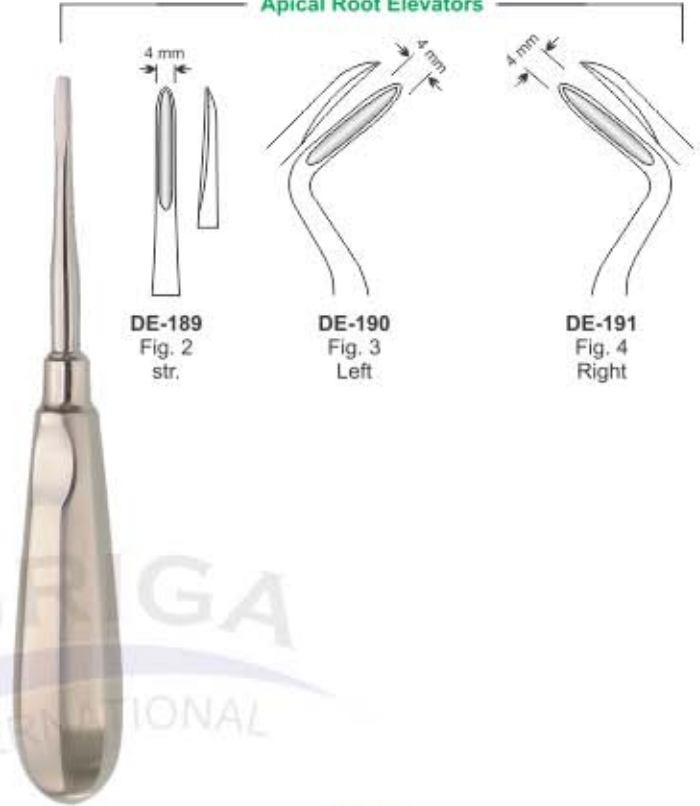

## Coupland Root Elevators

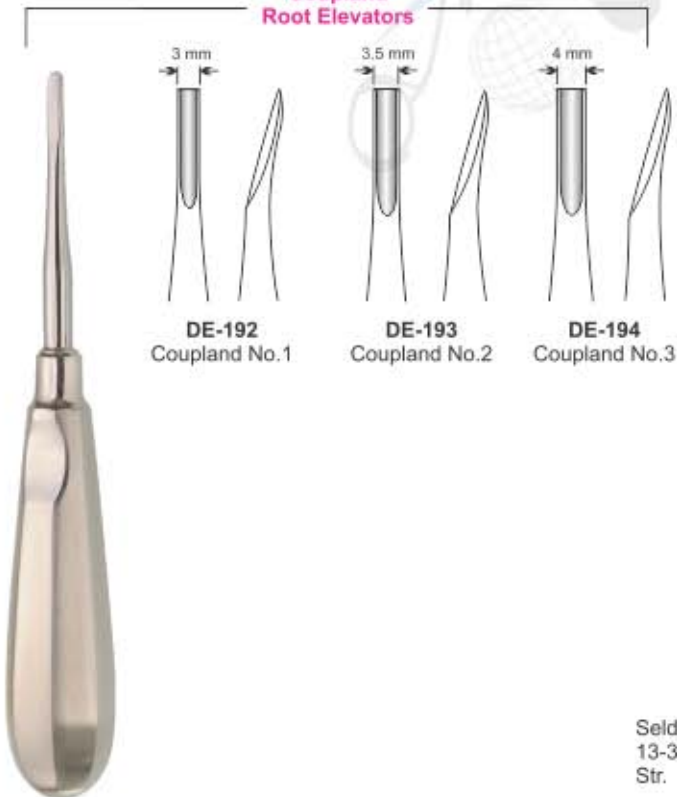

## Seldin Root Elevators

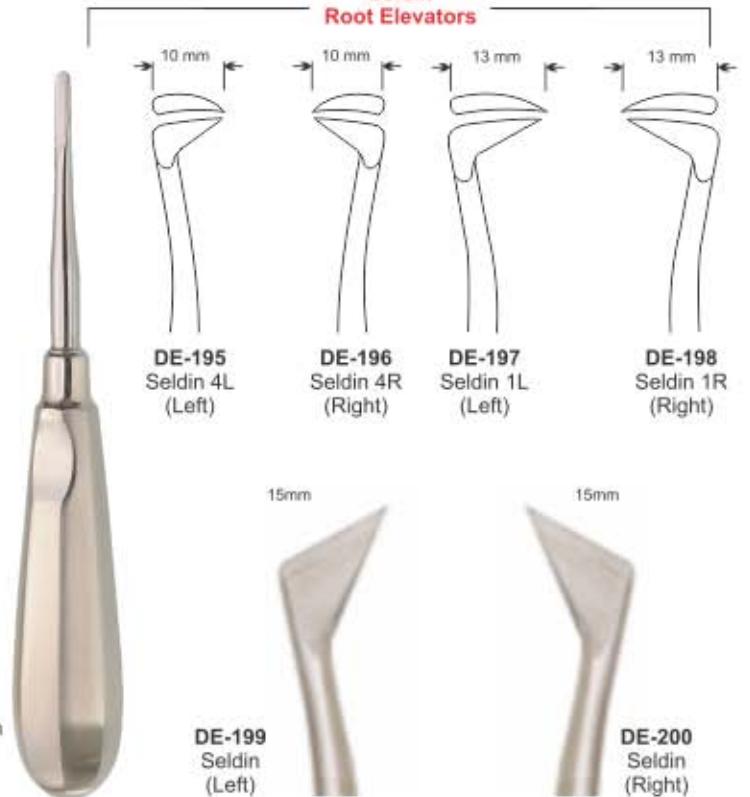

- Элеватор корневой экстракционный
- Elévateurs à racines
- Wurzelheber

- Слеватор корневий екстракційний
- Elevadores para raices
- المصاعد الجذر

**Apical Root Elevators**

**Apical Root Elevators**

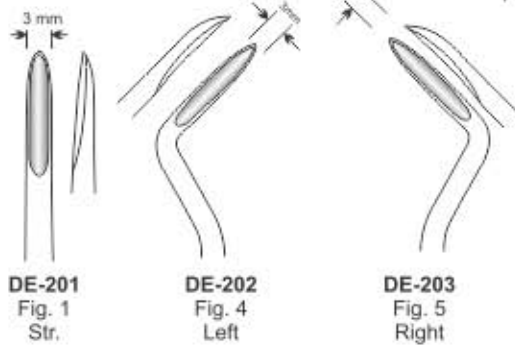

**DE-201**  
Fig. 1  
Str.

**DE-202**  
Fig. 4  
Left

**DE-203**  
Fig. 5  
Right

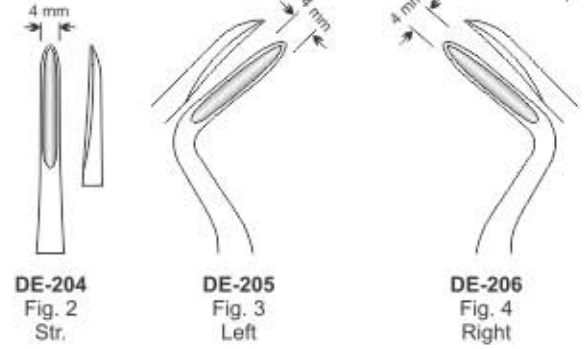

**DE-204**  
Fig. 2  
Str.

**DE-205**  
Fig. 3  
Left

**DE-206**  
Fig. 4  
Right

**Coupland Root Elevators**

**Seldin Root Elevators**

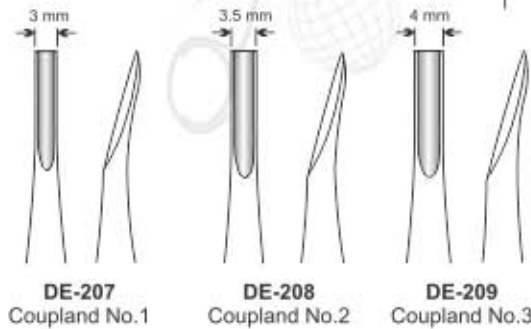

**DE-207**  
Coupland No.1

**DE-208**  
Coupland No.2

**DE-209**  
Coupland No.3

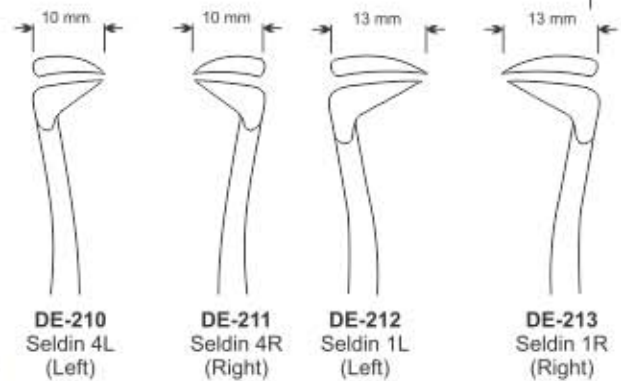

**DE-210**  
Seldin 4L  
(Left)

**DE-211**  
Seldin 4R  
(Right)

**DE-212**  
Seldin 1L  
(Left)

**DE-213**  
Seldin 1R  
(Right)

Coupland

Seldin  
13-3  
Str.



**DE-214**  
Seldin  
(Left)



**DE-215**  
Seldin  
(Right)



# ROOT ELEVATOR

- Элеватор корневой экстракционный
- Elévateurs à racines
- Wurzelheber
- Слеватор корневий екстракційний
- Elevadores para raices
- المعاصر الجذر

## Apical Root Elevators

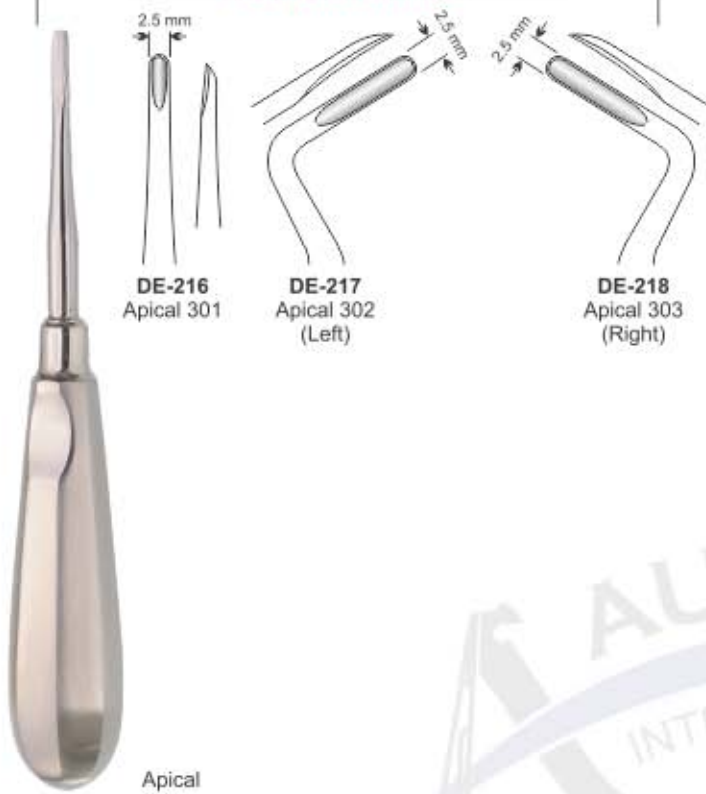

## Apical Root Elevators



## Apical Root Elevators



## Laxutor Root Elevators

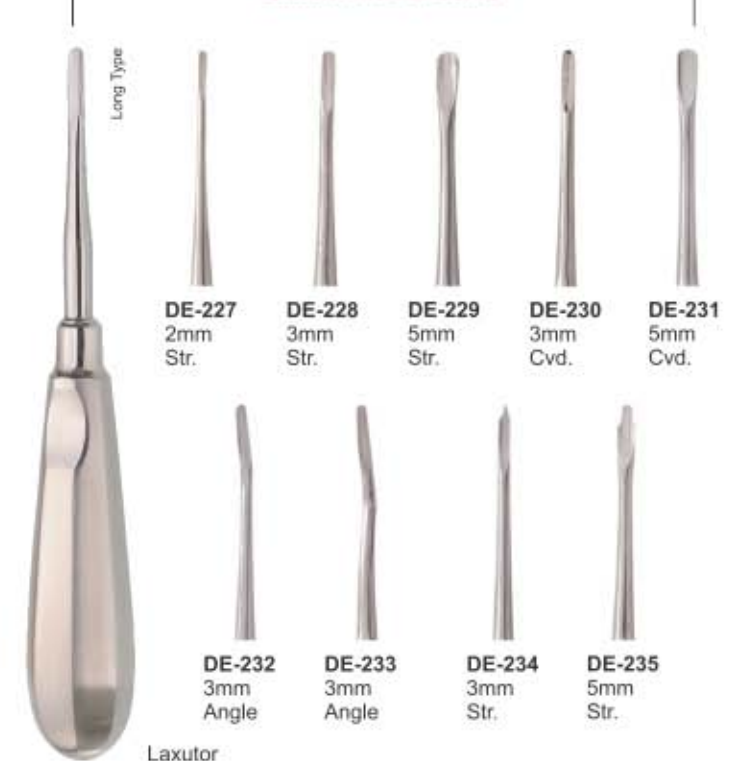

- Элеватор корневой экстракционный
- Elévateurs à racines
- Wurzelheber
- Слеватор корневий екстракційний
- Elevadores para raices
- المصاعد الجذر

## Lindo Levian Root Elevators



## Flohr Root Elevators



## Heidbrink Root Elevators

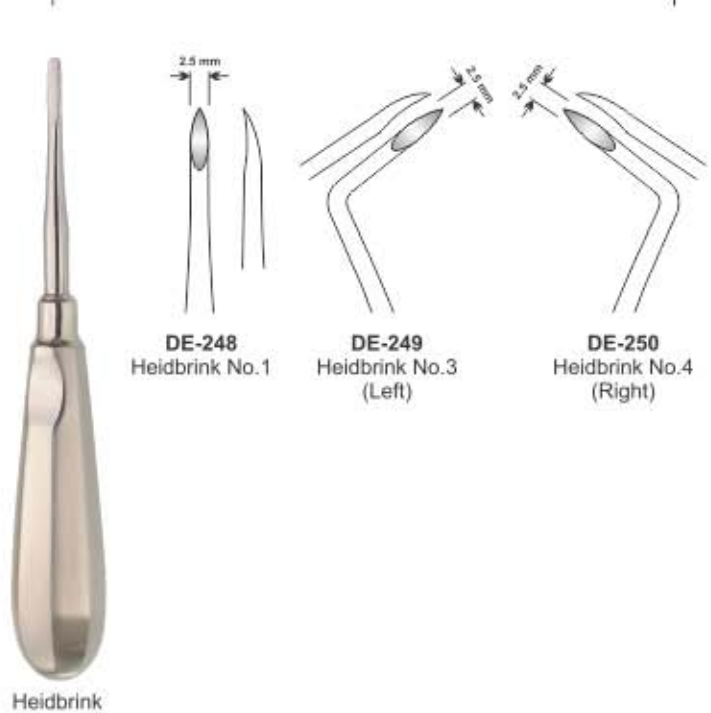

# ROOT ELEVATOR

- Элеватор корневой экстракционный
- Elévateurs à racines
- Wurzelheber
- Слеватор корневий екстракційний
- Elevadores para raices
- المعاعد الجذر

## Friedmann Roots Elevator



DE-251 Friedmann 4F Str.  
DE-252 Friedmann 5F Left  
DE-253 Friedmann 6F Right

## Heidbrink Roots Elevator



DE-254 Heidbrink Straight  
DE-255 Heidbrink Left  
DE-256 Heidbrink Right

## Wisdom Roots Elevator



DE-257 Wisdom for 18 and 38  
DE-258 Wisdom for 28 and 48

## Bayonet Roots Elevator Set



DE-259 Left  
DE-260 Right  
DE-261 bayonet  
DE-262 Curved  
DE-263 Straight

## Luxator Roots Elevator



DE-264 Luxator Straight  
DE-265 Luxator Curved



- Элеватор корневой экстракционный
- Elévateurs à racines
- Wurzelheber
- Слеватор корневий екстракційний
- Elevadores para raices
- المصاعد الجذر

**Roots Elevator**



**Luxier Roots Elevator**



**Luxier Roots Elevator**



**Claw-Lift Roots Elevator**

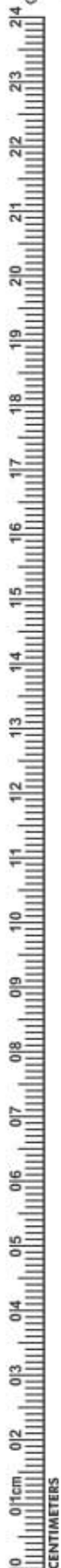

# ROOT ELEVATOR

- Элеватор корневой экстракционный
- Elévateurs à racines
- Wurzelheber
- Слеватор корневий экстракційний
- Elevadores para raices
- المعساعد الجذر

## Hysin Roots Elevator



## Cryer Roots Elevator



## Kopp Roots Elevator



- Элеватор корневой экстракционный
- Elévateurs à racines
- Wurzelheber

- Слеватор корневий екстракційний
- Elevadores para raices
- المصاعد الجذر

**Kopp Roots Elevator**



**DE-295**  
Kopp  
Right

**DE-296**  
Kopp  
Left

**Heber Roots Elevator**



**DE-297**  
Heber  
Bayonet

**DE-298**  
Heber  
Bayonet

**Bein Roots Elevator**



**DE-299**  
Bein,  
3mm

**DE-300**  
Bein,  
4mm

**Bein Roots Elevator**



**DE-301**  
Bein  
2mm, curved  
serrated



**DE-302**  
2mm  
straight  
serrated



**DE-303**  
3mm  
straight



**DE-304**  
4mm  
Curved



**DE-305**  
Bein  
2mm, curved  
serrated



**DE-306**  
2mm  
straight  
serrated



**DE-307**  
3mm  
straight



**DE-308**  
4mm  
Curved



**DE-309**  
Bein  
2mm, curved  
serrated



**DE-310**  
2mm  
straight  
serrated



**DE-311**  
3mm  
straight



**DE-312**  
4mm  
Curved

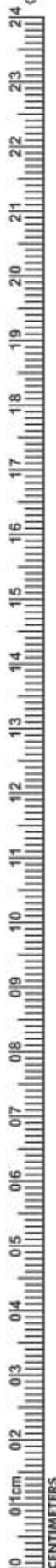

# ROOT ELEVATOR

- Элеватор корневой экстракционный
- Elévateurs à racines
- Wurzelheber
- Слеватор корневий экстракційний
- Elevadores para raices
- المصاعد الجذر

## Seldin Roots Elevator



## W. Barry Roots Elevator



## Winter Roots Elevator



## Pott Roots Elevator



- Элеватор корневой экстракционный
- Elévateurs à racines
- Wurzelheber

- Слеватор корневий экстракційний
- Elevadores para raices
- المصاعد الجذر

**Heidbrink Roots Elevator**



**DE-338**  
Heidbrink  
Straight

**DE-339**  
Heidbrink  
Left

**DE-340**  
Heidbrink  
Right

**DE-341**  
Heidbrink  
Straight

**DE-342**  
Heidbrink  
Left

**DE-343**  
Heidbrink  
Right

**Syndesmotomes Roots Elevator**



**DE-344**  
Straight

**DE-345**  
Left

**DE-346**  
Right

**Periotome Roots Elevator**



**DE-347**  
Periotome  
2.1mm  
Straight

**DE-348**  
Periotome  
2.6mm  
Straight

**DE-349**  
Periotome  
2.1mm  
Angular

**DE-350**  
Periotome  
2mm  
Curved

**DE-351**  
Periotome  
2.0mm

**DE-352**  
Periotome  
2.5mm

**DE-353**  
Periotome  
3.0mm

**DE-354**  
Periotome  
4.0mm

Syndesmotomes

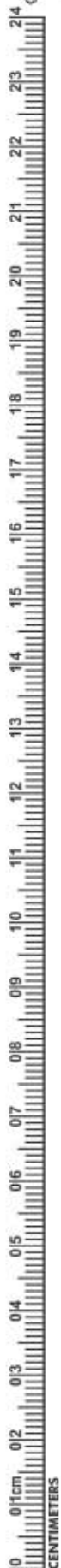

# ROOT ELEVATOR

- Элеватор корневой экстракционный
- Elévateurs à racines
- Wurzelheber
- Слеватор корневий екстракційний
- Elevadores para raices
- المصاعد الجذر



**DE-355**  
1S  
(Straight 1mm)



**DE-356**  
2S  
(Straight 2mm)



**DE-357**  
3S  
(Straight 3mm)



**DE-358**  
5S  
(Straight 5mm)



**DE-359**  
3C  
(Curved 3mm)



**DE-360**  
5C  
(Curved 5mm)



**DE-361**  
3CA  
(Curved Angle 3mm)



**DE-362**  
3IC  
(Inverted Curved 3mm)



**DE-363**  
DE 3  
(Dual Edge 3mm / 1.5mm)



**DE-364**  
DE 5  
(Dual Edge 5mm / 3mm)



- Элеватор корневой экстракционный
  - **Elévateurs à racines**
  - Wurzelheber
- PDL ELEVATORS**

- Слеватор корневий екстракційний
- Elevadores para raíces
- المصاعد الجذر

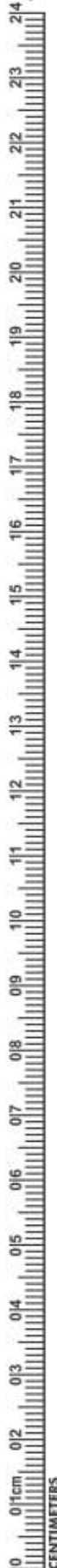

**DE-365**  
PDL Elevators  
Set of 7 Pcs



**DE-366**  
PDL Elevators  
Set of 7 Pcs

# ROOT ELEVATOR

- Элеватор корневой экстракционный
- Elévateurs à racines
- Wurzelheber
- Слеватор корневий екстракційний
- Elevadores para raices
- المعاعد الجذر

## PDL ELEVATORS

Delicate Arrow tip



4,0mm straight  
4,0mm curved

Luxivators straight  
atraumatic luxation of the tooth



2,5mm straight  
3,5mm straight  
4,5mm straight

Luxivators curved  
atraumatic luxation of the tooth



2,5mm curved  
3,5mm curved  
4,5mm curved



DE-367  
PDL Elevators  
Set of 8 Pcs



## Our Scalers

Compare our scalers and curettes with the best in the industry and you will immediately recognize we are equal in every way but one... price. Note the deep precision knurling for better tactile feel. The same high-grade stainless steel tips, the same light weight (under 18 grams) for less hand fatigue, the same professional craftsmanship, and surpassing the highest industry standards. of course, any manufacturer can make these claims, but we guarantee and certify ours.

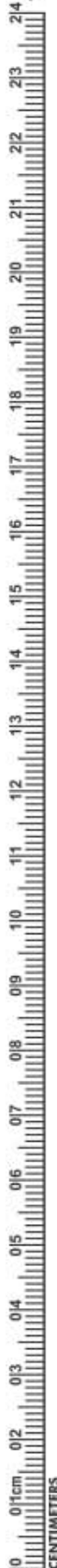

Healthy

Periodontal Disease

Healthy Gums

Healthy Attachment and Bone Levels

Periodontal Prob

Plaque Bacteria Biofilm

Calculus / Tartar

Periodontal Pocke

Reduced Attachmen and Bone Level

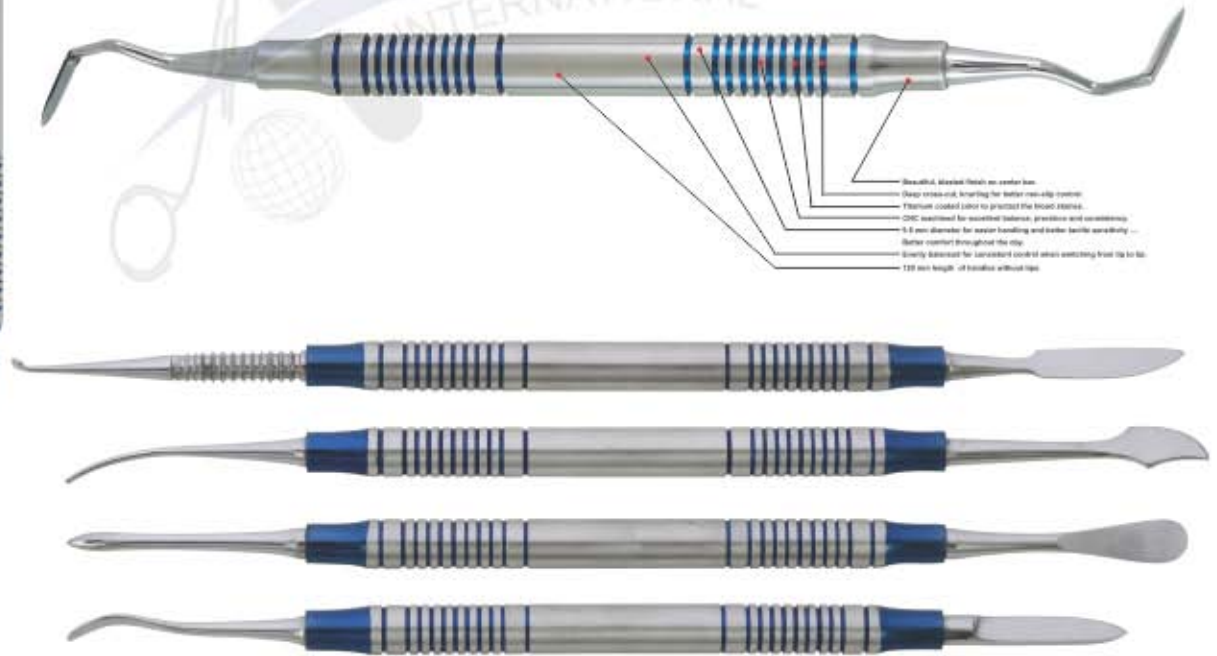

- Smooth, mirror finish on working face
- Deep cross-hatch knurling for better non-slip control
- Titanium coated color to protect the hand zones
- CNC machined for excellent balance, precision and consistency
- 1.5 mm diameter for easier handling and better tactile sensitivity
- Better control throughout the site
- Evenly balanced for consistent control when working from tip to base
- 120 mm length of handle without tips

- High-polish mirror finish tips.
- Manufactured within the guidelines of the FDA quality assurance system for good manufacturing practices.
- Highest grade German stainless steel, razor sharp, durable tips. Rockwell hardened to 60 RHc.
- 27 of the most popular designs from graceys to McCalls to cumbias, and many european patterns.
- All instruments are guaranteed against defects in material and workmanship.

- All instruments bear the ce mark, emblematic of the european community's highest standards.
- Customer satisfaction guarantee, too!
- Less than 20 grams ... Lightweight for less hand fatigue.
- Manufactured to the most exacting standards so the 50th instrument you buy is exactly like your first.
- You decide ... Why pay more for the same high-quality instruments?

# HANDLES FOR MOUTH MIRRORS

- Ручки для зеркал
- Manches pour miroirs à bouche
- Mundspiegelgriffe
- Ручки для дзеркал
- Mangos para espejos de boca
- مقابض لمرآيا الفم

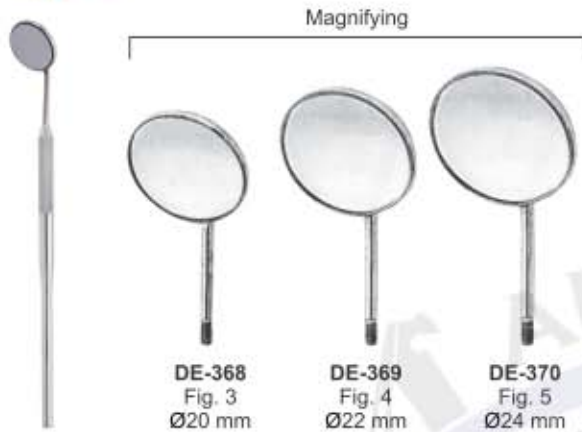

- Пинцеты
- Pinçettes - Brucelles
- Zahnpinzetten

- Пинцети
- Pinzas para algodón
- ملاقط



**DE-381**  
Surgical  
11.5cm



**DE-382**  
London College  
15cm



**DE-383**  
Semken Taylor  
Str.



**DE-384**  
Semken Taylor  
Cvd.



**DE-385**  
Meriam  
16cm



**DE-386**  
Dressing  
14cm



**DE-387**  
Semken Taylor  
1x2 Straight



**DE-388**  
Semken Taylor  
1x2 Curved



**DE-389**  
Gilles  
15cm 1x2



**DE-390**  
14cm 1x2



**DE-391**  
Perry  
13cm



**DE-392**  
Atraumatic  
15cm Cvd



**DE-393**  
Atraumatic  
15cm Str.



**DE-394**  
College with Lock  
15cm Cvd.



**DE-395**  
Gerald  
17.5cm



**DE-396**  
with lock  
15cm



**DE-397**  
Atraumatic  
17.5cm

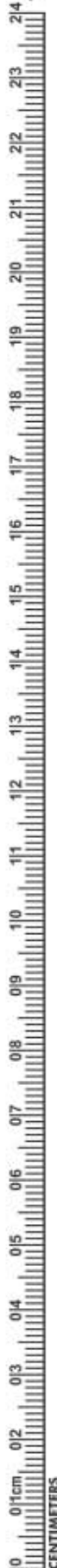

# TWEEZERS

- Пинцеты
- Précelles - Brucelles
- Zahnpinzetten

- Пинцети
- Pinzas para algodón
- זכוכ



**DE-398**  
Adson-TC  
12cm



**DE-399**  
Adson-TC  
12cm 1x2



**DE-400**  
Adson-TC  
15cm 1x2



**DE-401**  
Adson  
12cm



**DE-402**  
Adson  
12cm 1x2



**DE-403**  
Adson  
15cm 1x2



**DE-404**  
Adson Brown  
12cm



**DE-405**  
Crane Kaplan  
15cm



**DE-406**  
Crane Kaplan  
15cm



**DE-407**  
Crane Kaplan  
15cm



**DE-408**  
Hemingway  
15cm



**DE-409**  
Miller  
15cm Str.



**DE-410**  
Miller  
15cm Cvd.



**DE-411**  
Dressing  
Tweezer  
14.5cm



**DE-412**  
College  
Curved  
Tip 15cm



**DE-413**  
Maryam  
Tweezers  
15cm



**DE-414**  
College  
Tweezer  
15cm



**DE-415**  
Perry  
Tweezer  
12.5cm



**DE-416**  
Self-locking  
Tweezer  
15cm



- Зонды
- Sondes
- Zahnsonden
- Зонди
- Sondas
- المستكشفين

Single Ended Probe Solid Handle 4.5mm Length 150mm

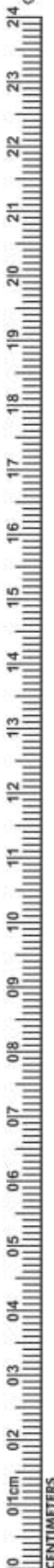

Fig. 2  
Normal Handle



DE-416  
Fig. 2



DE-417  
Fig. 23



DE-418  
Fig. 9



DE-419  
Fig. 16



DE-420  
Fig. 11



DE-421  
Fig. 03



DE-422  
Fig. 3A



DE-423  
Fig. 5



DE-424  
Fig. 6



DE-425  
Fig. 8A



DE-426  
Fig. 10



DE-427  
Fig. 12



DE-428  
Fig. 17



DE-429  
Fig. 17A

Single Ended Probe Hollow Handle 8.5mm Length 150mm



Fig. 2  
Anatomic Handle



DE-430  
Fig. 2



DE-431  
Fig. 23



DE-432  
Fig. 9



DE-433  
Fig. 16



DE-434  
Fig. 11



DE-435  
Fig. 03



DE-436  
Fig. 3A



DE-437  
Fig. 5



DE-438  
Fig. 6



DE-439  
Fig. 8



DE-440  
Fig. 8A



DE-441  
Fig. 10



DE-442  
Fig. 12



DE-443  
Fig. 17



DE-444  
Fig. 17A

# EXPLORERS

- Зонды
- Sondes
- Zahnsonden
- Зонди
- Sondas
- المستكشفين

Probes Single End Solid Handle 6mm, length 150mm



DE-445 Fig. 6    DE-446 Fig. 8    DE-447 Fig. 9    DE-448 Fig. 16    DE-449 Fig. 23

Probes Single Ended 6mm, length 150mm



DE-450 Perio Probe Williams    DE-451 Perio Probe WHO    DE-452 Perio Probe 11    DE-453 Perio Probe 12

Examination kit Set of 3 Pieces



DE-454 Probe    DE-455 Mirror    DE-456 College Forcep 15cm

Examination Set of 4 Pieces



Examination Set of 4 Pieces



DE-457 Exp,23/17-A    DE-458 Exavators    DE-459 Tweezers    DE-460 Mouth Mirror



## EXPLORERS INSTRUMENTS SOLID HANDLE 6MM, LENGTH 170MM

- Зонды
- Зонди
- Sondes
- Sondas
- Zahnsonden
- المستكشفين



Explorers-Single-End

**DE-461**  
23  
Shepherd's  
Hook  
Explorer  
#30, #6, #7, #8

Double-Ended Explorers

Tip Size: 1/1

Solid Handle Size 4.25"

**DE-462**  
#5, #6  
Explorer

**DE-463**  
TU 17/23  
Wilkins/Tufts  
Explorer  
#6

**DE-464**  
23/UNC1  
university of north  
carolina  
Explorer #31, #6, #7, #8

**DE-465**  
1  
#31, #6

**DE-466**  
DG 16  
#31, #6, #7  
Thick, #6

**DE-467**  
DG 16/23

**DE-468**  
DG 16/17

**DE-469**  
1  
Abou-Rass  
Explorers

Probes Double Ended 6mm, length 170mm

**DE-470**  
Goldman Fox  
Fig.17

**DE-471**  
University  
of Michigan  
Fig.17

**DE-472**  
Williams  
Fig.17

**DE-473**  
Goldman Fox  
Fig.16

**DE-474**  
University  
of Michigan  
Fig.16

**DE-475**  
Williams  
Fig.16

# EXPLORERS

- Зонды
- Sondes
- Zahnsonden
- Зонди
- Sondas
- المستكشفين

## Pointed Probes Single Ended Handle 6mm, length 150mm



## Pointed Probes Double Ended Handle 6mm, length 170mm



- Инструменты пародонтологические
- Instruments pour la parodontologie
- Instrumente für die Parodontologie
- Инструменти пародонтологічні
- instrumentos para periodoncia
- الصوك اللثة

## PERIODONTAL SET OF 10 PIECES SOLID HANDLE 6MM LENGTH 170MM

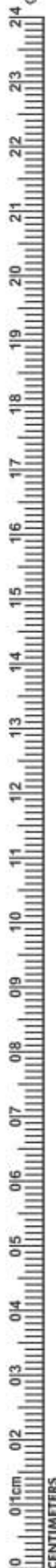

DE-488 MOUTH MIRROR



DE-489 EXP,23/17-A



DE-490 EXAVATORS



DE-491 Filling Instruments



DE-492 EXP,23/CP-18



DE-493 EXP,23/CP-QW



DE-494 EXP,23/CP-11



DE-495 EXP,23/CP-10



DE-496 EXP,23/CP-12



DE-497 EXP,23/CP-11.5-B

# EXPLORERS

- Зонды
- Sondes
- Zahnsonden
- Зонди
- Sondas
- المستكشفين

WILLIAM PROBE SET DOUBLE ENDED WITH HOLLOW HANDLE 9.5MM, LENGTH 170MM  
 CERAMIC COATED HANDLE

Proper care must be given during cleaning, sharpening and sterilization to preserve design and integrity and to prolong usefulness. Do not expose instruments to sterilization temperatures above 350 F/177 C or to higher than recommended chemical concentrations.

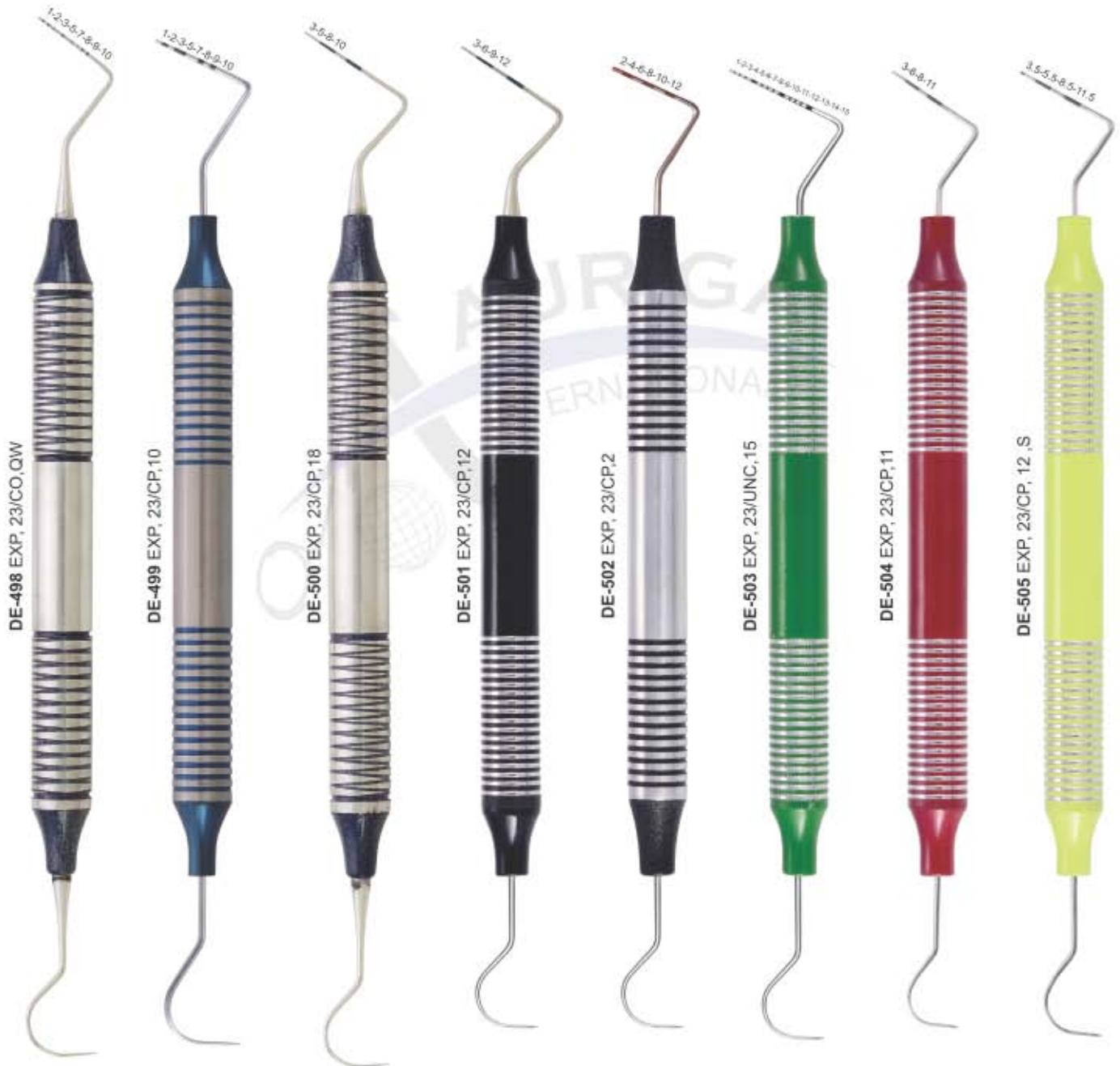

- Инструменты пародонтологические
- Instruments pour la parodontologie
- Instrumente für die Parodontologie

- Інструменти пародонтологічні
- instrumentos para periodoncia
- الصكوك اللثة

**PERIODONTAL INSTRUMENTS SET OF 11 PCS  
SOLID HANDLE 6MM, LENGTH 170MM**



DE-506 Tweezer 125mm

125MM



DE-507 Dental Mirror



DE-508 Excavator



DE-509 Heidmann



DE-510 Gracey



DE-511 Filling Ins



DE-512 Hollanback



DE-513 Plugger



DE-514 Sickle



DE-515 Explorer



DE-516 Cutting Ins

# CURETTES

- Кюрети
- Curetas
- Küretten
- Кюрети
- Curette
- کرتس

**GRACEY SET OF 7 PCS HOLLOW HANDLE 9.5MM, LENGTH 170MM**



**DE-517**  
GRACEY  
1/2

**DE-518**  
GRACEY  
3/4

**DE-519**  
GRACEY  
5/6

**DE-520**  
GRACEY  
7/8

**DE-521**  
GRACEY  
9/10

**DE-522**  
GRACEY  
11/12

**DE-523**  
GRACEY  
13/14



- Кюрети
  - Curetas
  - Küretten
- Кюрети
  - Curette
  - کرتس

**GRACEY SET OF 7 PCS**  
**HOLLOW HANDLE 9.5MM, LENGTH 170MM WITH SILICON GRIP**

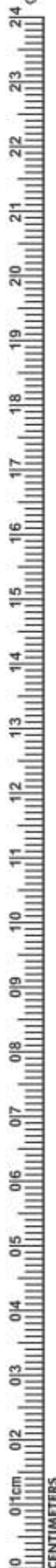

**DE-524**  
GRACEY  
1/2

**DE-525**  
GRACEY  
3/4

**DE-526**  
GRACEY  
5/6

**DE-527**  
GRACEY  
7/8

**DE-528**  
GRACEY  
9/10

**DE-529**  
GRACEY  
11/12

**DE-530**  
GRACEY  
13/14

# CURETTES

- Кюрети
- Curetas
- Küretten
- Кюрети
- Curette
- كرتس

## GRACEY MINI FIVE

HOLLOW HANDLE 9.5MM, LENGTH 170MM  
CERAMIC COATED HANDLE



DE-531	DE-532	DE-533	DE-534	DE-535	DE-536
Gracey	Gracey	Gracey	Gracey	Gracey	Gracey
1/2	3/4	5/6	7/8	11/12	13/14

## GRACEY AFTER FIVE

HOLLOW HANDLE 9.5MM, LENGTH 170MM  
CERAMIC COATED HANDLE



DE-537	DE-538	DE-539	DE-540	DE-541	DE-542
Gracey	Gracey	Gracey	Gracey	Gracey	Gracey
1/2 AF	3/4 AF	5/6 AF	7/8 AF	11/12 AF	13/14 AF

Proper care must be given during cleaning, sharpening and sterilization to preserve design and integrity and to prolong usefulness. Do not expose instruments to sterilization temperatures above 350 F/177 C or to higher than recommended chemical concentrations.



- Кюрети
- Curetas
- Küretten
- Кюрети
- Curette
- کرتس

**GRACEY CURETTE  
HOLLOW HANDLE 10MM, LENGTH 170MM**

Curetters Set of 8 Pieces



**DE-543**  
Curette  
Columbia  
2L-2R

**DE-544**  
Curette  
Columbia  
4L-4R

**DE-545**  
Curette  
McCall  
13S-14S

**DE-546**  
H6-H7  
Scaler  
Sickle

**DE-547**  
H5-U15  
Scaler  
Sickle

**DE-548**  
H5-13  
Scaler  
Sickle

**DE-549**  
U15-30  
Scaler  
Sickle

**DE-550**  
U15-33  
Scaler  
Sickle

10 01cm 012 013 014 015 016 017 018 019 020 021 022 023 024  
CENTIMETERS

# FILLING INSTRUMENTS

- Инструменты для реставрации
- Instruments pour plombage
- Füllungsinstrumente (mit Kontrawinkel)
- Инструменти для реставрації
- Instrumentos para obturaciones
- ملء الصكوك

FILLING INSTRUMENTS (Gold Pointed)  
SOLID HANDLE 6MM, LENGTH 170MM



Solid Handle Size 4.25"

Tip Size: 1/1

DE-551 1.5mm / 1.5mm

DE-552 2.0mm / 2.0mm

DE-553 2.0mm / 2.0mm

DE-554 2.5mm / 2.5mm

DE-555 1.3mm / 0.9mm

DE-556 1.6mm / 1.3mm

DE-557 2.4mm / 1.8mm

DE-558 2.4mm / 2.0mm

DE-559 1.3mm / 1.5mm

DE-560 1.8mm / 1.2mm

Filling instrument, spatula 6 mm solid handle, length 170 mm,

Filling instrument 6 mm length 175 mm,

Filling instrument, ball 6 mm length 170 mm,

Filling instrument, ball / spatula 6 mm length 175 mm,

Filling instrument, plan / plan 6 mm length 165 mm,

## EXPLORERS INSTRUMENTS SOLID HANDLE 6MM, LENGTH 170MM

- Зонды
  - Sondes
  - Zahnsonden
- Зонди
  - Sondas
  - المستكشفين



### PLUGGERS

 .50 <b>DE-562</b> 5/7 21mm	 1.00 <b>DE-563</b> 9/11 21mm	 .50 <b>DE-564</b> 1/2 Root Canal Plugger	 .80 <b>DE-565</b> 3/4 Root Canal Plugger
 .75 <b>DE-561</b> 1/3 21mm	 1.15	 .60 <b>DE-566</b> MA57 27mm	 1.10 <b>DE-567</b> GP3 30mm
 .30 <b>DE-568</b> ISO Size 30 24mm	 .40 <b>DE-569</b> ISO Size 40 24mm	 .50 <b>DE-570</b> ISO Size 50 24mm	 .60 <b>DE-571</b> ISO Size 60 24mm

# PERIODONTAL PROBES

- Зонды пародонтологические
- Sondes paradontales
- sonda paradontali
- зонди пародонтологічні
- Sondas paradontales
- المسابر اللثة

## SPREADERS

## HEAT CARRIERS

Tip Size: 1/1

Solid Handle Size 4.25"

Model	ISO / Other	Size	Length
DE-572	ISO	Size 30	24mm
DE-573	ISO	Size 40	24mm
DE-574	ISO	Size 50	28mm
DE-575	ISO	Size 60	28mm
DE-576	GP1	20mm	25mm
DE-577	1S Wakai	22mm	30mm
DE-578	2S Wakai	22mm	40mm
DE-579	D11 Standard	23mm	40mm
DE-580	D11S Thin	23mm	35mm
DE-581	D11T Thinner	22mm	23mm
DE-582	D11TS Thinnest	21mm	20mm
DE-583	3	28mm	35mm
DE-584	GP2	25mm	25mm
DE-585	0‡	25mm	35mm
DE-586	00‡	25mm	55mm

## HEAT CARRIERS

- Зонды пародонтологические
  - Sondes paradontales
  - sonda parodontali
- зонди пародонтологічні
  - Sondas paradontales
  - المسبار اللثة

**ENDODONTICS INSTRUMENTS**

**ANTERIOR**



**DE-587**  
8A  
29mm

**DE-592**  
10 1/2A  
29mm

**DE-593**  
11A  
29mm

**DE-594**  
11 1/2A  
29mm

**DE-595**  
12A  
29mm

**LUKS**



**DE-596**  
L1  
18mm

**DE-597**  
L2  
18mm

**DE-598**  
L3  
18mm

**DE-599**  
L4  
18mm

0 0.1cm 0.2 0.3 0.4 0.5 0.6 0.7 0.8 0.9 1.0 1.1 1.2 1.3 1.4 1.5 1.6 1.7 1.8 1.9 2.0 2.1 2.2 2.3 2.4  
CENTIMETERS

# PERIODONTAL PROBES

- Зонды пародонтологические
- Sondes paradontales
- sonda paradontali
- зонди пародонтологічні
- Sondas paradontales
- المصابير اللثة

## ENDODONTICS INSTRUMENTS SOLID HANDLE 6MM, LENGTH 170MM

### POSTERIOR

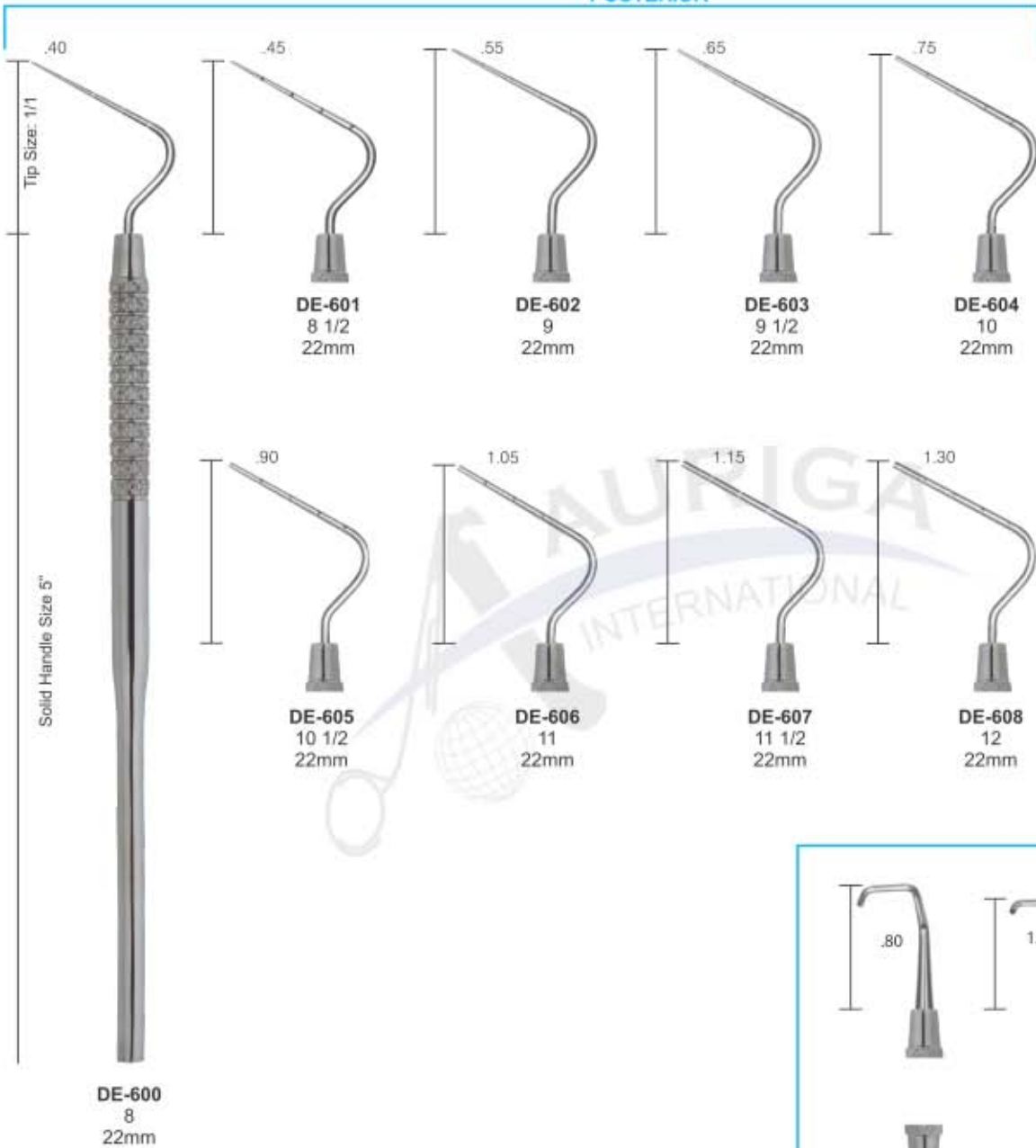

### RETRO FILLING PLUGGERS

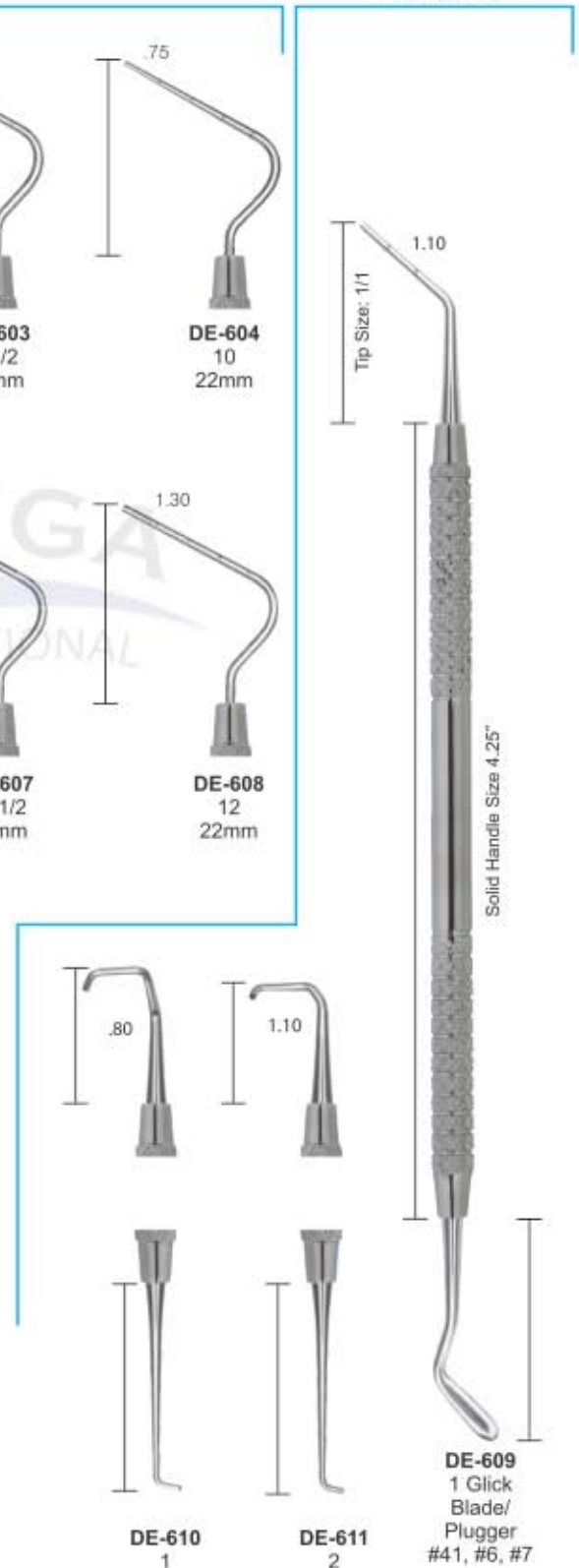

- Инструменты для реставрации
- Instruments pour plombage
- Füllungsinstrumente (mit Kontrawinkel)

- Инструменти для реставрації
- Instrumentos para obturaciones
- ملء الصكوك

## COMPOSITE/PLASTIC FILLING INSTRUMENTS SOLID HANDLE 6MM, LENGTH 170MM

## POSTERIOR



## UNIVERSAL FILLING INSTRUMENTS

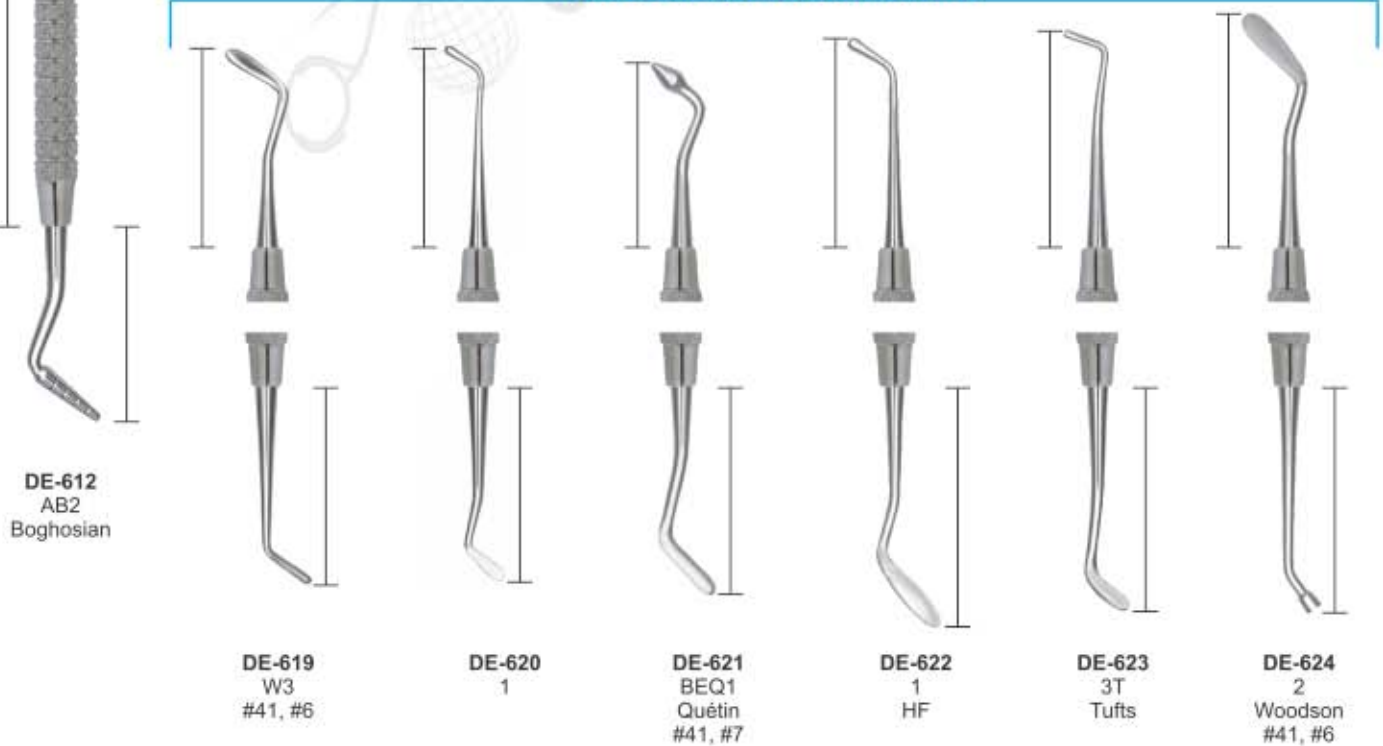

# FILLING INSTRUMENTS

- Инструменты для реставрации
- Instruments pour plombage
- Füllungsinstrumente (mit Kontrawinkel)
- Инструменти для реставрації
- Instrumentos para obturaciones
- ملء الصكوك

COMPOSITE/PLASTIC FILLING INSTRUMENTS SOLID HANDLE 6MM, LENGTH 170MM

BLACK

PLUGGERS/CONDENSERS

Hollenback

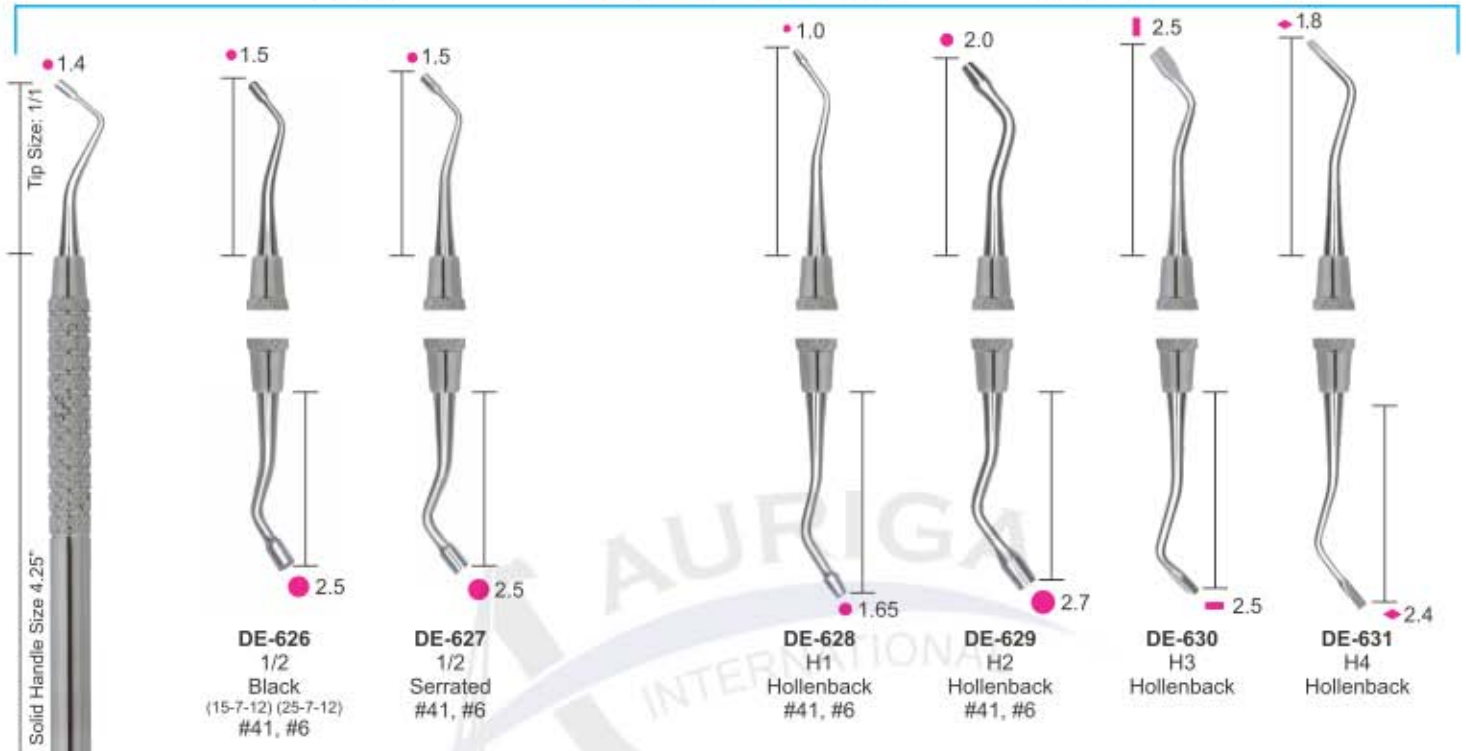

MARQUETTE CONDENSER

MORTONSON

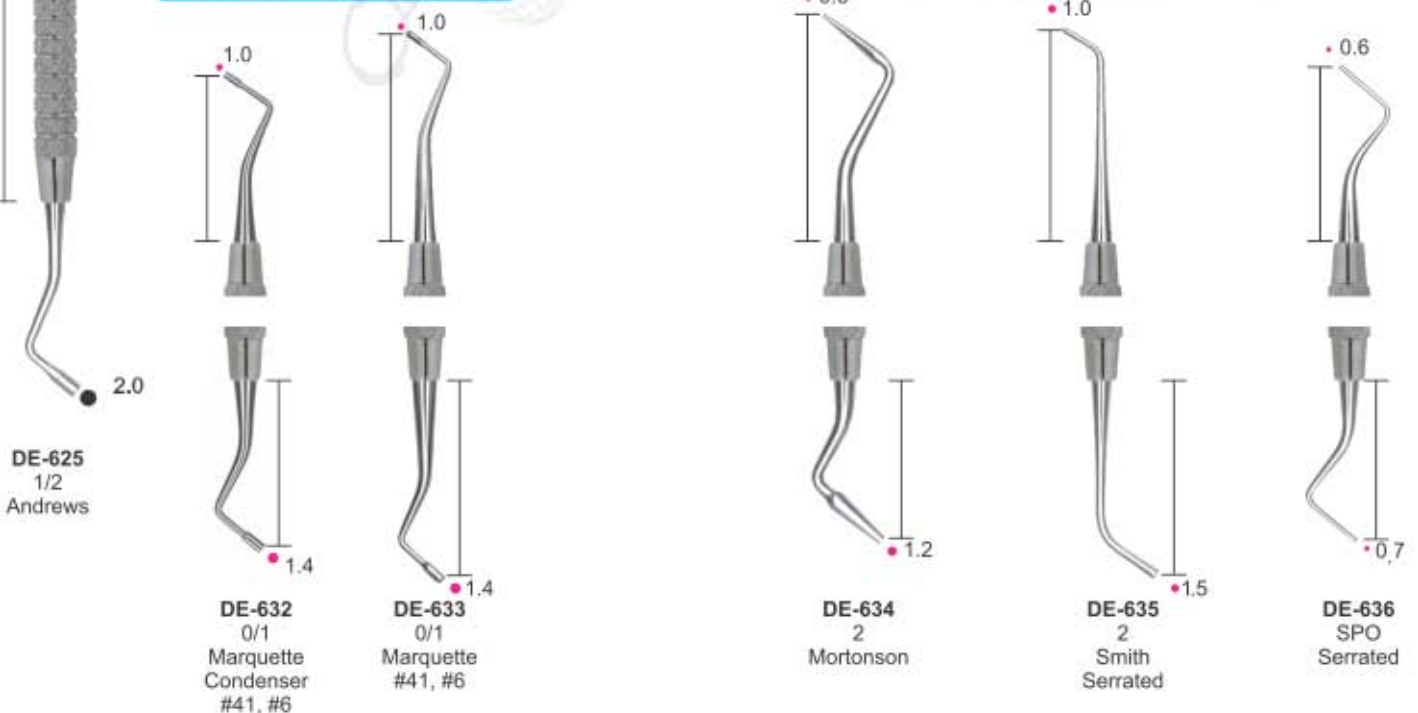

- Инструменты для реставрации
- Instruments pour plombage
- Füllungsinstrumente (mit Kontrawinkel)

- Инструменти для реставрації
- Instrumentos para obturaciones
- ملء الصكوك

## PLUGGERS/CONDENSERS

## RESTORATIVE INSTRUMENTS SOLID HANDLE 6MM, LENGTH 170MM

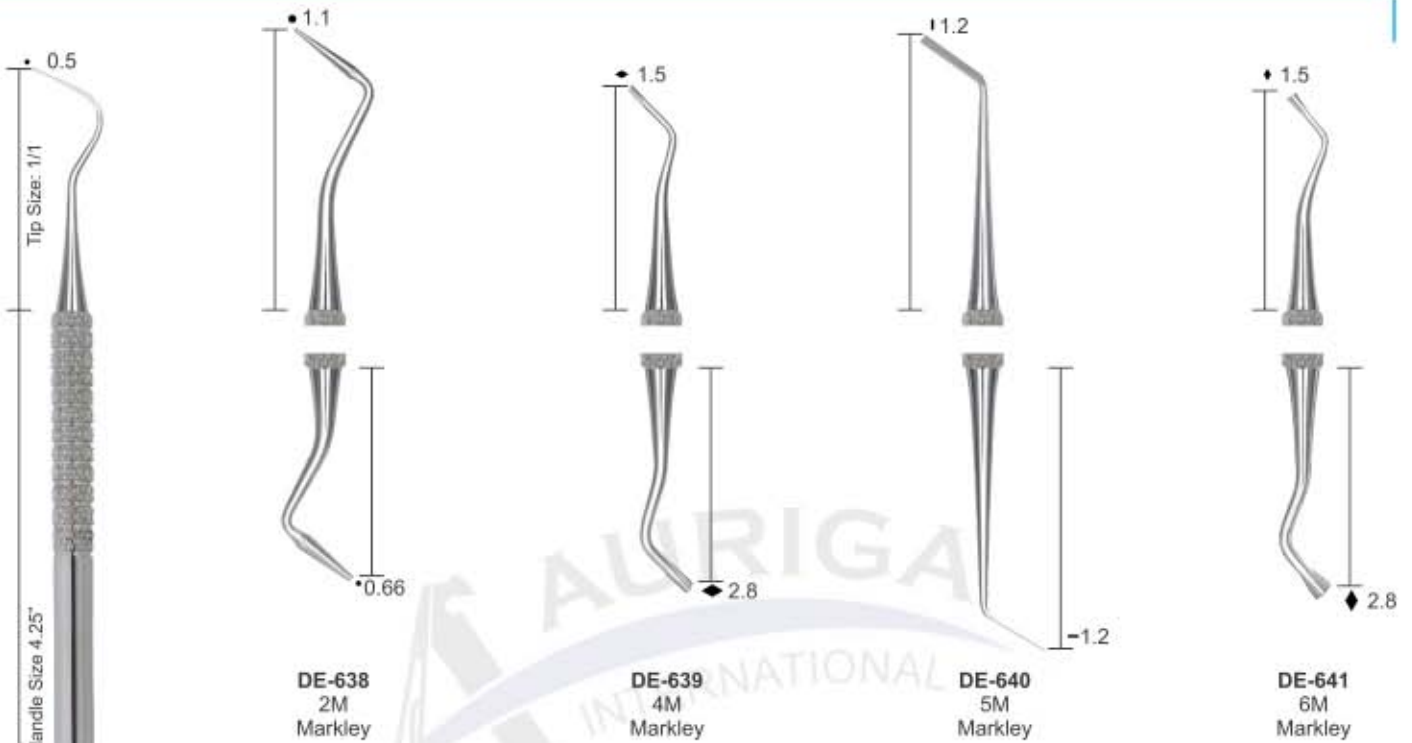

## PLUGGERS/CONDENSERS

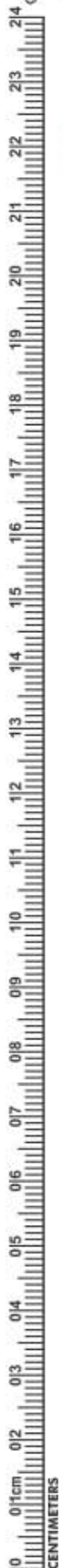
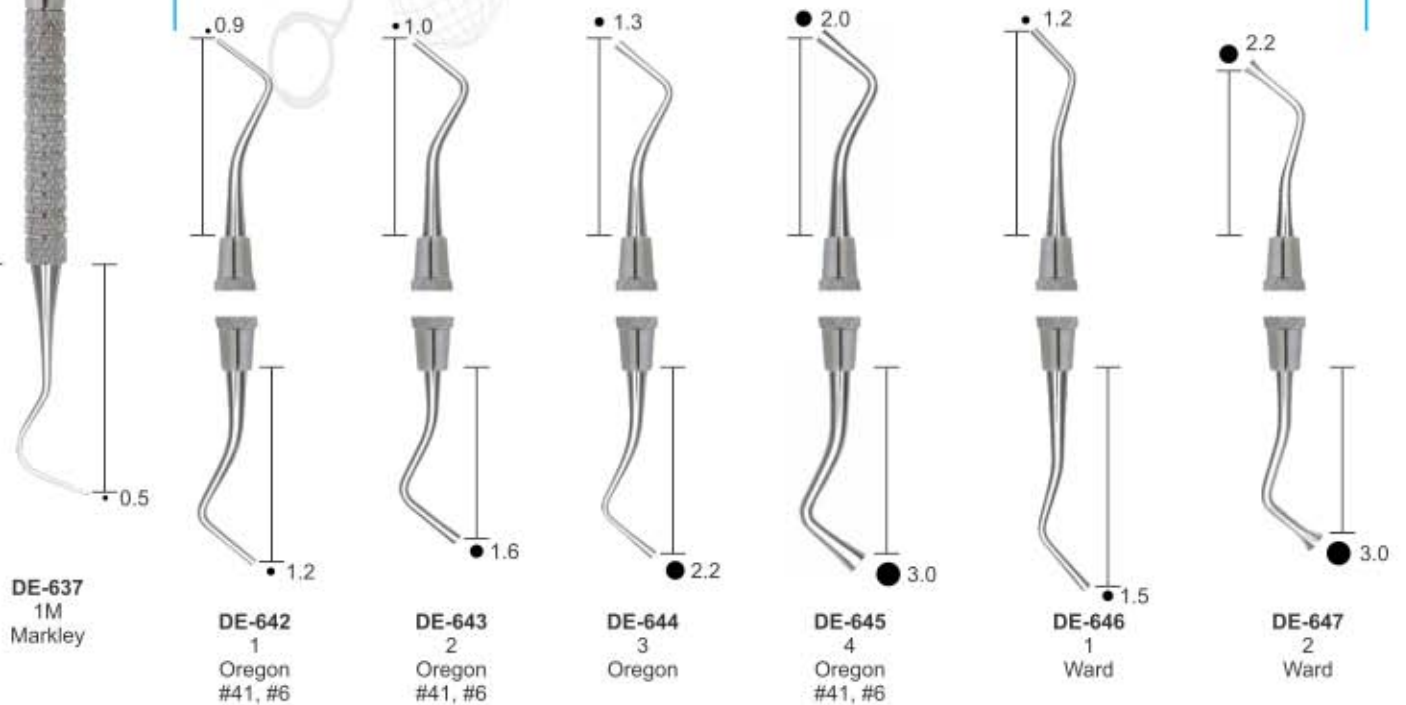

# FILLING INSTRUMENTS

- Инструменты для реставрации
- Instruments pour plombage
- Füllungsinstrumente (mit Kontrawinkel)
- Инструменти для реставрації
- Instrumentos para obturaciones
- ملء الصكوك

## RESTORATIVE INSTRUMENTS SOLID HANDLE 6MM, LENGTH 170MM

**Tanner Filling Instruments**

- DE-649 2T Tanner (Tip Size: 1.7, Solid Handle Size: 4.25")
- DE-650 3T Tanner (Tip Size: 1.0, Solid Handle Size: 4.25")
- DE-651 9/10 Back Action (Tip Size: 1.2, Solid Handle Size: 4.25")
- DE-652 11/12 Back Action (Tip Size: 1.5, Solid Handle Size: 4.25")
- DE-653 153 English Pattern Serrated (Tip Size: 1.5, Solid Handle Size: 4.25")
- DE-654 153 English Pattern Serrated (Tip Size: 1.4, Solid Handle Size: 4.25")

**RESTORATIVE INSTRUMENTS SOLID HANDLE 6MM, LENGTH 170MM Back Action Filling Instruments**

- DE-651 9/10 Back Action (Tip Size: 1.2, Solid Handle Size: 4.25")
- DE-652 11/12 Back Action (Tip Size: 1.5, Solid Handle Size: 4.25")
- DE-653 153 English Pattern Serrated (Tip Size: 1.5, Solid Handle Size: 4.25")
- DE-654 153 English Pattern Serrated (Tip Size: 1.4, Solid Handle Size: 4.25")

**BURNISHERS**

- BALL**
  - DE-648 1T Tanner (Tip Size: 2.3, Solid Handle Size: 4.25")
  - DE-655 18 #41, #6 (Tip Size: 2.4, Solid Handle Size: 4.25")
  - DE-656 26/27S #41, #6 (Tip Size: 2.1, Solid Handle Size: 4.25")
  - DE-657 27/29 #41, #6, #7, #8 (Tip Size: 1.6, Solid Handle Size: 4.25")
- BEAVERTAIL**
  - DE-658 2 (Tip Size: 2.6, Solid Handle Size: 4.25")
- ACORN**
  - DE-659 2 Double-End (Tip Size: 2.6, Solid Handle Size: 4.25")
  - DE-660 21 #41, #6 (Tip Size: 2.7, Solid Handle Size: 4.25")
  - DE-661 21B #41, #6, #8 (Tip Size: 3.0, Solid Handle Size: 4.25")
- LADMORE**
  - DE-662 2 Ladmore (Tip Size: 1.9, Solid Handle Size: 4.25")

- Инструменты для реставрации
- Instruments pour plombage
- Füllungsinstrumente (mit Kontrawinkel)

- Инструменти для реставрації
- Instrumentos para obturaciones
- ملء الصكوك

## RESTORATIVE INSTRUMENTS SOLID HANDLE 6MM, LENGTH 170MM

### BURNISHERS

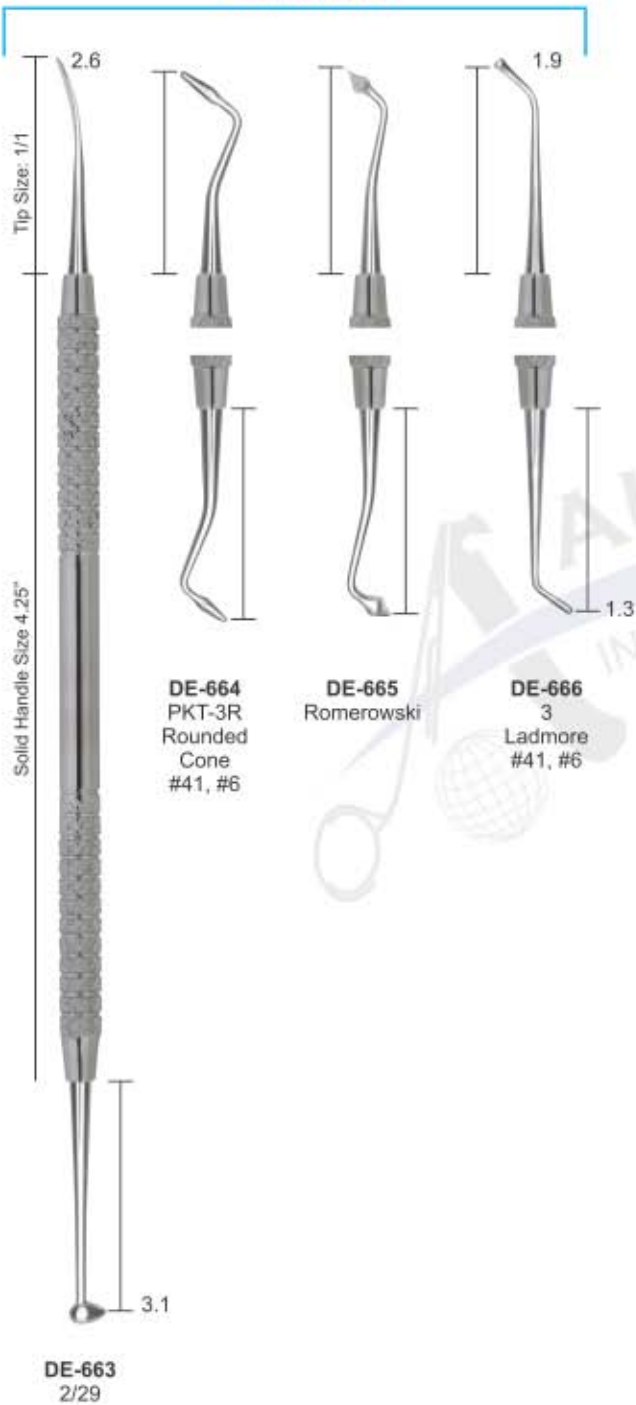

### PERIODONTAL FILES

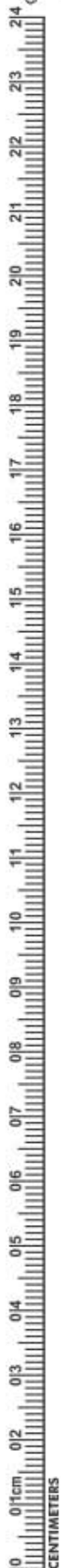

# FILLING INSTRUMENTS

- Инструменты для реставрации
- Instruments pour plombage
- Füllungsinstrumente (mit Kontrawinkel)
- Инструменти для реставрації
- Instrumentos para obturaciones
- ملء الصكوك

COMPOSITE/PLASTIC FILLING INSTRUMENTS  
SOLID HANDLE 6MM, LENGTH 170MM

## BURNISHER FILLING INSTRUMENTS

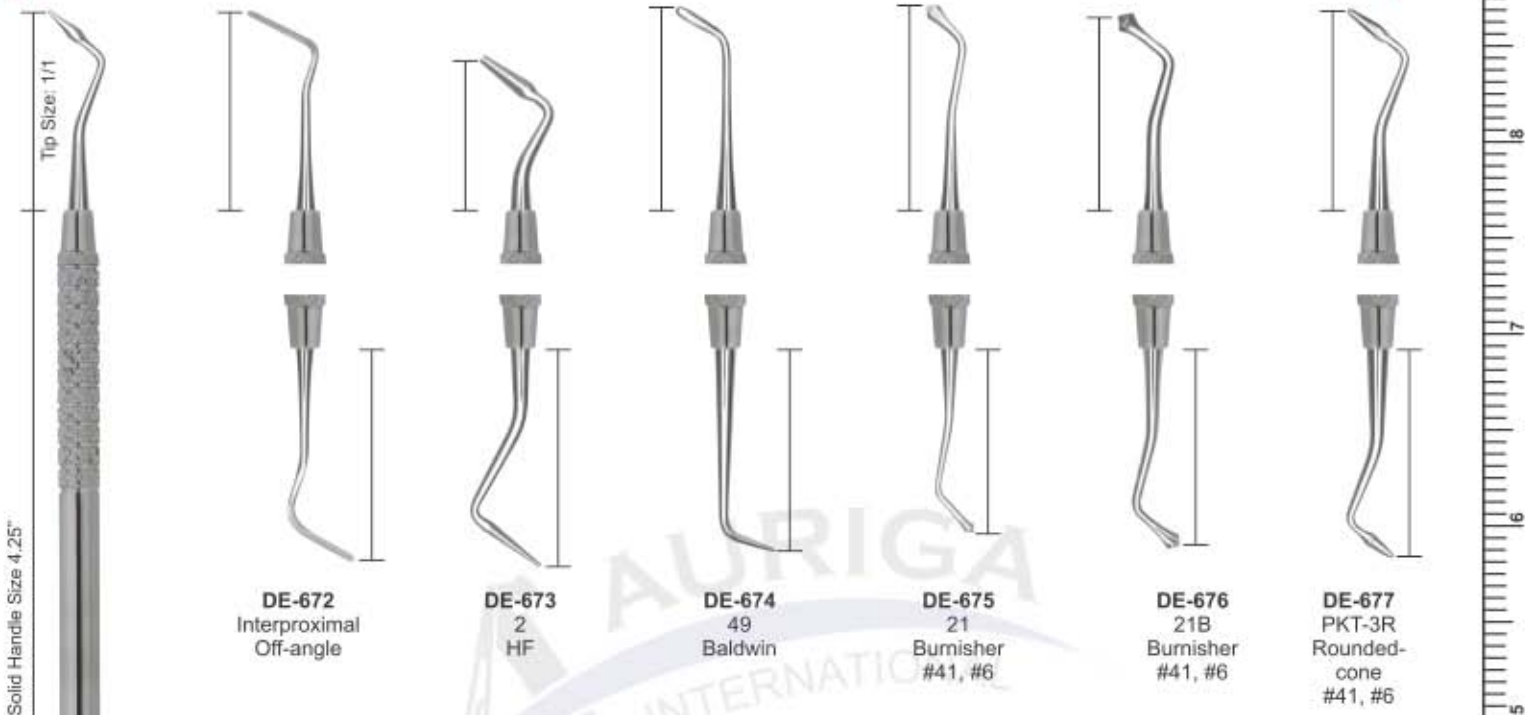

**DE-672**  
Interproximal  
Off-angle

**DE-673**  
2  
HF

**DE-674**  
49  
Baldwin

**DE-675**  
21  
Burnisher  
#41, #6

**DE-676**  
21B  
Burnisher  
#41, #6

**DE-677**  
PKT-3R  
Rounded-  
cone  
#41, #6

## UNIVERSAL FILLING INSTRUMENTS



**DE-671**  
AB2  
Boghosian

**DE-678**  
W3  
#41, #6

**DE-679**  
1

**DE-680**  
BEQ1  
Quétin  
#41, #7

**DE-681**  
1  
HF

**DE-682**  
3T  
Tufts

**DE-683**  
2  
Woodson  
#41, #6

- Инструменты для реставрации
- Instruments pour plombage
- Füllungsinstrumente (mit Kontrawinkel)

- Инструменти для реставрації
- Instrumentos para obturaciones
- ملء الصكوك

## FILLING INSTRUMENTS SOLID HANDLE 6MM, LENGTH 170MM

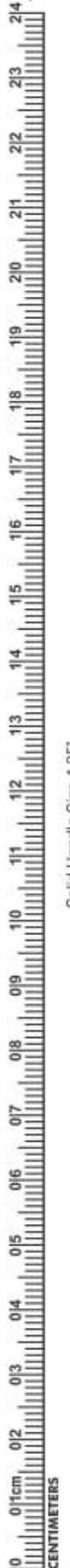

# AMALGAM CARVERS

- Инструменты для реставрации
- Instruments pour amalgame
- Amalgampistolen
- Инструменти для реставрації
- instrumentos para amalgama
- تطعيم الملعق

## AMALGAM INSTRUMENTS SOLID HANDLE 6MM, LENGTH 170MM



- Инструменты для реставрации
- Instruments pour amalgame
- Amalgampistolen

- Инструменти для реставрації
- instrumentos para amalgama
- تقطیع المنقب

## AMALGAM INSTRUMENTS SOLID HANDLE 6MM, LENGTH 170MM

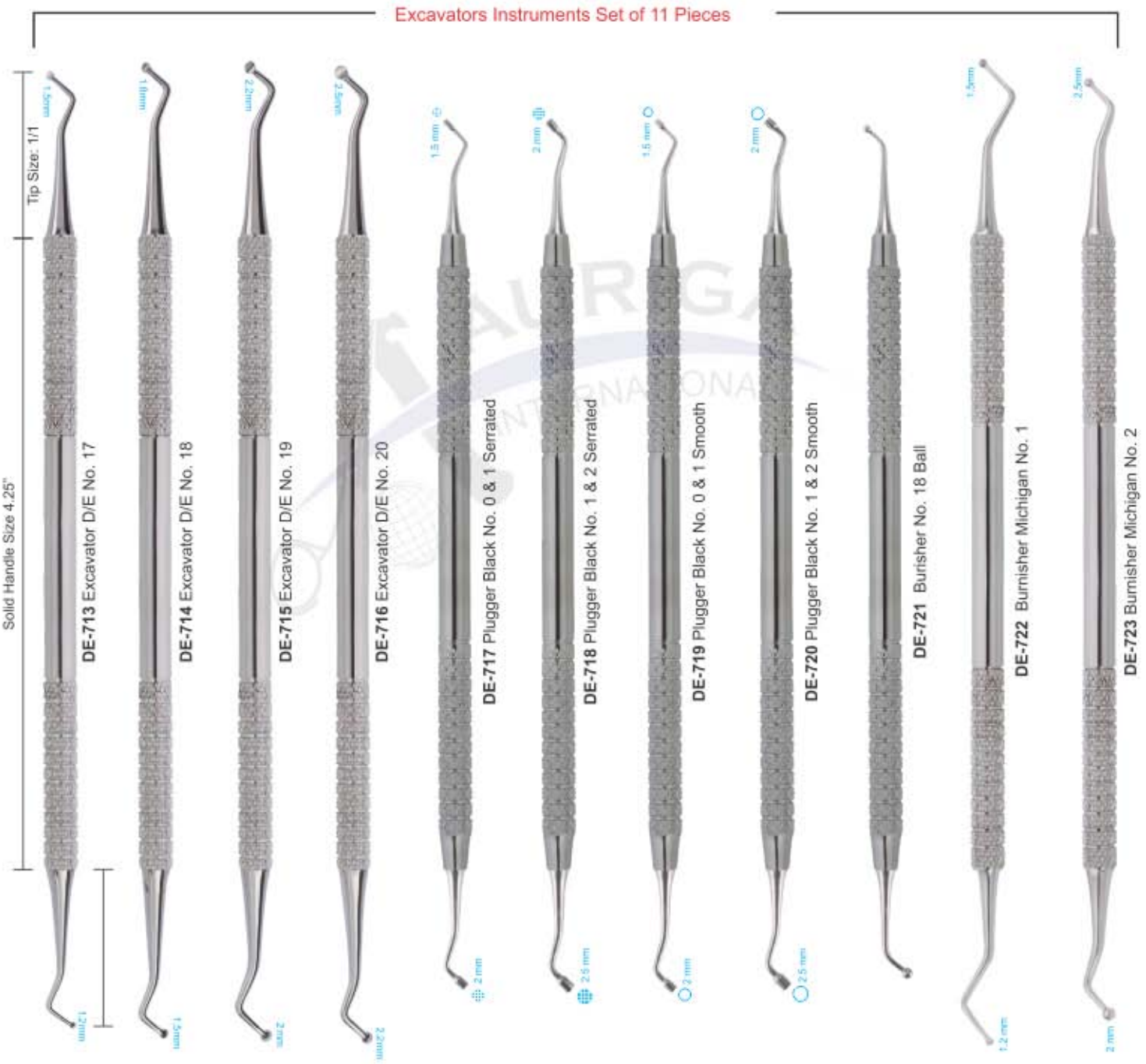
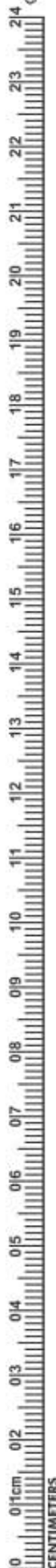

# PERIODONTAL INSTRUMENTS

- Инструменты пародонтологические
- Instruments pour la parodontologie
- Instrumente für die Parodontologie
- Інструменти пародонтологічні
- instrumentos para periodoncia
- المسكوك اللثة

## SICKLE SCALERS INSTRUMENTS SOLID HANDLE 6MM, LENGTH 170MM

### SICKLE SCALERS



- Инструменты пародонтологические
- Instruments pour la parodontologie
- Instrumente für die Parodontologie

- Инструменти пародонтологічні
- instrumentos para periodoncía
- الصوك اللثة

## PERIODONTAL INSTRUMENTS SOLID HANDLE 6MM, LENGTH 170MM

### JACQUETTE SCALERS

### CRANE-KAPLAN



**DE-731**  
30/33  
Hygienist  
Jacquette  
#2, #4, #6,  
#7, #8, #9

**DE-732**  
31/32  
Jacquette  
#2, #4, #6,  
#7, #8, #9

**DE-733**  
34/35  
Jacquette  
#2, #4, #6,  
#7, #8, #9

**DE-734**  
H3/H4  
Jacquette  
#2, #4, #6,

**DE-735**  
14/15  
Posterior  
Jacquette  
#2, #4, #6,

**DE-736**  
CK-6  
#2, #4, #6,

0 01cm 02 03 04 05 06 07 08 09 10 11 12 13 14 15 16 17 18 19 20 21 22 23 24  
CENTIMETERS

# PERIODONTAL INSTRUMENTS

- Инструменты пародонтологические
- Instruments pour la parodontologie
- Instrumente für die Parodontologie
- Инструменти пародонтологічні
- instrumentos para periodoncia
- الصكوك اللثة

## PERIODONTAL INSTRUMENTS SOLID HANDLE 6MM, LENGTH 170MM SCALER/CURETTE SETS



Tip Size: 1/1

Solid Handle Size 4.25"

**DE-737**  
11/12  
Scaler  
#2, #6,  
#7, #8

**DE-738**  
11A/12A  
Scaler  
#2, #4, #6,

**DE-739**  
11/12S  
Modief  
McCall  
#4, #6

**DE-740**  
13S/14S  
Pointed  
Curette  
#2, #4, #6  
#7, #8, #9

**DE-741**  
MTC 13/14  
Pointed  
Curette  
#4, #6

**DE-742**  
17S/18S  
Curette  
#2, #4, #6  
#7, #8, #9

**DE-743**  
19/20  
Curette  
#2

INCHES

- Кюрети
- Curetas
- Küretten
- Кюрети
- Curette
- کرتس

## SCALER/CURETTE SETS

## GOLDMAN-FOX SET

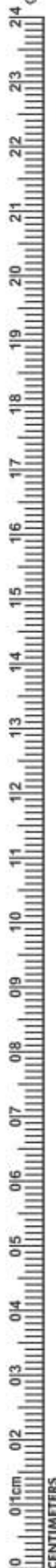

<b>DE-744</b> 103/106 #4, #6	<b>DE-744A</b> 104/105 Hoe/Chisel #4, #6	<b>DE-745</b> 107/108 #2, #4, #6 #7, #8	<b>DE-746</b> 107/108S Modied #2, #4	<b>DE-747</b> 1/2 (shown) #2, #4, #6 #7, #8, #9	<b>DE-749</b> 3/4† (shown) #2, #4, #6 #7, #8, #9	<b>DE-751</b> 5/6† (shown) #2, #4, #6 #7, #8, #9	<b>DE-754</b> 7/8† (shown) #2, #4, #6 #7, #8, #9
<b>DE-748</b> 1/2 Rigid #2, #4, #6 #7, #8, #9	<b>DE-750</b> 3/4 Rigid #2, #4, #6 #7, #8, #9	<b>DE-752</b> 5/6 Rigid #2, #4, #6 #7, #8, #9	<b>DE-753</b> 5/6 Extra Rigid #4, #6 #7, #8	<b>DE-755</b> 7/8 Rigid #2, #4, #6 #7, #8, #9	<b>DE-756</b> 7/8 Extra Rigid #2, #4, #6 #7, #8, #9		

**SCALER/CURETTE SETS INSTRUMENTS  
SOLID HANDLE 6MM, LENGTH 170MM**

# CURETTES

- Кюрети
- Curetas
- Küretten
- Кюрети
- Curette
- كرتس

**GRACEY CURETTE INSTRUMENTS SOLID HANDLE 6MM, LENGTH 170MM**  
**GRACEY CURETTES**



**DE-757**  
 9/10†  
 (shown)  
 #2, #4, #6  
 #7, #8, #9

**DE-759**  
 11/12†  
 (shown)  
 #2, #4, #6  
 #7, #8, #9

**DE-792**  
 13/14†  
 (shown)  
 #2, #4, #6  
 #7, #8, #9

**DE-765**  
 15/16†  
 (shown)  
 #2, #4, #6  
 #7, #8, #9

**DE-767**  
 17/18  
 #2, #4, #6  
 #7, #8, #9

**DE-758**  
 9/10  
 Rigid  
 #2, #4, #6  
 #7, #8

<b>DE-760</b>	<b>DE-761</b>
11/12	11/12
Rigid	Extra Rigid
#2, #4, #6	#4, #6 #7,
#7, #8, #9	#8

<b>DE-793</b>	<b>DE-764</b>
13/14	13/14
Rigid	Extra Rigid
#2, #4, #6	#4, #6 #7,
#7, #8, #9	#8

**DE-766**  
 15/16  
 Rigid  
 #2, #4, #6  
 #7, #8, #9

**DE-768**  
 17/18  
 Rigid  
 #2, #4, #6  
 #7, #8, #9



- Кюрети
  - Curetas
  - Küretten
- Кюрети
  - Curette
  - كرتس

**CURETTE INSTRUMENTS  
HOLLOW HANDLE 8.5MM, LENGTH 170MM**

**CURETTE INSTRUMENTS  
SOLID HANDLE 6MM, LENGTH 170MM**

**CURETTE INSTRUMENTS  
SOLID HANDLE 6MM, LENGTH 170MM**



**DE-769**  
Hemingway  
2mm, 2mm

**DE-770**  
Hemingway  
3mm, 3mm

**DE-771**  
Hemingway  
4mm, 4mm



**DE-772**  
Hemingway  
2mm, 2mm

**DE-773**  
Hemingway  
3mm, 3mm

**DE-774**  
Hemingway  
4mm, 4mm



**DE-775**  
Hemingway  
2mm, 2mm

**DE-776**  
Hemingway  
3mm, 3mm

**DE-777**  
Hemingway  
4mm, 4mm



# EXCAVATORS

- Экскаваторы
- Excavateurs
- Excavatoren
- Excavatori
- Excavadores
- حفارات

## EXCAVATORS INSTRUMENTS SOLID HANDLE 6MM, LENGTH 170MM SPOONS



- Экскаваторы
- Excavateurs
- Excavatoren
- Экскаватори
- Excavadores
- حفرات

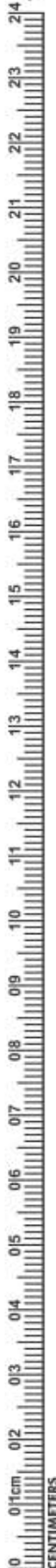

OVAL SPOONS/DARBY-PERRY

EXCAVATORS INSTRUMENTS  
SOLID HANDLE 6MM, LENGTH 170MM

EXCAVATORS

Instrument Model	Tip Size	Handle Size
DE-787 17W	1.2	4.25
DE-788 18W	1.5	4.25
DE-789 19W	1.8	4.25
DE-790 220/221 Darby-Perry #41, #6	1.5	4.25
DE-791 2 Glick	1.5	4.25
DE-792 31L #41, #6	1.0	4.25
DE-793 31W Oval Spoon	1.3	4.25
DE-794 32L #41, #6	1.5	4.25
DE-795 33L #41, #6	2.0	4.25

# EXCAVATORS

- Экскаваторы
- Excavateurs
- Excavatoren
- Excavatori
- Excavadores
- حفارات

## EXCAVATORS INSTRUMENTS SOLID HANDLE 6MM, LENGTH 170MM

### BLADES



- Экскаваторы
- Excavateurs
- Excavatoren
- Экскаватори
- Excavadores
- حفارات

EXCAVATORS INSTRUMENTS SOLID HANDLE 6MM, LENGTH 170MM

ENGLISH PATTERNS



<b>DE-802</b> Goldstein Interproximal Excavator	<b>DE-803</b> 243	<b>DE-804</b> 244	<b>DE-805</b> 245	<b>DE-806</b> 246	<b>DE-807</b> 125/126 #41, #6	<b>DE-808</b> 127/128 #41, #6	<b>DE-809</b> 129/130 #41, #6	<b>DE-810</b> 131/132 #41, #6	<b>DE-811</b> 153/154
--	----------------------	----------------------	----------------------	----------------------	-------------------------------------	-------------------------------------	-------------------------------------	-------------------------------------	--------------------------

# FILLING INSTRUMENTS

- Инструменты для реставрации
- Instruments pour plombage
- Füllungsinstrumente (mit Kontrawinkel)
- Инструменти для реставрації
- Instrumentos para obturaciones
- ملء الصكوك

## HATCHETS

## RESTORATIVE INSTRUMENTS SOLID HANDLE 6MM, LENGTH 170MM

Tip Size: 1/1

Solid Handle Size 4.25"

**DE-813**  
13/14  
(20-9-14)

**DE-814**  
15/16  
(15-8-14)

**DE-815**  
17/18  
(10-6-14)  
#41, #6

**DE-816**  
51/52  
(15-8-12)

**DE-817**  
53/54  
(10-6-12)  
#41, #6

**DE-812**  
8/9H  
(10-7-14)  
#41, #6

**DE-818**  
8A  
#41, #6

**DE-819**  
11  
#41, #6

**DE-820**  
179

**DE-821**  
G

**DE-822**  
1/2  
Trico

**DE-823**  
DPT6  
Darby Perry  
Trimmer

**DE-824**  
W1

**DE-825**  
1  
Woodson  
#41, #6

**ANTERIOR**

INCHES

- Инструменты для реставрации
- Instruments pour plombage
- Füllungsinstrumente (mit Kontrawinkel)
- Инструменти для реставрації
- Instrumentos para obturaciones
- ملء الصكوك

## CARVERS

## RESTORATIVE INSTRUMENTS SOLID HANDLE 6MM, LENGTH 170MM

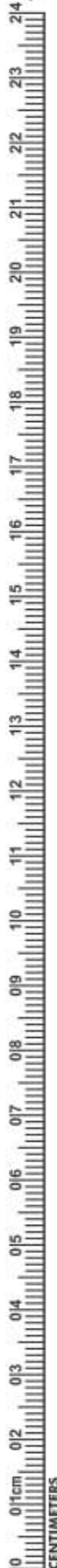

**DE-827**  
Inter-proximal  
Off-Angle

**DE-828**  
1/2-3  
Hollenback  
#41, #6,  
#7, #8

**DE-829**  
3S  
Hollenback  
#41, #6, #7

**DE-830**  
3  
Hollenback

**DE-831**  
8  
Wiland  
Minn.IPC1  
#41, #6, #7

### TANNER

### WALL

### WARD

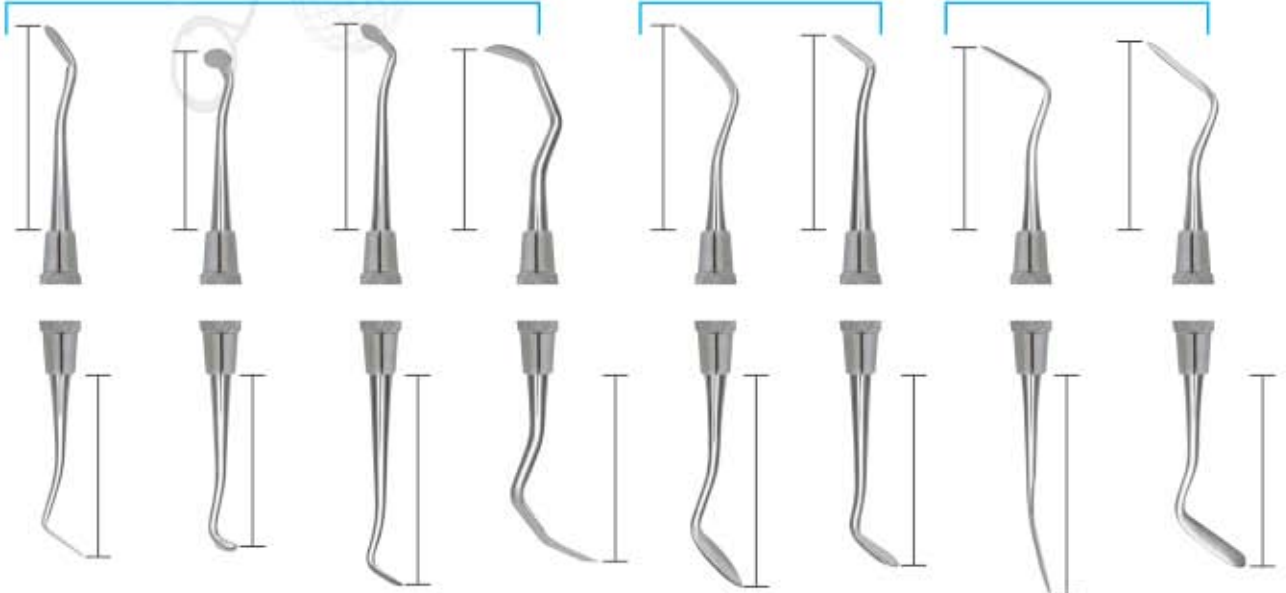

**DE-826**  
Inter-proximal  
#41, #6, #7

**DE-832**  
3  
Tanner

**DE-833**  
4  
Tanner

**DE-834**  
5  
Tanner

**DE-835**  
6  
Tanner

**DE-836**  
1  
Wall

**DE-837**  
3  
Wall

**DE-838**  
1  
Ward

**DE-839**  
2  
Ward

# AMALGAM CARVERS

- Инструменты для реставрации
- Instruments pour amalgame
- Amalgampistolen
- Инструменти для реставрації
- instrumentos para amalgama
- تقطیع الملقم

## RESTORATIVE INSTRUMENTS

ANDREW SOLID HANDLE 6MM, LENGTH 170MM CLAPPISON/FRAHAM

HOLLENBACK



DE-841  
2  
Andrew

DE-842  
3  
Andrew

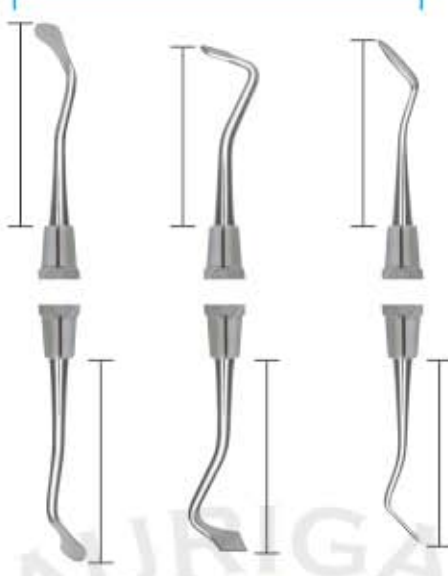

DE-843  
4  
Clappison

DE-844  
2/3  
Frahm  
#41, #6

DE-845  
104



DE-846  
1 Hollenback  
2 Modified  
Cleoid Small

DE-847  
1 Hollenback  
2 Modified  
Cleoid Large



DE-848  
1  
Hollenback

DE-849  
2  
Hollenback

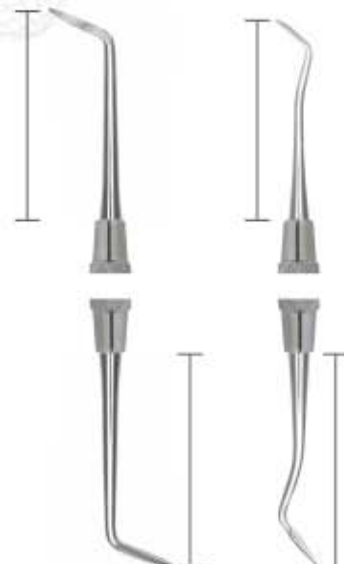

DE-850  
L7  
Levy

DE-851  
SHO-A  
Shoshan



DE-852  
18  
Sprengel

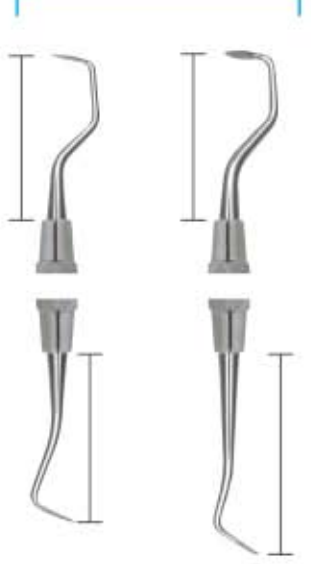

DE-853  
1  
Tharp

DE-854  
2  
Tharp

DE-840  
1  
Andrew



- Инструменты для реставрации
- Instruments pour amalgame
- Amalgampistolen
- Инструменти для реставрації
- instrumentos para amalgama
- تقطیع المنقب

## RESTORATIVE INSTRUMENTS SOLID HANDLE 6MM, LENGTH 170MM

### CARVERS

### AMALGAM FILES

### HOES

Forming Line Angles on Anterior Preparations.



**DE-856**  
Discoid-Cleoid  
Carver

**DE-855**  
Anatomical  
Carver



**DE-857**  
31/32  
Rhein

**DE-858**  
1/4  
Wedelstaedt

**DE-859**  
2/5  
Wedelstaedt

### DISCOID-CLEOIDS

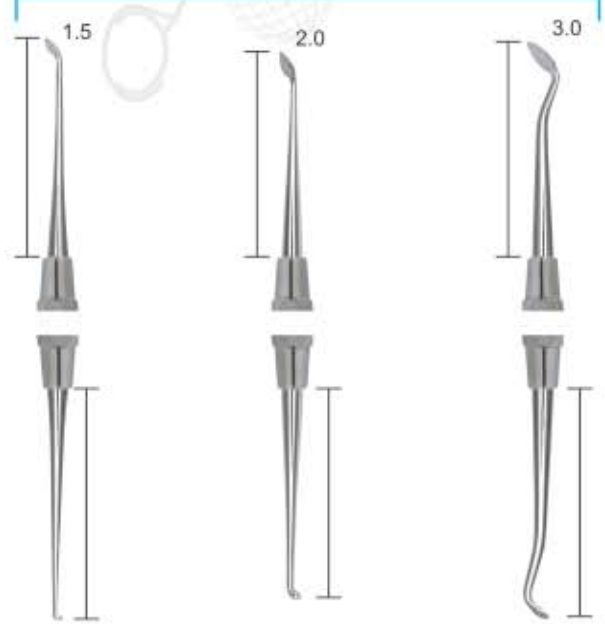

**DE-860**  
1/2

**DE-861**  
4/5  
#41, #6, #7

**DE-862**  
3/6  
#41, #6, #7



**DE-864**  
21  
(10-4-8)

**DE-865**  
22  
(10-4-14)

**DE-866**  
23  
(6.5-2.5-9)



**DE-863**  
20  
(14-6-8)

### DISCOID-CLEOIDS

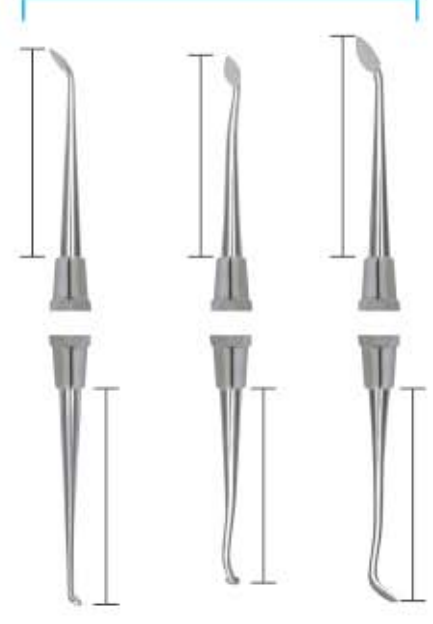

**DE-867**  
89/92  
#41, #6, #7

**DE-868**  
90B

**DE-869**  
W-A-C-D

# FILLING INSTRUMENTS

- Инструменты для реставрации
- Instruments pour plombage
- Füllungsinstrumente (mit Kontrawinkel)
- ملء الصكوك
- Инструменти для реставрації
- Instrumentos para obturaciones

**RESTORATIVE INSTRUMENTS**  
SOLID HANDLE 6MM, LENGTH 170MM

**MARGIN TRIMMERS**



**DE-870**  
26  
(13-95-8-14)  
Distal



**DE-871**  
27  
(13-80-8-14)  
Mesial



**DE-872**  
28  
(10-95-7-14)  
Distal  
#41, #6



**DE-873**  
29  
(10-80-7-14)  
Mesial  
#41, #6



**DE-874**  
77/78  
(15-95-8-12)  
Distal



**DE-875**  
79/80  
(15-80-8-12)  
Mesial

**ANGLE FORMERS**



**DE-876**  
30/31  
(12-80-5-8)



**DE-877**  
32/33  
(9-80-4-8)



**DE-878**  
34/35  
(7-80-2.5-9)



- Инструменты для реставрации
- Instruments a modeler
- Modellierinstrumente
- Инструменти для реставрації
- Instrumentos para modelar
- أدوات تقطیع

**P.K. THOMS WAXING INSTRUMENTS SOLID HANDLE 6MM, LENGTH 170MM**

**P.K. THOMAS WAXING INSTRUMENTS**



**DE1-884**  
P.k. Thomas Waxing  
Instruments  
Kit



# COMPOSITE FILLING INSTRUMENTS

- Инструменты для реставрации
- Instruments pour plombage
- Füllungsinstrumente (mit Kontrawinkel)
- Инструменти для реставрації
- Instrumentos para obturaciones
- ملء الصكوك

## Composite Gold Tip Instruments

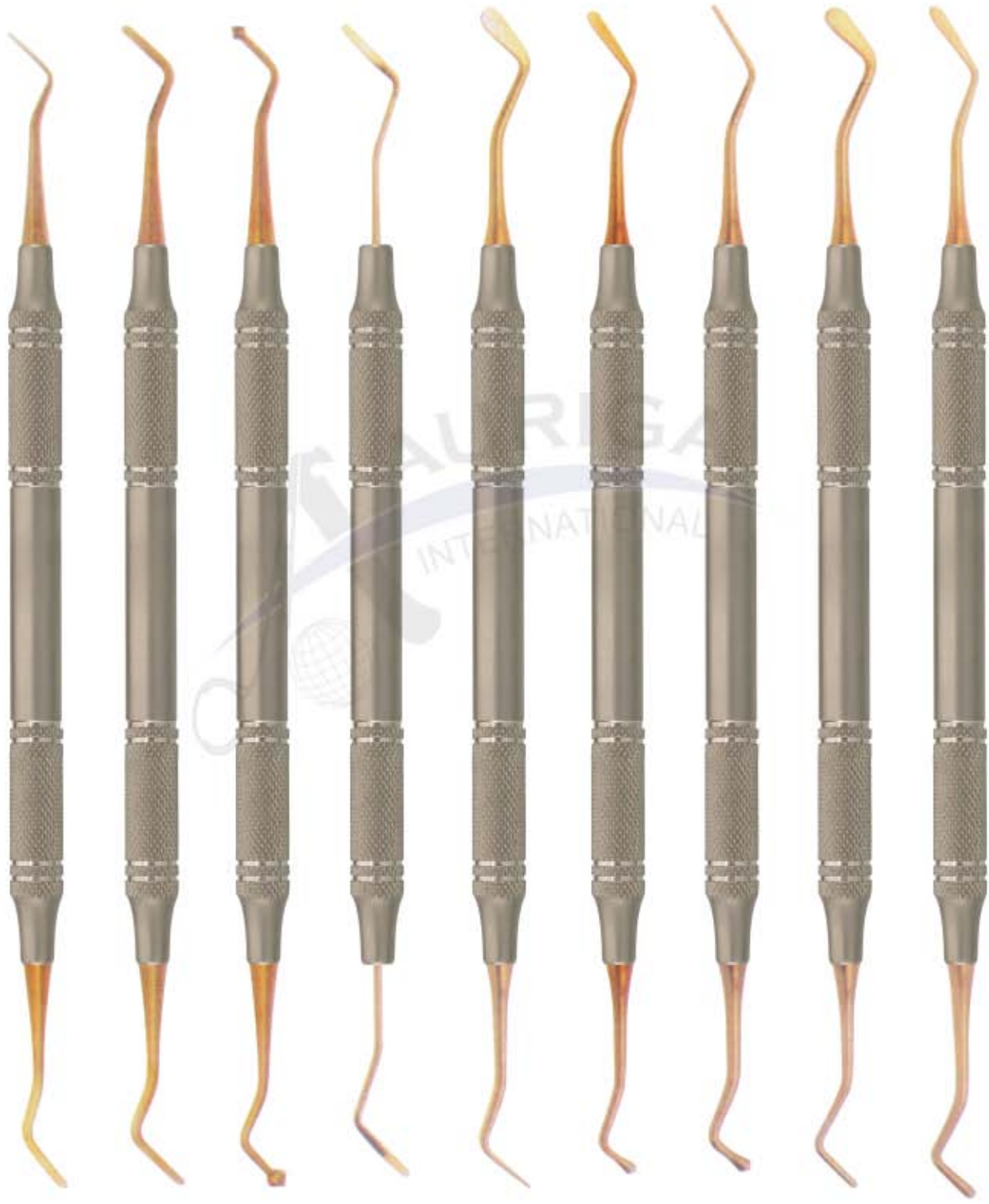

DE1-892

DE2-892

DE3-892

DE4-892

DE5-892

DE6-892

DE7-892

DE8-892

DE9-892

# COMPOSITE FILLING INSTRUMENTS

- Инструменты для реставрации
- Instruments pour plombage
- Füllungsinstrumente (mit Kontrawinkel)

- Инструменти для реставрації
- Instrumentos para obturaciones
- ملء الصكوك

## Composite Gold Tip Instruments



**DE10-892**  
Markley 2



**DE11-892**  
Westcott N.21



**DE12-892**  
NYU/B2



**DE13-892**  
Filling instruments

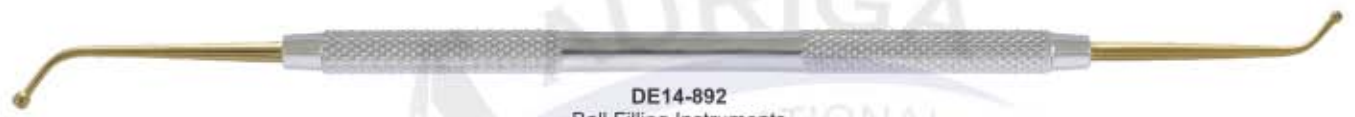

**DE14-892**  
Ball Filling Instruments



**DE15-892**  
Filling Instruments



**DE16-892**  
Filling Instruments



**DE17-892**  
Filling Instruments



**DE18-892**  
Plastic Filling Instruments



**DE19-892**  
Heidemann



**DE20-892**  
Plastic Filling Instruments

# FILLING INSTRUMENTS

- Инструменты для реставрации
  - Instruments pour plombage
  - Füllungsinstrumente (mit Kontrawinkel)
- Инструменти для реставрації
  - Instrumentos para obturaciones
  - ملء الصكوك

## COMPOSITE INSTRUMENTS TITANIUM BLUE ENDODONTIC

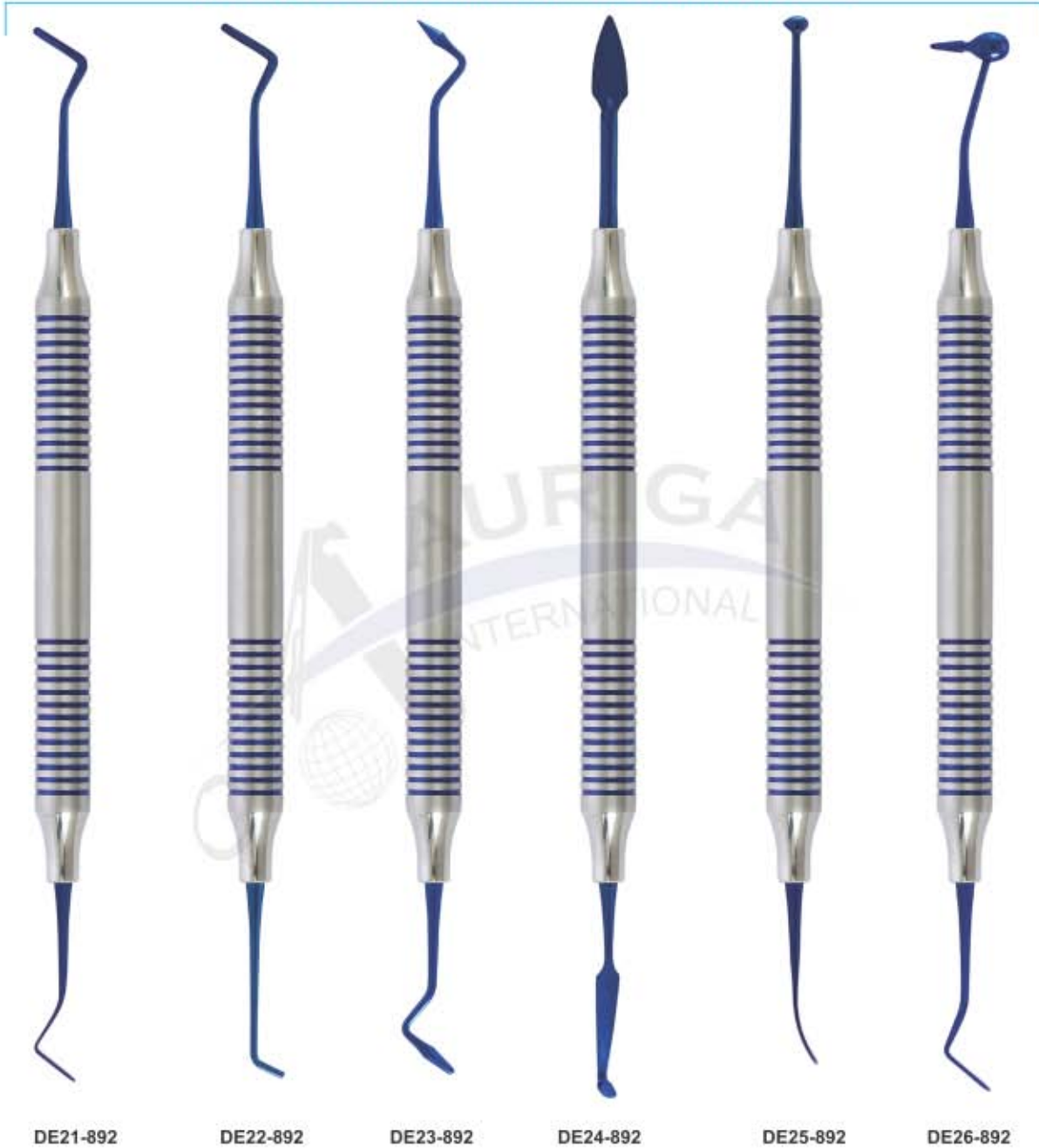

DE21-892

DE22-892

DE23-892

DE24-892

DE25-892

DE26-892



DE27-892  
Composite Instruments Blue  
Titanium with Cassettes



INCHES  
0 1 2 3 4 5 6 7 8 9 10 11 12 13 14 15 16 17 18 19

- Прочие товары
  - Divers produits et services
  - Sonstige Produkte
- Інші товари
  - Varios Productos
  - المنتجات المتنوعة



**DE28-892**  
X Ray Film Hangers



**DE29-892**  
X Ray Film Hangers



**DE30-892**  
X Ray Film Hangers



**DE31-892**  
X Ray Film Hangers



**DE32-892**  
X Ray Film Hangers



**DE33-892**  
X Ray Film Hangers



**DE34-892**  
X Ray Film Hangers



**DE35-892**



**DE36-892**



**DE37-892**



Dissecting Set  
**DE38-892** Set of 9 Pcs.  
**DE39-892** Set of 11 Pcs.



**DE40-892**  
Napkin Holder with Plastic Chain



**DE41-892**  
Napkin holder with metal chain



**Mouth Props DE42-892 Small**     **Mouth Props DE43-892 Medium**     **Mouth Props DE44-892 Large**

**Key Rings**



**DE45-892**



**DE46-892**



**DE47-892**



**DE48-892**



**DE49-892**



**DE50-892**

# FILLING INSTRUMENTS

- Инструменты для реставрации
- Instruments pour plombage
- Füllungsinstrumente (mit Kontrawinkel)
- Инструменти для реставрації
- Instrumentos para obturaciones
- ملء الصكوك

## CHISELS

## HOES



# CEMENT SPATULAS

- Шпатели для цемента
- Spatules à ciment
- Zementspatel

- Шпателі для цементу
- Espátulas para cemento
- ملاعق الأسمنت

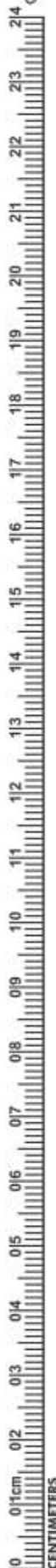

DE-893 00	DE-894 0	DE-895 1	DE-896 2	DE-897 3	DE-898 4	DE-899 3 Weston	DE-900 1 medium cement	DE-901 1											
DE-902 Le Cron	DE-903 Le Cron	DE-904 Le Cron	DE-905 MSY	DE-906 MSY	DE-907 Le Cron	DE-908 Hyllin	DE-909 Hyllin	DE-910 Hyllin	DE-911 Zahle	DE-912 Zahle	DE-913 Zahle	DE-914 Gritman							

# WAX KNIVES

- Ножи для воска
- Couteaux a cire
- Wachsmesser
- Ножи для воску
- Cuchillos para cera
- السكاكين الشمع

ALGINATE, PLASTER SPATULAS, WAX KNIVES PLASTER FOR KNIVES & PLASTER SHEAR



**DE-915**  
Wooden Handle  
Fig. 5  
21.5 cm



**DE-916**  
Wooden Handle  
Fig. 7  
19.5 cm curved



**DE-917**  
Wooden Handle  
Fig. 8  
20 cm curved



**DE-918**  
Wooden Handle  
Fig. 9  
22.5 cm curved



**DE-919**  
Hook Knives



**DE-920**  
Fig. 1  
Lessmann  
12.5 cm



**DE-921**  
Fig. 2  
Lessmann  
17 cm



**DE-922**  
Fig. 1  
with small spoon  
12.5 cm



**DE-923**  
Fig. 2  
with large spoon  
17 cm



**DE-924**  
Bacolite Handle  
Wax Knives,  
Small



**DE-925**  
Bacolite Handle  
Wax Knives,  
Large



**DE-926**  
Wooden Handle  
Wax Knives,  
Small



**DE-927**  
Wooden Handle  
Wax Knives,  
Large



**DE-928**  
Plaster Knife



**DE-929**  
Fig. 1  
17 cm



**DE-930**  
Fig. 3  
16 cm



**DE-931**  
Fig. 4  
16 cm



**DE-932**  
Special Inox  
19.5 cm



- Артикуляторы
- Artocilar
- Artikulations

- Артикулятори
- Articulere
- ارتیکولاتورس



**DE-933**

**Technical Datas:**

Intercondylar distance	120 mm.
condylar inclination	fixed at 30°
Bennet angle	fixed at 7°
Incisal table inclination	10°
Distance between mounting plates	85 mm.
Weight	400 gr.
Opening (item 5000)	125°
Opening (item 5010)	180°



**DE-934**

**Technical Datas:**

Intercondylar distance	110 mm.
condylar inclination	fixed at 30°
Bennet angle	fixed at 7°
Incisal table inclination	flat
Distance between mounting plates	85 mm.
Weight	450 gr.
Opening	180°



**DE-935**

Stainless Steel Finishing  
**DE-936**  
Royal Blue

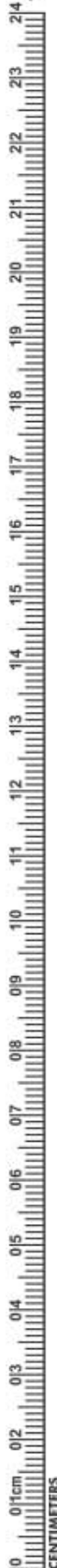

**DE-937**



**DE-938**



**DE-939**



**DE-940**



**DE-941**



**DE-942**



**DE-943**



**DE-944**



**DE-945**



**DE-946**  
Nakawalni  
Dental Laboratory  
Instrument

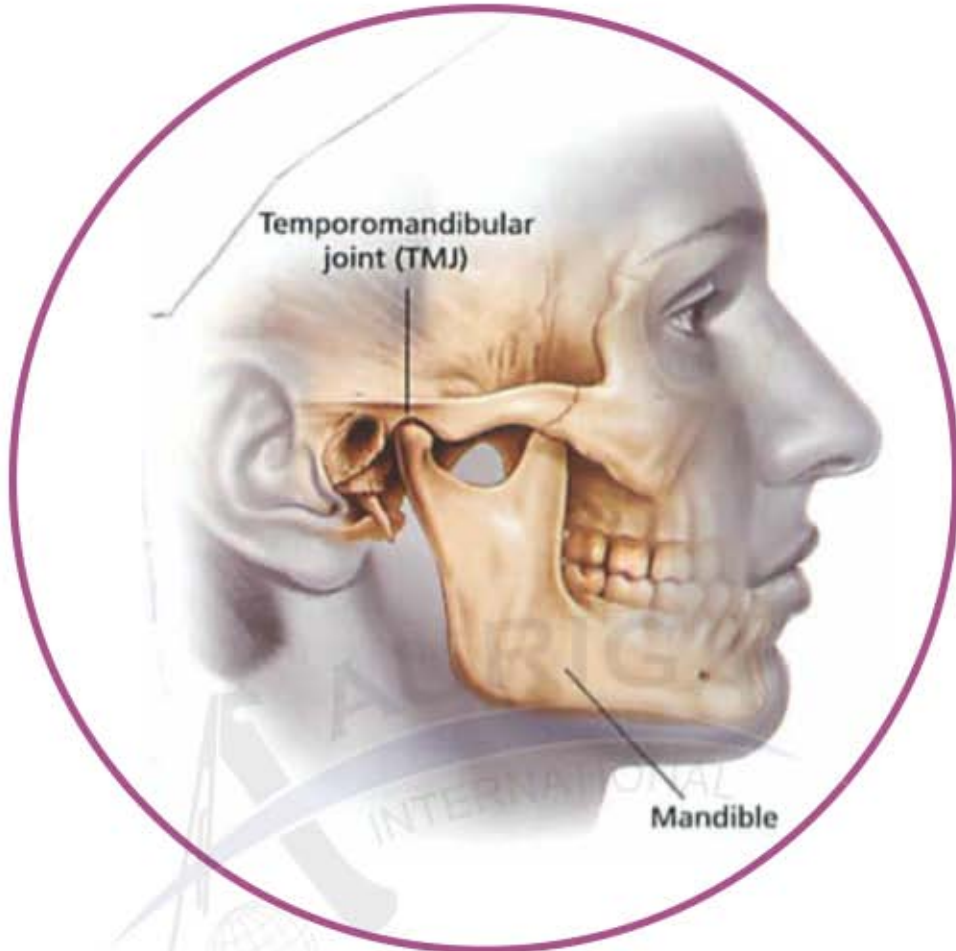

## RETRACTORS - MOUTH GAGS

- Роторасширители
- Ecarteurs - Ouvre-bouches
- Vestibulumabhalter / Mundspanner
- Роторозширювачі
- Separadores - Abre-bocas
- الكاشحات، الكاشحات الفم



**DE-947**  
Mouth Gag Molt  
11 cm for (Children)



**DE-948**  
Mouth Gag Molt  
14 cm for (Adults)



**Cheek Retractor**  
**DE-949** 140 mm  
**DE-950** 180 mm



**Cheek Retractor**  
**DE-951** 140 mm



**DE-952**  
Wangen Holder,  
vestibule  
15 cm, with or without  
lip protection,



**DE-953**  
Wangen Holder,  
vestibule 15 cm, with  
or without lip protection,



**DE-954**  
Wangen Holder  
Wangen holder with dual  
function, 17 cm,



**DE-955**  
140 mm

**DE-956**  
150 mm

**Cheek Retractor**

24  
23  
22  
21  
20  
19  
18  
17  
16  
15  
14  
13  
12  
11  
10  
09  
08  
07  
06  
05  
04  
03  
02  
01cm  
CENTIMETERS

# RETRACTORS - MOUTH GAGS

- Роторасширители
- Ecarteurs - Ouvre-bouches
- Vestibulumabhalter / Mundspanner
- Роторозширювачі
- Separadores - Abre-bocas
- الكاشطات، الكاشطات الفم



**DE-957**  
Fig. 1  
weitlander  
10.5cm  
13.5cm



**DE-958**  
Fig. 2  
weitlander  
10.5cm  
13.5cm



**DE-959**  
Stainless Steel  
Double  
Ended Cheek  
Retractors



**DE-960**  
Stainless Steel  
Single  
Ended Cheek  
Retractors



**DE-961** Weitlander 11cm  
**DE-962** 13cm  
**DE-963** 15cm



**DE-967**  
Denhard  
12 cm



**DE-968**  
Roser-König  
16 cm



**DE-969**  
Roser-König  
19 cm



**DE-964** Jennings 11cm  
**DE-965** 13cm  
**DE-966** 15cm



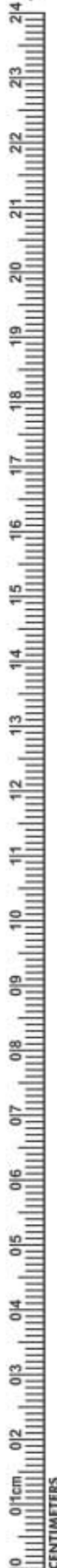

**Wound, Bendable**  
Retractor, individually or as saving kit!

- Ранорасширители
- Ecarteurs
- Wundhaken

- Ранорозширювачі
- Separadores
- الكاشطات



**DE-970**  
Cheek Retractor  
Long



**DE-971**  
Cheek Retractor  
Long



**DE-972**  
Cheek Retractor  
Long



**Retractor with Ergo Grip DE-973** 24 cm, ergonomic handle,



**DE-974**  
Cheek Retractors,  
Retractor Ivory  
Width adjustable & fixable, 20 cm,



**Cheek Retractors, tongue depressors DE-975** 19 cm



**Cheek Retractors, Minnesota DE-976** 16 cm



**Cheek Retractors, DE-977** 20 cm easy to bend by hand,



**Cheek Retractors, retractor and tongue pushers BISHOP DE-978** 16 cm,



**Retractors Cheek retractor combination DE-979** 25 cm,

# RETRACTORS

- Ранорасширители
- Ecarteurs
- Wundhaken
- Ранорозширювачі
- Separadores
- الكاشطات



**DE-982**  
Retractors, Unique  
Length 175 mm,  
angled 45 °



**DE-983**  
Retractors, Unique  
Length 175 mm,  
angled 90°



**DE-984**  
Retractors  
16cm



**DE-985**  
Retractors  
19cm



**DE-986**  
Retractors, Mini-Langenbeck  
16 cm, hooks 22 mm,



**DE-987**  
Retractors, Cheek  
retractors combination  
21 cm, 2



**DE-988**  
Mini Retractor  
about 8 cm,



**DE-989**  
Retractors  
17 cm, hooks 22 mm



- Ранорасширители
  - Ecarteurs
  - Wundhaken
- Ранорозширювачі
  - Separadores
  - الكاشطات



**DE-990**  
Retractors, surgical-flat  
surgically-flat, 21 cm, hook  
30x16 mm,



**DE-991**  
Retractors, surgical-flat  
surgically-flat, 21 cm, hook  
42x11 mm



**DE-992**  
Retractors, surgical-flat  
surgically-flat, 21 cm, hook  
63x12 mm,



Retractors, surgical-flat  
surgically-flat, 21 cm, hook  
**DE-993** 30x16 mm,  
**DE-994** 42x11 mm,  
**DE-995** 63x12 mm,



Retractors, Langenbeck  
21 cm, hook  
**DE-996** 30x11 mm  
**DE-997** 30x16 mm,



**DE-998**  
Retractors  
21 cm,



**DE-999**  
Farabeuf  
(120 X 12mm  
Set of 2 pices)



**DE-1000**  
Retractor Seldin



**DE-1001**  
FELDMAN  
RETRACTOR  
5-1/2", 14cm



# GUM SCISSORS

- Ножницы десневые
- Ciseaux a gencives
- Zahnfleischscheren
- Ножиці для ясен
- Tijeras para encias
- مقص صمغ



**DE-1002**  
Iris  
115mm  
Straight



**DE-1003**  
Iris  
115mm  
Curved



**DE-1004**  
Goldman-Fox  
130mm  
Saw edge, straight



**DE-1005**  
Goldman-Fox  
130mm  
Saw edge, Curved



**DE-1006**  
La Grange  
115mm  
Saw edge, double Curved



Mayo  
**DE-1007** 140mm  
**DE-1008** 170mm  
**DE-1009** 230mm  
Straight



Mayo  
**DE-1010** 140mm  
**DE-1011** 170mm  
**DE-1012** 230mm  
Curved



Metzenbaum  
**DE-1013** 145mm  
**DE-1014** 180mm  
**DE-1015** 200mm  
Straight



Metzenbaum  
**DE-1016** 145mm  
**DE-1017** 180mm  
**DE-1018** 200mm  
Curved



**DE-1019**  
Kelly  
160mm  
Straight



**DE-1020**  
Kelly  
160mm  
Curved



**DE-1021**  
Iris  
115mm  
Straight



**DE-1022**  
Iris  
115mm  
Curved



**DE-1023**  
La Grange  
115mm  
Double Curved



**DE-1024**  
Goldman-Fox  
130mm, Straight



**DE-1025**  
Goldman-Fox  
130mm, Curved



**DE-1026**  
Kelly  
160mm, Curved



**DE-1027**  
Iris  
115mm, Straight



**DE-1028**  
Iris  
115mm, Curved



**DE-1029**  
Micro Iris  
90mm, Curved



- Ножницы десневые
- Ciseaux a gencives
- Zahnfleischscheren

- Ножиці для ясен
- Tijeras para encias
- مقص صمغ



**DE-1030**  
Iris  
115mm  
Angled



**DE-1031**  
Iris  
115mm  
Curved



**DE-1032**  
Goldman-Fox  
130mm  
Saw edge,  
straight



**DE-1033**  
Goldman-Fox  
130mm  
Saw edge,  
curved



**DE-1034**  
Goldman-Fox  
130mm  
Saw edge,  
double curved



**DE-1035**  
La Grange  
115mm  
Saw edge,  
double curved



**DE-1036**  
Neumann  
120mm  
Saw edge,  
double curved



**DE-1037**  
Kilner (Ragnell)  
120mm  
Straight



**DE-1038**  
Kilner (Ragnell)  
120mm  
Curved



**DE-1039**  
Joseph  
140mm  
Straight



**DE-1040**  
Joseph  
140mm  
Curved



**DE-1041**  
Kelly  
160mm  
Straight



**DE-1042**  
Kelly  
160mm  
Curved



**DE-1043**  
Locklin  
160mm  
Saw edge,  
angular



**DE-1044**  
Locklin  
120mm  
160mm  
Saw edge,  
angular



**DE-1045**  
Dean  
170mm  
Saw edge,  
angular



**DE-1046**  
Spencer  
90mm



**DE-1047**  
Spencer  
130mm



**DE-1048**  
Spencer  
115mm



**DE-1049**  
Noyes  
110mm, Straight



**DE-1050**  
Noyes  
110mm  
Curved



**DE-1051**  
Noyes  
110mm  
Angular



**DE-1052**  
Castroviejo  
150mm  
Curved

# NEEDLE HOLDERS

- Иглодержатели
- Porte-aiguilles
- Nadelhalter
- Голкотримачи
- Porta-agujas
- اصحاب ابرة



**DE-1053**  
130mm  
Straight



**DE-1054** Mayo  
**DE-1055** Mayo  
**DE-1056** Mayo  
130mm 130mm  
160mm 160mm  
180mm 180mm  
Straight Curved



**DE-1057** Mayo  
**DE-1058** Mayo  
140mm 140mm  
200mm 200mm  
Straight Curved



**DE-1059** Metzenbaum  
**DE-1060** Metzenbaum  
145mm 145mm  
200mm 200mm  
Straight Curved



**DE-1061** Beebee  
110mm  
Saw edge,  
straight



**DE-1062** Beebee  
110mm  
Saw edge,  
curved



**DE-1063** Beebee  
110mm  
Saw edge, straight



**DE-1064** Beebee  
110mm  
Saw edge, curved

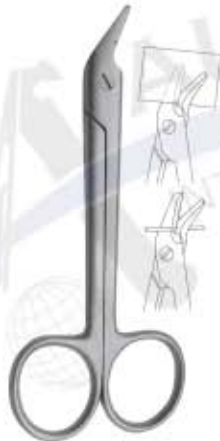

**DE-1065** Universal  
120mm  
Saw edge



**DE-1066** Universal  
120mm



**DE-1067** Crile 130mm  
**DE-1068** Crile 150mm  
**DE-1069** Crile 180mm



**DE-1070** Halsey  
130mm



**DE-1071** Baumgartner  
130mm



**DE-1072** Derf  
120mm



**DE-1073** Delicate  
150mm



**DE-1074** Mayo-Hegar 130mm  
**DE-1075** Mayo-Hegar 160mm  
**DE-1076** Mayo-Hegar 180mm  
**DE-1077** Mayo-Hegar 200mm



**DE-1078** Crile-Wood  
150mm  
straight



**DE-1079** Crile-Wood  
150mm  
curved



## NEEDLE HOLDERS

- Иглодержатели
- Porte-aiguilles
- Nadelhalter

- Голкотримачи
- Porta-agujas
- اصحاب ابرة



Castroviejo  
DE-1080 130mm  
DE-1081 150mm  
DE-1082 180mm



DE-1083  
Halsey  
130mm



DE-1084  
Baumgartner  
130mm



DE-1085  
Derf  
120mm



DE-1086  
Delicate  
150mm



DE-1087  
Adson  
170mm



Mayo-Hegar  
DE-1088 130mm  
DE-1089 160mm  
DE-1090 180mm  
DE-1091 200mm



DE-1092  
Crile-Wood  
150mm



Castroviejo  
DE-1093 str 140mm cvd  
DE-1094 str 180mm cvd



Olsen-Hegar Needle  
Holder With Scissors  
DE-1095 140mm



Gillies Needle  
Holder With Scissors  
DE-1096 160mm



Mathieu  
DE-1097 140mm  
DE-1098 170mm



Castroviejo  
DE-1099 str 140mm cvd  
DE-1100 str 180mm cvd



Olsen-Hegar Needle  
Holder With Scissors  
DE-1101 140mm



Gillies Needle  
Holder With Scissors  
DE-1102 160mm

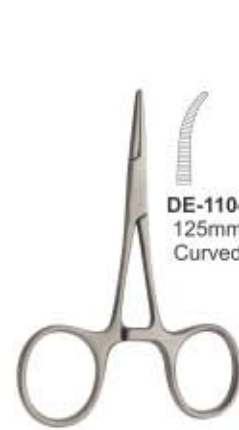

Hartmann (Baby  
Mosquito)  
DE-1103 90mm straight



Halstead Mosquito  
DE-1105 125mm  
Straight

DE-1106  
Curved

24  
23  
22  
21  
20  
19  
18  
17  
16  
15  
14  
13  
12  
11  
10  
09  
08  
07  
06  
05  
04  
03  
02  
01  
0  
CENTIMETERS

# HAEMOSTATIC FORCEPS & TOWEL CLAMPS

- Зажимы артериальные, зажимы для салфеток
- Pinces hemostatiques, Pincas a compresas
- Arterienklemmen, Tuschklammen
- Затискачі артеріальні, затискачі для серветок
- Pinzas hemostaticas, Pincas para compresas
- الملقط هيموستاتيک المشبك منشفة



Halstead Mosquito 1x2  
DE-1107 125mm  
straight



Kelly  
DE-1109 140mm  
straight



Rochester-Pean  
DE-1111 140mm  
DE-1112 160mm  
DE-1113 180mm  
DE-1114 200mm  
straight

DE-1115 140mm  
DE-1116 160mm  
DE-1117 180mm  
DE-1118 200mm  
curved



Rochester-Kocher 1x2  
DE-1119 140mm  
DE-1120 160mm  
DE-1121 180mm  
DE-1122 200mm  
straight

DE-1123 140mm  
DE-1124 160mm  
DE-1125 180mm  
DE-1126 200mm  
curved



DE-1127  
Kelly-Rankin  
160mm  
straight



Lorna  
DE-1129 100mm  
DE-1130 130mm



DE-1131  
Allis-Baby 3:4  
150mm



DE-1132  
Allis 4:5  
200mm



DE-1133  
Allis 6:7  
200mm



Backhaus  
DE-1134 140mm  
Not-perforating and  
not-damaging



DE-1135  
Backhaus  
130mm



DE-1136  
Backhaus  
85mm



DE-1137  
Jones  
90mm



DE-1139  
curved

Gross Maier  
Dressing Forceps  
DE-1138 200mm straight



Foerster  
Dressing Forceps  
DE-1140 200mm



Spare rubber

Young  
Tongue Forceps  
DE-1141 170mm



Collins  
Tongue Forceps  
DE-1142 170mm



# RUBBER DAM CLAMPS FORCEPS

- Инструменты для системы коффердам
- Pincas porte-crampons a digue
- Kofferdam Klammerzangen
- Инструменты для системи коффердам
- Pinzas de engrapar para dique de caucho
- المد المطاط الملقط المشابك



### DE-1143

On request the Content of the rubber dam kit can be changed with other instruments.

#### Content:

- 01 Anisworth
- 02 Brewer
- 03 Clamps Stand
- 04 Denture Plate
- 05 Rubber Dam Frame
- 06 Rubber Dam Box Lower Case
- 07 Rubber Dam Box Upper Case
- 08 Rubber Dam Clamp Fig. 212
- 09 Rubber Dam Clamp Fig. 211
- 10 Rubber Dam Clamp Fig. 8
- 11 Rubber Dam Clamp Fig. 8A
- 12 Rubber Dam Clamp Fig. 14
- 13 Rubber Dam Clamp Fig. 14A
- 14 Rubber Dam Clamp Fig. 0
- 15 Rubber Dam Clamp Fig. 00
- 16 Rubber Dam Clamp Fig. 2
- 17 Rubber Dam Clamp Fig. 2A
- 18 Rubber Dam Clamp Fig. 7



**DE1-1143**  
Small  
Rubber Dam  
Frame

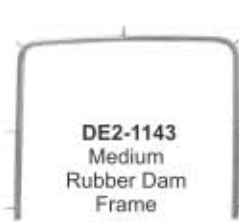

**DE2-1143**  
Medium  
Rubber Dam  
Frame



**DE3-1143**  
Large  
Rubber Dam  
Frame



**DE-1145**  
Brewer



**DE1-1145**  
Stockes



**DE-1147**  
Palmer



**DE-1146**  
Ivory light weight



**DE-1144**  
Anisworth



**DE1-1144**  
Anisworth



Punch Plier



**DE2-1144**  
Anisworth



**DE3-1144**  
Ivory



**DE-1148**  
Separating  
Elastic Plier



# RUBBER DAM CLAMPS

- Кляммера для коффердама
- Crampons pour digue
- Kofferdam Klammern
- Кляммера для коффердама
- Grapas para dique de caucho
- المشابك المد المطاط



DE-1149  
Fig. 15



DE-1150  
Fig. 18



DE-1151  
Fig. 24



DE-1152  
Fig. 25



DE-1153  
Fig. 26



DE-1154  
Fig. 28



DE-1155  
Fig. 30



DE-1156  
Fig. 31



DE-1157  
Fig. 51



DE-1158  
Fig. 138



DE-1159  
Fig. 139



DE-1160  
Fig. 200



DE-1161  
Fig. 201



DE-1162  
Fig. 202



DE-1163  
Fig. 203



DE-1164  
Fig. 204



DE-1165  
Fig. 205



DE-1166  
Fig. 3



DE-1167  
Fig. W3



DE-1168  
Fig. 4



DE-1169  
Fig. 56A



DE-1170  
Fig. 7



DE-1171  
Fig. 7A



DE-1172  
Fig. 8



DE-1173  
Fig. 8A



DE-1174  
Fig. W8A



DE-1175  
Fig. 10



DE-1176  
Fig. 11



DE-1177  
Fig. 12A



DE-1178  
Fig. 13A



DE-1179  
Fig. 14



DE-1180  
Fig. 14A



DE-1181  
Fig. 14AN



DE-1182  
Fig. 22



DE-1183  
Fig. 27



DE-1184  
Fig. 207



DE-1185  
Fig. 29



DE-1186  
Fig. 206



DE-1187  
Fig. 208



DE-1188  
Fig. 209



DE-1189  
Fig. 1



DE-1190  
Fig. 1A



DE-1191  
Fig. 2



DE-1192  
Fig. 2A



DE-1193  
Fig. W2A



DE-1194  
Fig. 0



DE-1195  
Fig. 00



DE-1196  
Fig. 210



DE-1197  
Fig. 211



DE-1198  
Fig. 212



DE-1199  
Fig. 6



DE-1200  
Fig. 9



DE-1201  
Fig. N06



DE-1202  
Fig. U67



DE-1203  
Fig. 214



DE-1204  
Fig. P1



DE-1205  
Fig. P2



DE-1206  
Fig. G-1



DE-1207  
Fig. G-2



- Инструменты для удаления коронок
  - Attache-couronnes
  - Teleskopkronenzangen
- Инструменты для видалення коронок
  - Attanca-corona
  - مزيلات التاج

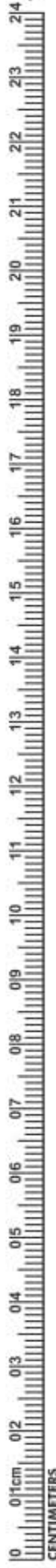

**DE-1210**  
Crown Spreaders



**DE-1211**  
Mershon  
14 cm  
Band Pusher



**DE-1212** Manual Crown Removers  
Fig. 0 Handle with 3 tips **DE1-1212**  
Only 3 tips **DE2-1212 to DE4-1212**



DE2-1212



DE3-1212



DE4-1212



DE6-1212



DE7-1212



DE8-1212



Manual Crown Removers  
Handle with 3 tips **DE5-1212**  
Only 3 tips **DE6-1212 to DE8-1212**



**DE-1213**  
Manual Crown Remover



**DE-1214**  
Complete with 3 tips  
and tightening keys



A



B



C  
semi-automatic crown  
& bridge remover



D



**DE-1215**



**DE-1216**  
Manual Crown Remover



# MATRIX RETAINERS

- Матрицедержатели
- Porte Matrices
- Matrizenspanner
- Матрицеутримувачи
- Porta Matrices
- مصفوفة الخدم



**DE-1217**  
Fig. 5  
Ivory 8  
5 cm



**DE-1218**  
Fig. 6  
Ivory 8  
6 cm



**DE-1219**  
Fig. 7  
Ivory 8  
7 cm



**DE-1220**  
Fig. 1  
Tofflemire-Universal



**DE87-1220**



**DE1-1220**



**DE2-1220**

## Siqveland Retainers



**DE-1221**  
Fig. 2  
Tofflemire-Junior



**DE-1222**  
Fig. 3  
Tofflemire-Senior



**DE-1223**  
Narrow



**DE-1224**  
Wide

## Amalgam Well



**DE-1225**  
Stainless Steel  
Amalgam Well



**DE-1226**  
Ivory 12



**DE-1227**  
Ivory 1



**DE-1228**  
Ivory



**DE-1229**  
Elliot



## AMALGAM INSTRUMENTS & SCALPEL HANDLES

Инструменты для амальгамы  
 • Instruments pour amalgame  
 • Amalgamis/instrumente

• Инструменти для амальгами  
 • Instrumentos para amalgama  
 • الصوك الملعف

• Ручки для скальпелей  
 • Manches de bistouris  
 • Skalpellgriffe

• Ручки для скальпелів  
 • Mangos de bisturi  
 • مشرط مقابض

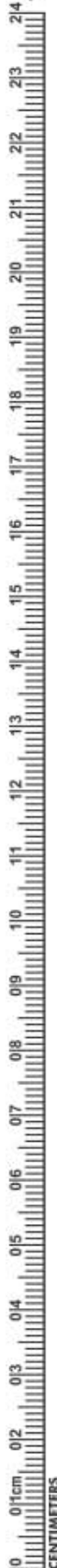

Ø 2mm

**DE-1230**  
 Fig. 10  
 165mm  
 English pattern



Ø 2mm

**DE-1231**  
 Fig. 1  
 185mm  
 German pattern



Ø 2mm

**DE-1232**  
 Fig. 1  
 150mm  
 Swiss pattern



Ø 2mm

**DE-1233**  
 Fig. 1  
 150mm



Ø 2mm

**DE-1234**  
 Fig. 2  
 150mm, 45°



Ø 2mm

**DE-1235**  
 Fig. 3  
 140mm, 90°



**DE-1236**  
 Fig.3  
 5" (12.7cm)



**DE-1237**  
 Fig.3G  
 5" (12.7cm)



**DE-1238**  
 Fig.4  
 5 1/2" (13.7cm)



**DE-1239**  
 6 Way Adjustable Angled  
 Scalpel Handle



Locks At 90°, 60°, 30°,  
 Straight, 120°, 150°, 180°,  
 Angles

# AMALGAM INSTRUMENTS

- Инструменты для амальгамы
- Instruments pour amalgame
- Amalgamis/Instrumente
- Инструменти для амальгами
- Instrumentos para amalgama
- الصكوك الملعف

## AMALGAM CARRIERS

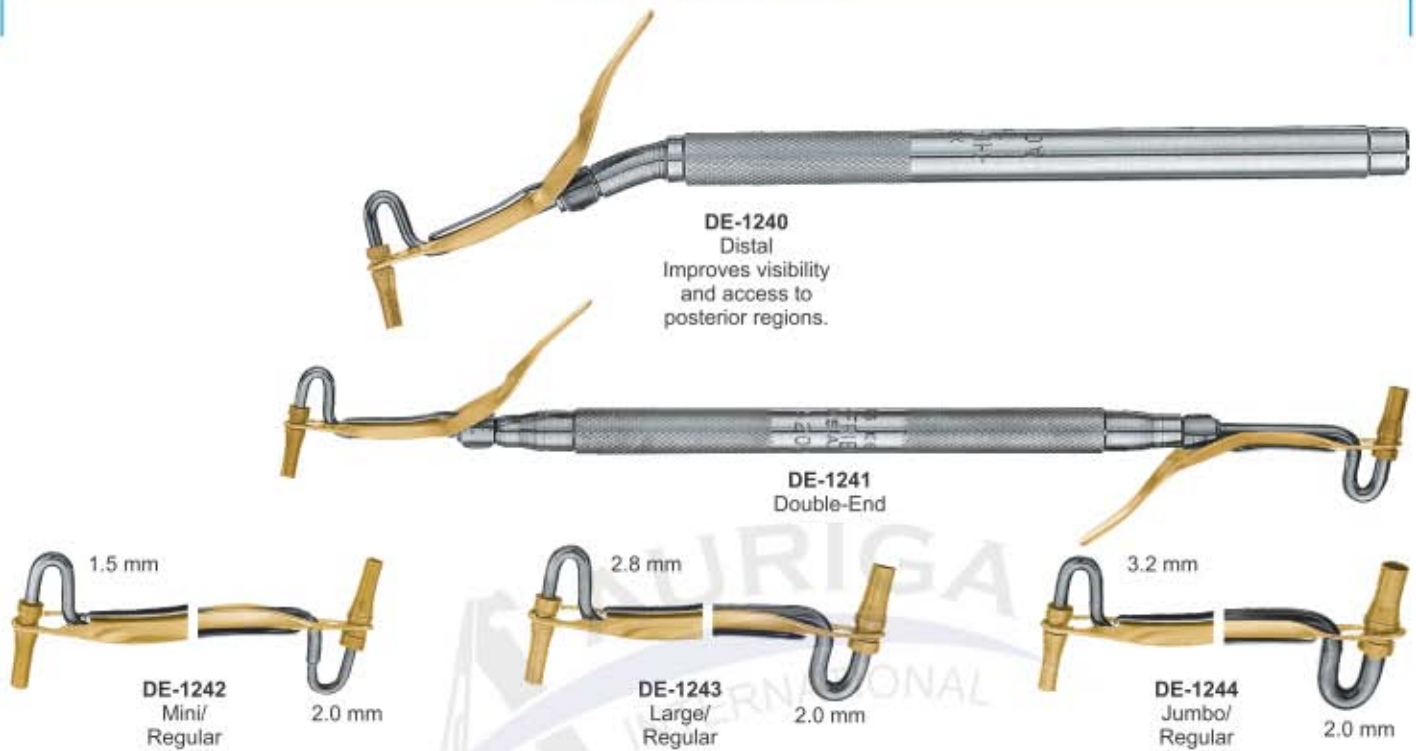

### TIP SIZES FOR DOUBLE-END



**DE-1251**  
Amalgam  
Well



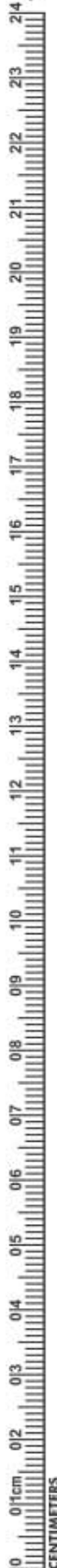

**ROOT PLANNING FILES**



**DE-1252**  
Kramer-Nevis  
Bone Chisel



**DE-1253**  
Kramer-Nevis  
Bone Chisel



**DE-1254**  
Molt 18.5cm  
Auto Clavable  
Plastic Tips.



**DE-1255**  
Mead 18.5cm  
Non Auto Clavable  
Plastic Tips.



**DE-1256**  
Miller



**DE-1257**  
Miller

**BONE FILES**



**DE-1258**  
Miller 21



**DE-1259**  
Miller 1X  
cross cut



**DE-1260**  
Miller 2X  
cross cut



**DE-1261**  
Miller 52



**DE-1262**  
Wahl 1

# PERIODONTAL INSTRUMENTS

- Инструменты пародонтологические
- Instruments pour la parodontologie
- Instrumente für die Parodontologie
- Инструменти пародонтологічні
- Instrumentos para periodoncia
- الصكوك اللثة

## PERIOSTEEL ELEVATORS





Behind Every Smile is a Story

- QUALITY - ЯКІСТЬ
- PRECISION - ТОЧНІСТЬ
- ACCURACY - ПРАВИЛЬНІСТЬ
- DURABILITY - ЗНОСОСТІЙКІСТЬ



**STYLE A**

- Super-sharp diamond-bevel cutters
- smooth ultra-polished end occlusal edges
- behave consistent resistant stainless steel finish
- superior T12 stainless steel and inserts
- sliding lock joint for balance & precision alignment

**STYLE B**

- Super-sharp diamond-bevel cutters
- smooth ultra-polished end occlusal edges
- brilliant consistent resistant stainless steel finish
- superior T12 stainless steel and inserts
- sliding lock joint for balance & precision alignment

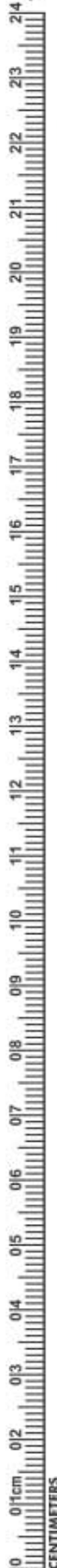

# ORTHODONTIC INSTRUMENTS

- Инструменты ортодонтические
- Instrumentos Ortodonticos
- Orthodontische Instrumente
- Инструменти ортодонтични
- Instruments Orthodontiques
- أدوات تقويم الأسنان



**DE-1277** Aluminum Height Gauge 0.22  
**DE-1278** Aluminum Height Gauge 0.18  
**DE1-1278** Height Gauge Movable



**DE-1279** Bone Bracket Gauge



**DE1-1279** Endo Finger Ruler Span Measure Scale



**DE2-1279** Endo Finger Ruler Span Measure Scale



**DE3-1279** Endo Finger Ruler Span Measure Scale



**DE4-1279** Compasso De Willis



**DE-1280** Bone Thickness Gauge 40mm, 180mm



**DE-1281** Osteometer Measuring Forceps



**DE-1282** Bracket Placer Tweezers (Extra Fine Tip)



**DE-1283** Direct Bonding Bracket Holders 135mm



**DE-1284** Direct Bonding Bracket Holders 136mm



**DE-1285** Direct Bonding Bracket Holders 135mm



**DE-1286** Deluxe Bracket Holder



**DE-1287** Deluxe Bracket Holder Tweezers



**DE-1288** Deluxe Bracket Holder Tweezers



**DE1-1288** Bracket Tweezers Slot Aligner



**DE2-1288** Direct Bonding Bracket Holders 140mm



**DE3-1288** Bracket Placing Tweezers



**DE4-1288** Easy Access Tweezers

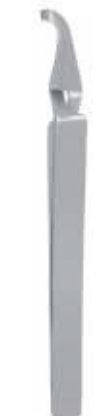

**DE5-1288** Direct Bonding Bracket Holders 140mm



**DE6-1288** Direct Bond Bracket Holder Tweezers Small Tip



**DE7-1288** Exact Bracket Holder Tweezers



**DE8-1288** Easy Access Tweezers



**DE9-1288** Slipper Tweezers



- Инструменты ортодонтические
- Instrumentos Ortodonticos
- Orthodontische Instrumente
- Инструменти ортодонтични
- Instruments Orthodontiques
- أدوات تقويم الأسنان



**DE-1289**  
Band seater auto cleavable



**DE-1290**  
Ortho light scaler double ended



**DE-1291**  
Ortho light scaler double ended



**DE-1292**  
Ortho light scaler double ended



**DE-1293**  
Twiel-on elastic module instrument



**DE-1294**  
Twiel-on elastic module instrument



**DE-1295**  
Schure Band Seater



**DE-1296**  
Ortho light scaler

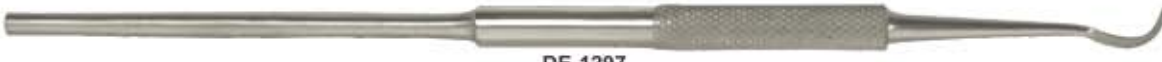

**DE-1297**  
Ortho light scaler

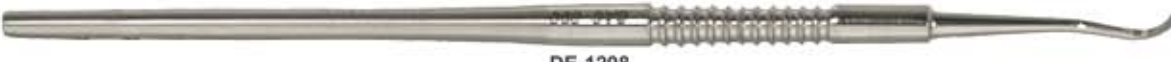

**DE-1298**  
Ortho light scaler heavy

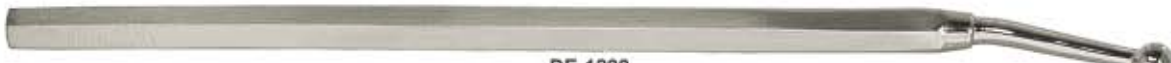

**DE-1299**  
Ortho instrument



**DE-1300**  
Ortho instrument



**DE-1301**  
Ortho Light Band Pusher Scaler

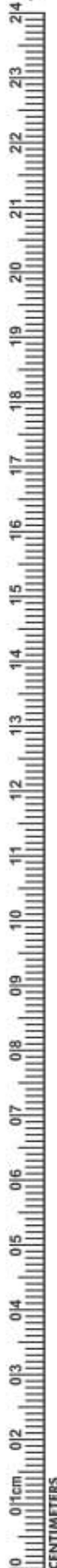

# ORTHODONTIC INSTRUMENTS

- Инструменты ортодонтические
- Instrumentos Ortodonticos
- Orthodontische Instrumente
- Инструменти ортодонтични
- Instruments Orthodontiques
- أدوات تقويم الأسنان



**DE-1302**  
Ortho Light double ended  
ligature director



**DE-1303**  
Ortho Light double ended  
ligature director scaler



**DE-1304**  
Ortho Light double ended ligature scaler director tivate coil spring  
are remove modules with one instruments



**DE-1305**  
Ortho band pusher scaler



**DE-1306**  
Ortho Light Band Pusher Scaler



**DE-1307**  
Ortho ligature director single ended



**DE-1308**  
Ortho Light double ended ligature  
director scaler



**DE-1309**  
Ortho Light double ended ligature scaler/director  
tivate coil spring are remove modules with one instruments



**DE-1310**  
Ortho Light double ended ligature director



**DE-1311**  
Ortholite Ligature Director Scaler



**DE-1312**  
Ortho light ligature director double ended



**DE-1313**  
Double ended cement spatula



**DE-1314**  
Ortho light scaler single ended



- Щипцы для ортодонтии и протезирования
- Pinces pour l'orthodontie et la prothèse
- Zangen für Kieferorthopädie und Prothetik
- Щипці для ортодонції та протезування
- Alicates para ortodoncia y prótesis
- كمشة لتقويم الأسنان برومشتيس

## BOX JOINT PLIERS

**DE-1315**  
Universal Dolphin Style  
Wire Bending & cutting pliers



**DE-1316 Band Removing Plier**  
The curved blade of the band removing plier can strip easily and gently remove directly to the tooth. Length 130mm



**DE-1317**  
Tweed Loop forming Pliers



**DE-1318**  
How Plier curved  
Universally usable tool for the multiband technology for wires up to .028". Length 130mm



**DE-1319 How Plier**  
Universally usable tool for the multiband technology for wires up to .028". Length 135mm



**DE-1320**  
Nance Loop forming Pliers



**DE-1321**  
Bracket Removing Plier curved  
Bracket Removing Plier curved for easy removal of brackets in the posterior region. Length 130mm



**DE-1322**  
Young Wire Bending & Loop Forming Pliers



**DE-1323**  
Wire Bending & Loop Forming Pliers



**DE-1324**  
Adams, small wire bending and loop forming Pliers



**DE-1325**  
Bracket Removing Plier Round Box  
Bracket removing plier for comfortable and quick removal of the brackets. Length 135mm



**DE-1326**  
Weingart Plier medium  
Weingart plier that are ideal due to their curved tip for setting sheets and is capable of bending the ends. Length 145mm



# PLIERS FOR ORTHODONTICS & PROSTHETICS

- Щипцы для ортодонтии и протезирования
- Pincers pour l'orthodontie et la prothèse
- Zangen für Kieferorthopädie und Prothetik
- Щипці для ортодонтії та протезування
- Alicates para ortodoncia y prótesis
- كمشاة لتقويم الأسنان بروتیثیس

## BOX JOINT PLIERS

### DE-1327 Adams Plier Round Box

Adams pliers for bending wire arches and bends right angles for wires up to .022", .025 tip to beak. Length 125mm



### DE-1333 Adams Plier

Adams pliers for bending wire arches and bends right angles for wires up to .022", .025 tip to beak. Length 125mm



### DE-1328

Falcon Beak Contouring Pliers.



### DE-1334

Tweed Loop Formin Pliers



### DE-1329

wires up to 0.020" / 0.7mm.



### DE-1335 Bird Beak Plier Standard

Bird Beak Wire bending plier without notches, which is suitable as a universal utility tool. Length 125mm



### DE-1330

Johnson Contouring Pliers



### DE-1336

Mini Ligature cutters



### DE-1331 Aderer

Large wire bending and loop forming pliers



### DE-1337 Small

Fluch-cut distal and cutting Pliers with safety hold fitted with un-breakable, corrosion resistant and durable stainless steel tips



### DE-1332

Tweed / angle rectangular arch forming & Torquing pliers



### DE-1338 Large

Fluch-cut distal and cutting Pliers with safety hold fitted with un-breakable, corrosion resistant and durable stainless steel tips



- Щипцы для ортодонтии и протезирования
- Pincers pour l'orthodontie et la prothèse
- Zangen für Kieferorthopädie und Prothetik

- Щипці для ортодонції та протезування
- Alicates para ortodoncia y prótesis
- كمامشة لتقويم الأسنان برومشتيس

## BOX JOINT PLIERS

DE-1339

**Tweed / Angel**

1.78mm (.070") wide tips arch forming and torquing pliers



DE-1345

**Contouring Plier**



DE-1340

**Tweed / Angel**

1.78mm (.070") wide tips arch forming and torquing pliers



DE-1346

**Bands & Crowns Plier**  
in order to skirt



DE-1341

**Lingual / Palatal arch**  
forming pliers



DE-1347

**Ligature Forming Pliers**



DE-1342

**Aderer**

Facebow loop forming Pliers



DE-1348

for double back and triple back bands in 0.30" / 0.76mm & 0.36" / 0.91mm lingual arch wires



DE-1343

Waldsavhs wire bending and cutting pliers



DE-1349

**Bird Beak Wire Bending & cutting pliers**



DE-1344 **Aderer Plier**

For the manufacturing of appliances and activation of wires for wires up to .030" .fine tip and up to .036" mean tip. Length 130mm



DE-1350

**Weingart Plier medium**

Weingart plier that are ideal due to their curved tip for setting sheets and is capable of bending the ends. Length 145mm



# PLIERS FOR ORTHODONTICS & PROSTHETICS

- Щипцы для ортодонтии и протезирования
- Pincers pour l'orthodontie et la prothèse
- Zangen für Kieferorthopädie und Prothetik
- Щипці для ортодонції та протезування
- Alicates para ortodoncia y prótesis
- كمامة لتقويم الأسنان بروسثيتيس

## L-KEY JOINT PLIERS



**DE-1351**  
Distal end cutter with safety hold, mini head, long handles.  
fitted with un-breakable, corrosion resistant and durable stainless steel tips

- 0.30 mm to 0.50 mm (.012" to .020")
- Max. 0.46 mm x 0.64 mm (.018" x .025")
- ⊗ 0.38 mm to 0.53 mm (.0155" to .0215")
- ⊗ Max. 0.53 mm x 0.64 mm (.021" x .025")



**DE-1352**  
Flush-cut distal end cutter with safety hold fitted with un-breakable, corrosion resistant and durable stainless steel tips

- 0.30 mm to 0.50 mm (.012" to .020")
- Max. 0.46 mm x 0.64 mm (.018" to .025")



**DE-1353**  
Soft wire and ligature cutter, Mini fitted with un-breakable, corrosion resistant and durable stainless steel tips

- ☞ .25 mm to .38 mm (.010" to .015")



**DE-1354**  
Soft wire and ligature cutter, standard fitted with un-breakable, corrosion resistant and durable stainless steel tips

- ☞ .25 mm to .38 mm (.010" to .015")



**DE-1355**  
Soft wire and ligature cutter, 15° angled fitted with un-breakable, corrosion resistant and durable stainless steel tips

- ☞ .25 mm to .38 mm (.010" to .015")



**DE-1356**  
Soft wire and ligature cutter, 45° angled fitted with un-breakable, corrosion resistant and durable stainless steel tips

- ☞ .25 mm to .38 mm (.010" to .015")



**DE-1357**  
Hard wire cutter, straight Fitted with un-breakable, corrosion resistant and durable stainless steel tips

- 0.30 mm to 0.50 mm (.012" to .020")
- Max. 0.56 mm x 0.71 mm (.022" x .028")



**DE-1358**  
Hard wire cutter, 15° angled Fitted with un-breakable, corrosion resistant and durable stainless steel tips

- 0.30 mm to 0.50 mm (.012" to .020")
- Max. 0.56 mm x 0.71 mm (.022" x .028")



**DE-1359**  
Hard wire cutter, 15° angled Non-autoclavable

- 0.30 mm to 0.50 mm (.012" to .020")
- Max. 0.56 mm x 0.71 mm (.022" x .028")



- Щипцы для ортодонтии и протезирования
- Pincers pour l'orthodontie et la prothèse
- Zangen für Kieferorthopädie und Prothetik

- Щипці для ортодонції та протезування
- Alicates para ortodoncia y prótesis
- كمانشة لتقويم الأسنان برومشتيس

## L-KEY JOINT PLIERS



**DE-1360**  
Band removing pliers



**DE-1365**  
Weingart-mini  
Utility Pliers

- 0.30 mm to 0.50 mm (.012" to .020")
- Max 0.56 mm x 0.71 mm (.022" x .028")



**DE-1361**  
Bracket removing pliers angled



**DE-1366**  
Weingart  
Utility Pliers

- 0.30 mm to 0.50 mm (.012" to .020")
- Max 0.56 mm x 0.71 mm (.022" x .028")



**DE-1362**  
Bracket removing pliers straight



**DE-1367**  
How Straight  
Utility Pliers

- 0.30 mm to 0.50 mm (.012" to .020")
- Max 0.56 mm x 0.71 mm (.022" x .028")



**DE-1363**  
Bracket removing pliers with plastic tip



**DE-1368**  
Angled  
Utility Pliers

- 0.30 mm to 0.50 mm (.012" to .020")
- Max 0.56 mm x 0.71 mm (.022" x .028")



**DE-1364**  
Adhesive removing pliers



**DE-1369**  
Wire bending and loop forming pliers  
Angled (Bird beak)

- 0.30 mm to 0.50 mm (.012" to .020")
- Max 0.56 mm x 0.71 mm (.022" x .028")

# PLIERS FOR ORTHODONTICS & PROSTHETICS

- Щипцы для ортодонтии и протезирования
- Pincers pour l'orthodontie et la prothèse
- Zangen für Kieferorthopädie und Prothetik
- Щипці для ортодонції та протезування
- Alicates para ortodoncia y prótesis
- كمامشة لتقويم الأسنان برومبوتيس

## L-KEY JOINT PLIERS



**DE-1370**  
Multi-purpose pliers, bird beak,  
De la rosa and cutter in one

- 0.30 mm to 0.50 mm (.012" to .020")
- Max. 0.46 mm x 0.56 mm (.018" x .022")



**DE-1375**  
Stop pliers V-Bebd - 1mm

- 0.30 mm to 0.50 mm (.012" to .020")
- Max. 0.43 mm x 0.56 mm (.017" x .028")



**DE-1371**  
Cinch Back / tie back  
Distal end bending pliers

- 0.30 mm to 0.50 mm (.012" to .020")
- Max. 0.56 mm x 0.71 mm (.022" x .028")



**DE-1376**  
Lingual / palatal arch forming plies

- 0.76 mm (.030") / 0.91 mm (.036")



**DE-1372**  
Hammer head  
Distal end bending pliers

- 0.30 mm to 0.50 mm (.012" to .020")
- Max. 0.56 mm x 0.71 mm (.022" x .028")



**DE-1377**  
Torquing pliers set



**DE-1373**  
Nance  
Loop forming pliers

- 0.36 mm to 0.71 mm (.014" to .028")
- Max. 0.56 mm x 0.71 mm (.022" x .028")



**DE-1378**  
Tweed / angel  
Rectangular arch forming and  
torquing pliers

- 0.30 mm to 0.71 mm (.012" to .028")
- Max. 0.56 mm x 0.71 mm (.022" x .028")



**DE-1374**  
Detailing step pliers / Bayonet  
bending pliers - 1mm

- 0.30 mm to 0.50 mm (.012" to .020")
- Max. 0.56 mm x 0.71 mm (.022" x .028")



**DE-1379**  
Surgical ball hook crimping pliers,  
angled



**DE-1380**  
Surgical ball hook crimping  
pliers, straight



- Щипцы для ортодонтии и протезирования
- Pincas pour l'orthodontie et la prothèse
- Zangen für Kieferorthopädie und Prothetik
- Щипці для ортодонції та протезування
- Alicates para ortodoncia y prótesis
- كمانشة لتقويم الأسنان برومشتيس

## L-KEY JOINT PLIERS



**DE-1381**  
Aderer Clamp three jaw wire bending plier for contouring and bending wire up to .30"/.76mm.



**DE-1387**  
Falcon beak contouring plier.

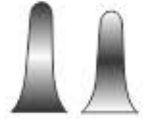

**DE-1382**  
Bird beak plier for bending round, square and rectangle wire up to .30"/.76mm.

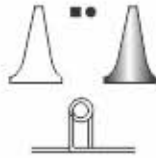

**DE-1388**  
For placement and removal of arch wires, pins and other auxiliaries.



**DE-1383**  
Bird beak plier for light wire bending round, square and rectangular up to .016"/0.41mm.



**DE-1389**  
For placement and removal of arch wires, pins and other auxiliaries in angle design



**DE-1384**  
Double Rounded jaw bending pliers, hooks and wire up to .020"/0.51mm.

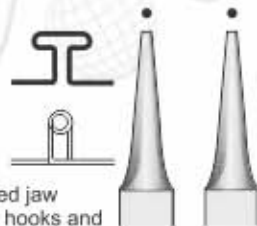

**DE-1390**  
contouring Plier.



**DE-1385**  
Adams pliers for hooks and bending wire up to .030"/0.76mm.



**DE-1391**  
Bending plier. In order to skirt molares bands. With grooved. Recommended wire. 016", 018" and 022" 0.41mm, 0.46mm and 0.56mm



**DE-1392**  
Loop forming in four length 3,4,5 & 6 mm wire capacity 0.22", 56mm.



**DE-1386**  
Johnson pliers for crown band contouring



**DE-1393**  
Arch bending plier design for convenient handling of square or rectangular wire, .020" / 0.51mm.

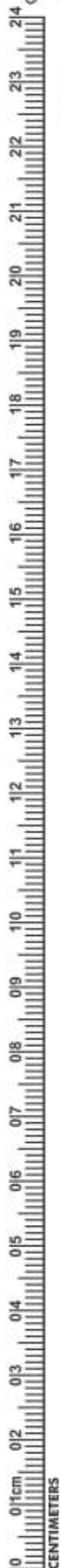

# PLIERS FOR ORTHODONTICS & PROSTHETICS

- Щипцы для ортодонтии и протезирования
- Pincers pour l'orthodontie et la prothèse
- Zangen für Kieferorthopädie und Prothetik
- Щипці для ортодонції та протезування
- Alicates para ortodoncia y prótesis
- كمشة لتقويم الأسنان بروستھتیس

## LAP & L-KEY JOINT PLIERS



**DE-1394**  
In order to skirt bands and crowns.



**DE-1395**  
Wires up to .020" / 0.7mm.

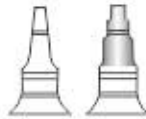

**DE-1396**  
Round and concave plier for loop forming and banding wire up to .20" / .051mm.



**DE-1397**  
Bending for round square or rectangular wire up to 0.30" / 0.76mm



**DE-1398**  
for double back and triple back bands in 0.30" / .76mm & 0.36" / .91mm lingual arch wires.



**DE-1399**  
Detailing step plier double-sided offset beak permits bayonet bends. Creates right hand or left hand step-up or stepdown at 1/2, 3/4, or 1mm increments.



**DE-1400**  
"V" bend stop special design makes 1mm "v" bends to shorten archwires or provide a positive stop. Excellent for placing stops in titanium wires. For round or rectangular wires up to .025"



**DE-1401**  
Angle how plier efficient utility plier with serrated beaks for a firm grip. 45 angled tips to access hard to reach areas.



**DE-1402**  
Weingardt plier serrated tips hold wires firmly at a convenient working angle. Tapered beaks fit easily between brackets and hard to reach areas. Our most popular utility plier.



**DE-1415**  
Pin & Ligature Cutters TC.



**DE-1416**  
Mini Pin & Ligature Cutter TC.



**DE-1417**  
Standard Ligature Cutter TC.



**DE-1418**  
V Bend Stop Plier TC.



**DE-1419**  
Angled Direct Bond Bracket Remover TC.



**DE1-1419**  
Cutter Str.



**Distal Cutter**  
14cm  
**DE2-1419** 2.5 mm  
**DE3-1419** 3.0 mm  
**DE4-1419** 3.0 mm



**DE5-1419**  
Arrow Clasp Forming Pliers  
12.0cm



**DE6-1419**  
Schwarz  
12.5cm



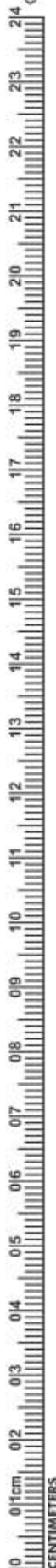

**DE-1420**  
Distal end Cutter, Safety Hold Plier  
(Ideal for Cutting Wire) TC.



**DE-1421**  
Hook Crimping Plier Angled  
Straight TC.



**DE-1422**  
3 Prong Clasp Adjustable  
Plier TC.



**DE-1423**  
Utility Plier Weingart TC.



**DE-1424**  
Direct Bracket Remover  
TC.



**DE-1425**  
Straight Direct Bond Bracket  
Remover TC.



**DE-1426**  
Pin Holding Plier TC.



**DE-1427**  
Hard wire cutters



**DE-1428**  
Elastic Separating Plier  
Round Handle



**DE-1429**  
Elastic  
Separating Plier



**DE-1430**  
**DE-1431**  
Smaha  
Elastomeric  
ligature  
placing forceps  
140 mm



**DE-1432**  
Elastomeric  
ligature placing  
forceps with  
groove  
Falcon 140 mm



**DE-1433**  
Elastomeric  
ligature placing  
forceps with  
groove  
Falcon 140 mm



# Normal Anatomy – Dental Implants

Bone Level Normal  
(No Bone Loss)

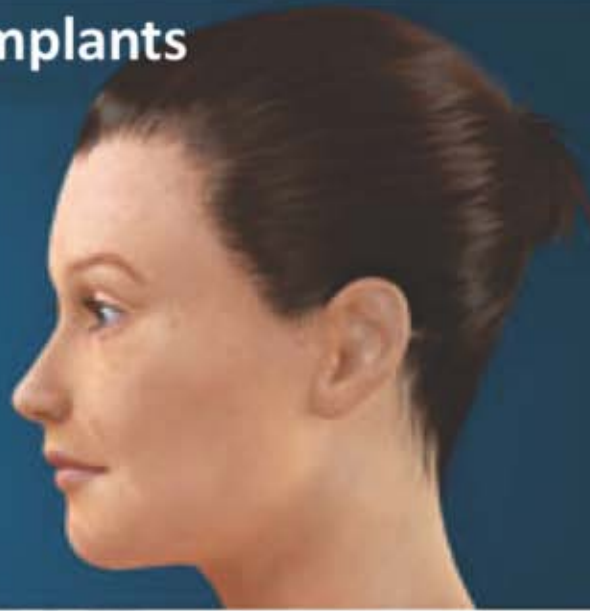
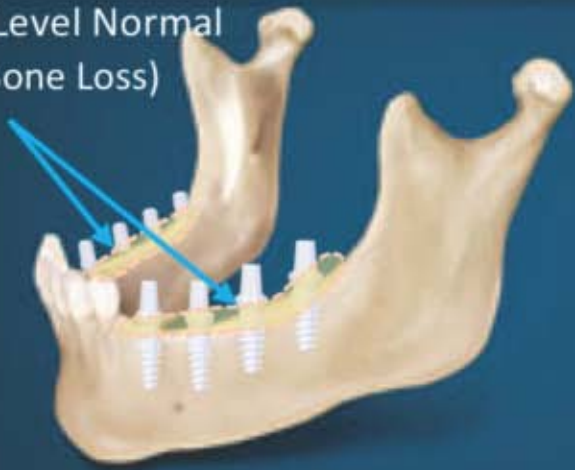

Maxillary sinus

Impacted wisdom teeth

Mandible (lower jaw)

Maxilla (upper jaw)

Nerve (controls feeling in the chin, gum, teeth, and lip)



- Инструменты для имплантологии
- Implantologie
- Implantologie

- Инструменти для імплантології
- Implantologia
- زراعة الأسنان

**IMPLANT GAGES**



**DE-1434**  
**Multifunctional Meter**  
Length 90 mm,  
different sizes,  
8-10-11mm,  
corrosion-resistant

**DE-1435**  
**Multifunctional Meter**  
Length 90 mm,  
different sizes,  
5-13-15-17 mm,  
corrosion-resistant

**DE-1436**  
**Measuring Probe**  
Length 170 mm,  
hand shape or flexible  
(6-8-10-14-16 mm),  
corrosion-resistant

**DE-1437**

**DE-1438**

**DE-1439**

**DE-1440**

**IMPLANT GAGES**



**DE-1441**

**DE-1442**

**DE-1443**



# IMPLANTOLOGY

- Инструменты для имплантологии
- Implantologie
- Implantologie
- Инструменти для імплантології
- Implantoloia
- زراعة الأسنان



**DE-1444**  
Clamp, Osteometer  
Length about 155 mm,  
ridge width measurement,  
two-sided scale,  
measuring  
range 0 - 25 mm



**DE-1445**  
Measuring Loop  
straight length 90 mm,  
measuring range  
0 - 40 mm,



**DE-1446**  
Measuring Loop  
angled, length 90 mm,  
measuring range  
0 - 40 mm,



**DE-1447**  
Measuring loop, Castroviejo  
angled, length 175 mm,  
measuring range 0 - 40 mm,  
with window



**DE-1448**  
Boley Gauge  
Stainless Steel



**DE-1449**  
Measuring Loop  
angled, length  
175 mm,  
measuring range  
0 - 40 mm,



**DE-1450**  
Measuring Loop  
straight length  
175 mm,  
measuring range  
0 - 40 mm,



**DE-1451**  
Fig. 1  
Iwanson  
spring caliper  
For metal and  
porcelain.



**DE-1452**  
Fig. 2  
Iwanson  
spring caliper  
For wax.



**DE-1453**  
Bone Thickness Gauge  
40mm, 180mm



**DE-1454**  
Gauge  
for measuring  
distances  
(0 - 90 mm),



- Инструменты для имплантологии
  - Implantologie
  - Implantologie
- Инструменти для имплантології
  - Implantologia
  - زراعة الأسنان

## BLACK TITANIUM COLOUR COATED INSTRUMENTS

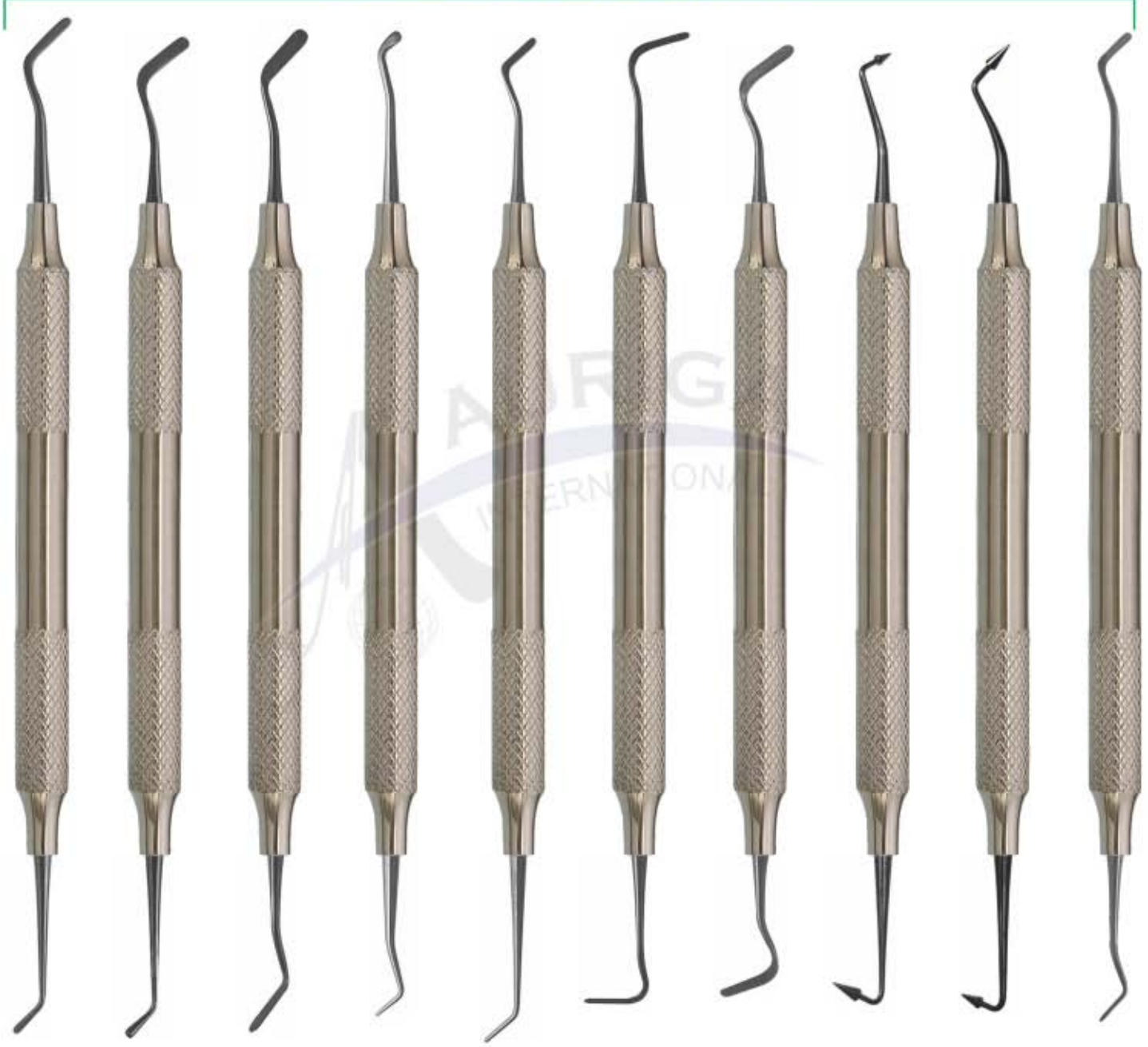

DE-1455 #1	DE-1456 #2	DE-1457 #3 Extra-Flex	DE-1458 Micro-Mini	DE-1459 Mini 1	DE-1460 Mini 4 Extra-Flex	DE-1461 #4 Extra-Flex	DE-1462 #5 Flexi-Thin	DE-1463 #6 Flexi-Thin	DE-1464 Mini 3 Extra-Flex
---------------	---------------	-----------------------------	-----------------------	-------------------	---------------------------------	-----------------------------	-----------------------------	-----------------------------	---------------------------------

# IMPLANTOLOGY

- Инструменты для имплантологии
- Implantologie
- Implantologie
- Инструменти для імплантології
- Implantoloia
- زراعة الأسنان

## BLACK TITANIUM COLOUR COATED INSTRUMENTS

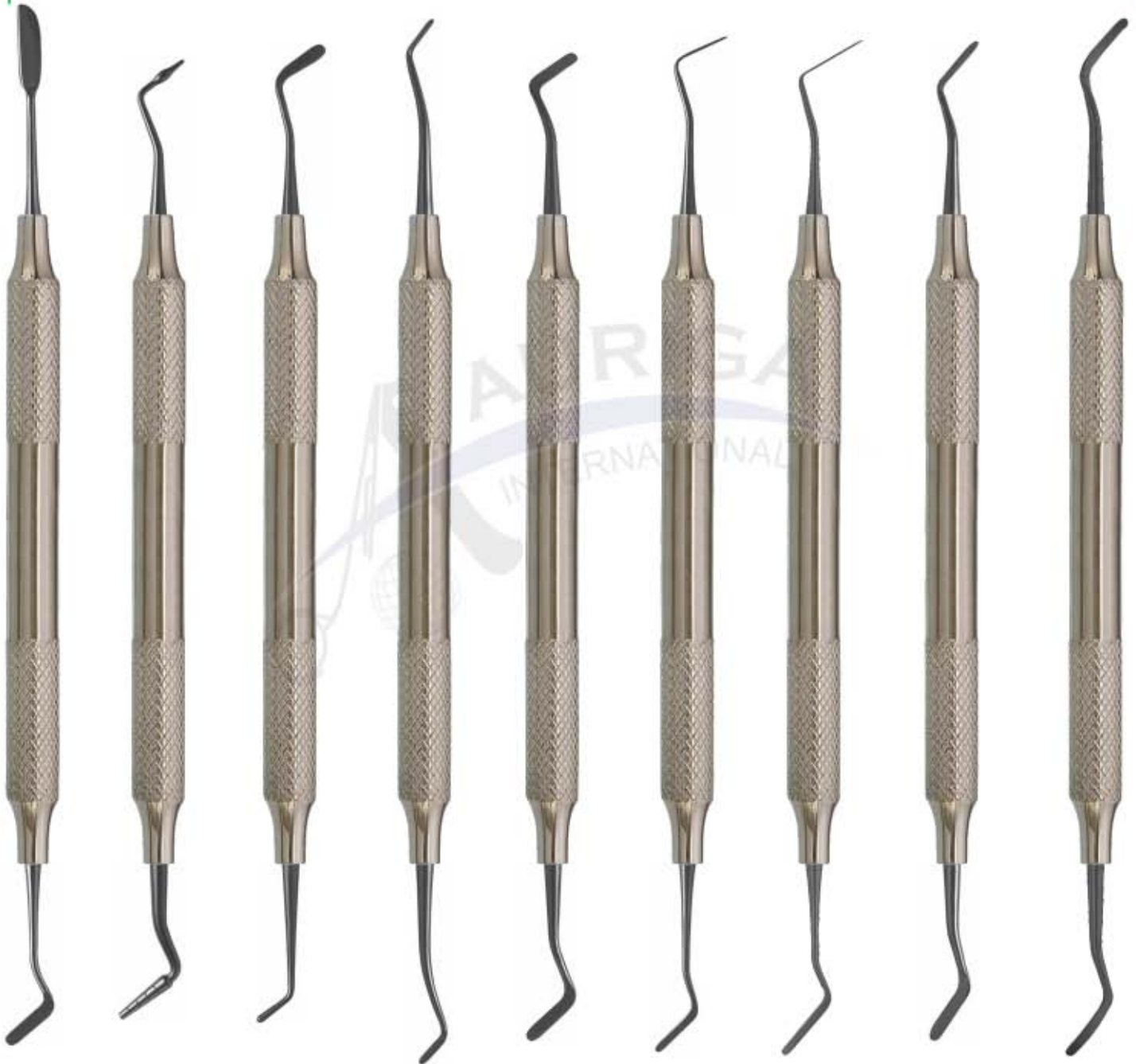

**DE-1465**  
AB1  
Boghosian

**DE-1466**  
AB2  
Boghosian

**DE-1467**  
W3

**DE-1468**  
8A

**DE-1469**  
4/5  
Gregg

**DE-1470**  
Interproximal  
Carver

**DE-1471**  
Interproximal  
Carver, Long

**DE-1472**  
A6

**DE-1473**  
Contouring  
instrument

- Инструменты для имплантологии
  - Implantologie
  - Implantologie
- Инструменти для імплантології
  - Implantoloia
  - زراعة الأسنان

**BLACK TITANIUM COLOUR COATED INSTRUMENTS**

**BURNISHERS**

**FREEDMAN BURNISHERS**

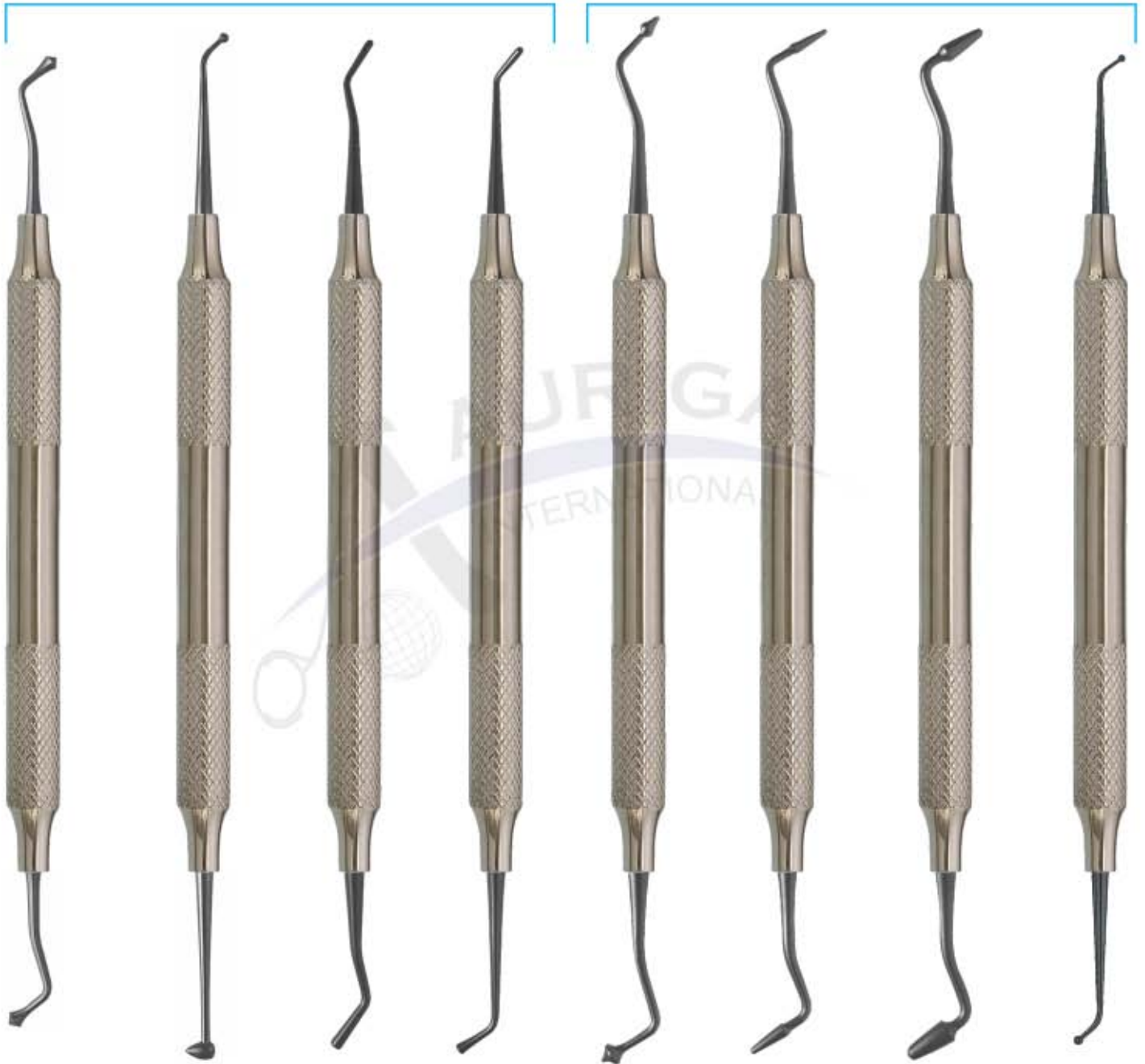

**DE-1474**  
21B

**DE-1475**  
27/29

**DE-1476**  
2  
Ladmore

**DE-1477**  
3  
Ladmore

**DE-1478**  
Freedman  
"Duckhead"

**DE-1479**  
Freedman  
Small Contact  
Forming

**DE-1480**  
Freedman  
Large Contact  
Forming

**DE-1481**  
Small/  
Medium Ball  
Burnisher

10 01cm 02 03 04 05 06 07 08 09 10 11 12 13 14 15 16 17 18 19 20 21 22 23 24  
CENTIMETERS

# IMPLANTOLOGY

- Инструменты для имплантологии
- Instrumentologie
- Implantologie
- Инструменти для имплантології
- Implantoloia
- زراعة الأسنان

## BLACK TITANIUM COLOUR COATED INSTRUMENTS

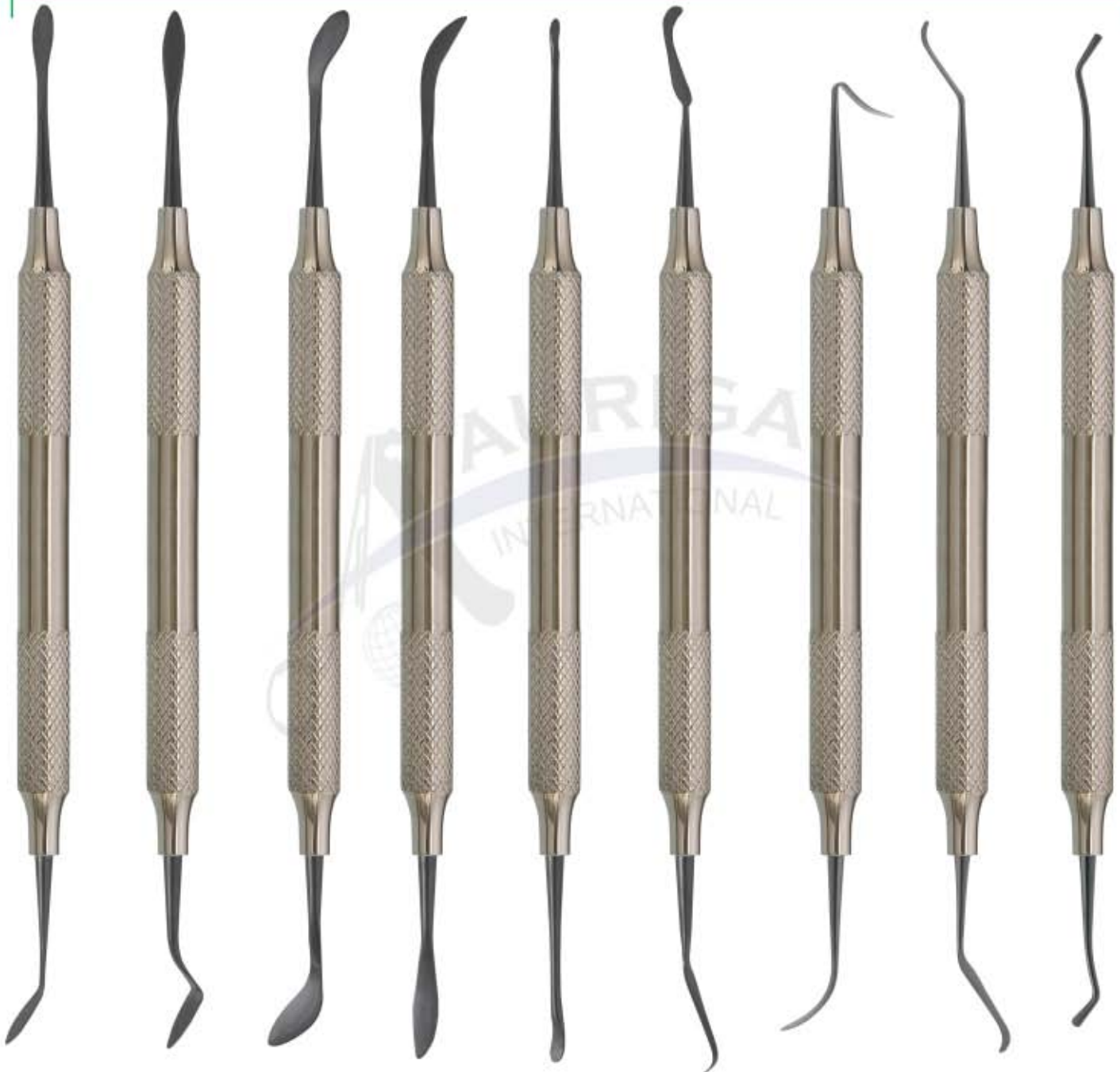

**DE-1482**  
A  
Cosmetic  
Contouring

**DE-1483**  
B  
Cosmetic  
Contouring

**DE-1484**  
C  
Cosmetic  
Contouring

**DE-1485**  
D  
Cosmetic  
Contouring

**DE-1486**  
E  
Cosmetic  
Contouring

**DE-1487**  
F  
Cosmetic  
Contouring

**DE-1488**  
Marginal Ridge  
& Embrasure  
Shaping Instrument

**DE-1489**  
Occlusal  
Anatomy  
Instrument

**DE-1490**  
Composite  
Packing  
Instrument



- Инструменты для имплантологии
- Implantologie
- Implants
- زراعة الأسنان

## BLACK TITANIUM COLOUR COATED INSTRUMENTS

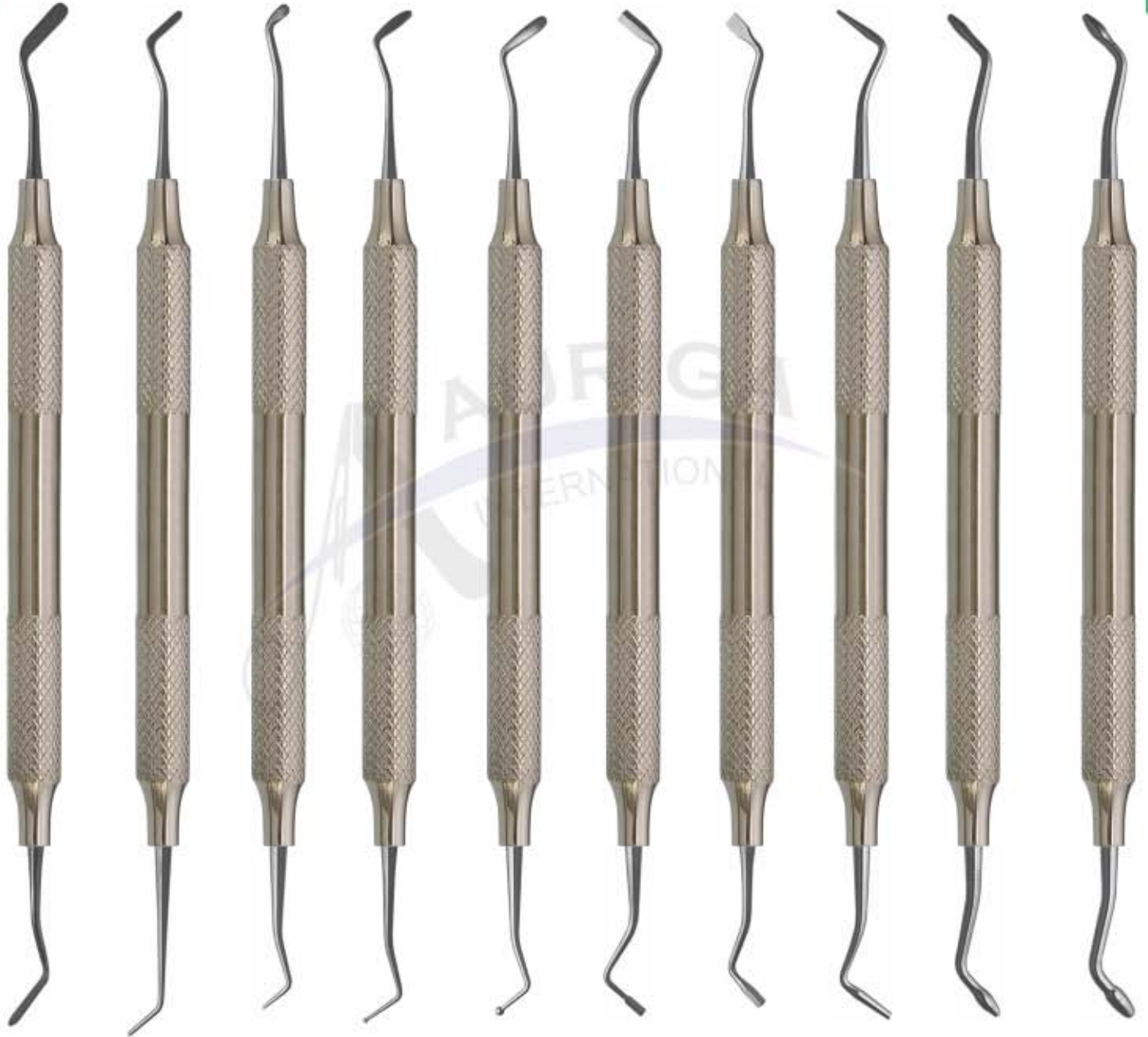

<b>DE-1491</b> #3 Extra-Flex	<b>DE-1492</b> Mini 1	<b>DE-1493</b> Micro-Mini	<b>DE-1494</b> Medium Placing/ Condensing	<b>DE-1495</b> Large Placing/ Condensing	<b>DE-1496</b> OT Tanner	<b>DE-1497</b> 3 Hollenback	<b>DE-1498</b> 5A	<b>DE-1499</b> Small/Medium Contact Forming	<b>DE-1500</b> Medium/Large Contact Forming
------------------------------------	--------------------------	------------------------------	--	---	--------------------------------	-----------------------------------	----------------------	--	--

# IMPLANTOLOGY

- Инструменты для имплантологии
- Instrumentologie
- Implantologie
- Инструменти для имплантології
- Implantoloia
- زراعة الأسنان

## SINUS LIFT INSTRUMENTS HOLLOW HANDLE 9.5MM LENGTH 170MM



**DE-1501**  
Sinus Lift Elevator

**DE-1502**  
Sinus Lift Elevator

**DE-1503**  
Sinus Lift Elevator

**DE-1504**  
Sinus Lift Elevator

**DE-1505**  
Sinus Lift Elevator



- Инструменты для имплантологии
- Instrumentologie
- Implantologie
- Инструменти для имплантології
- Implantologia
- زراعة الأسنان

**SINUS LIFT INSTRUMENTS HOLLOW HANDLE 9.5MM LENGTH 170MM**



**DE-1506**  
Sinus Lift Elevator



**DE-1507**  
Sinus Lift Elevator



**DE-1508**  
Sinus Lift Elevator



**DE-1509**  
Sinus Lift Elevator

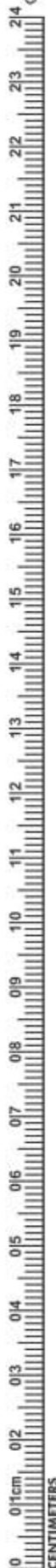

# IMPLANTOLOGY

- Инструменты для имплантологии
- Implantologie
- Implantologie
- Инструменти для імплантології
- Implantoloia
- زراعة الأسنان

## IMPLANT SINUS LIFT INSTRUMENTS HOLLOW HANDLE 9.5MM LENGTH 170MM

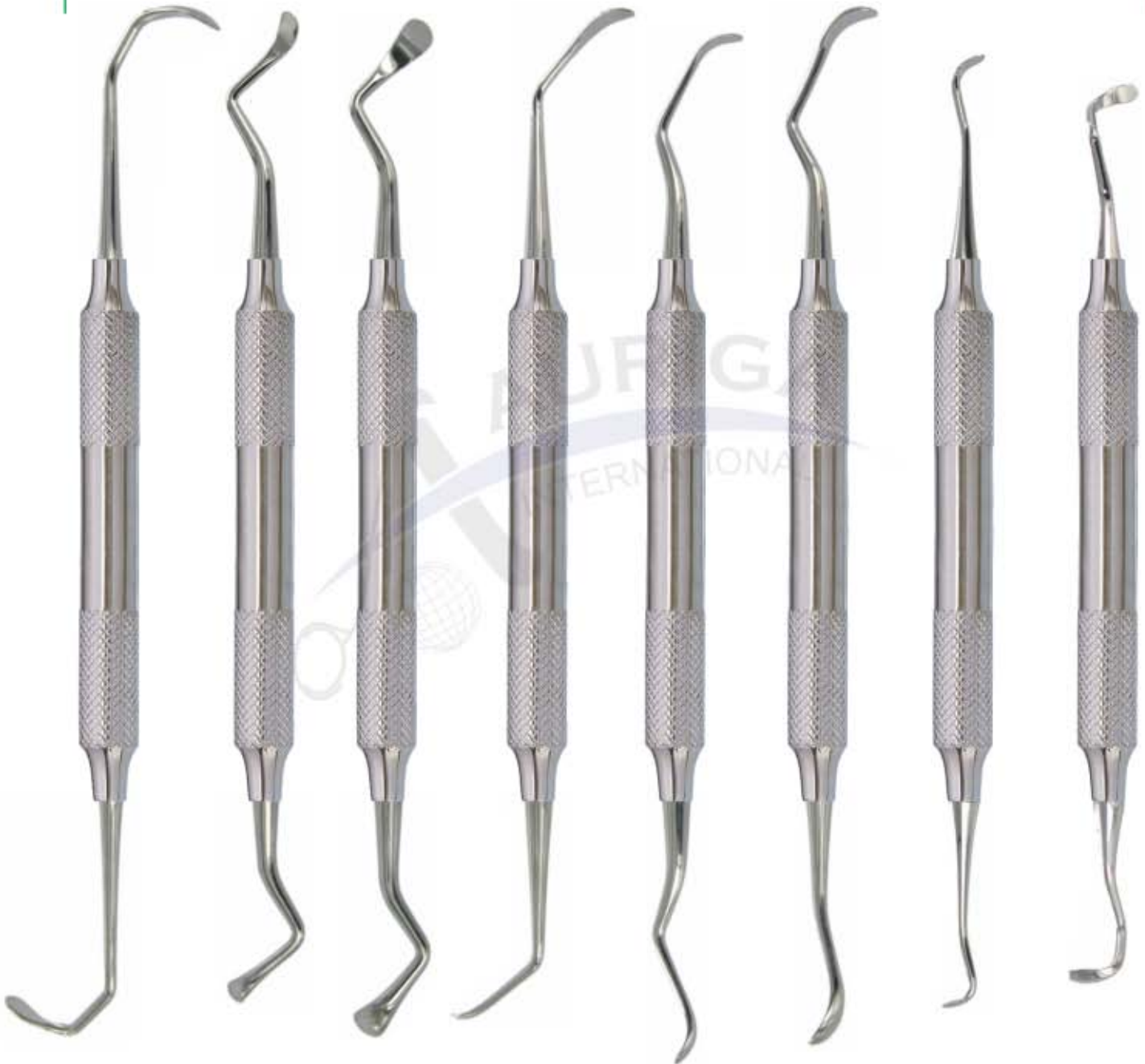

**DE-1510**  
Acute 6577

**DE-1511**  
Sinus1

**DE-1512**  
Sinus2

**DE-1513**  
Sinus3,  
Obtuse 6578

**DE-1514**  
Sinus4

**DE-1515**  
Sinus5

**DE-1516**  
Sinus6

**DE-1517**  
Sinus7

- Инструменты для имплантологии
  - Implantologie
  - Implantologie
- Інструменти для імплантології
  - Implantologia
  - زراعة الأسنان

**SINUS LIFT INSTRUMENTS HOLLOW HANDLE 9.5MM LENGTH 170MM**

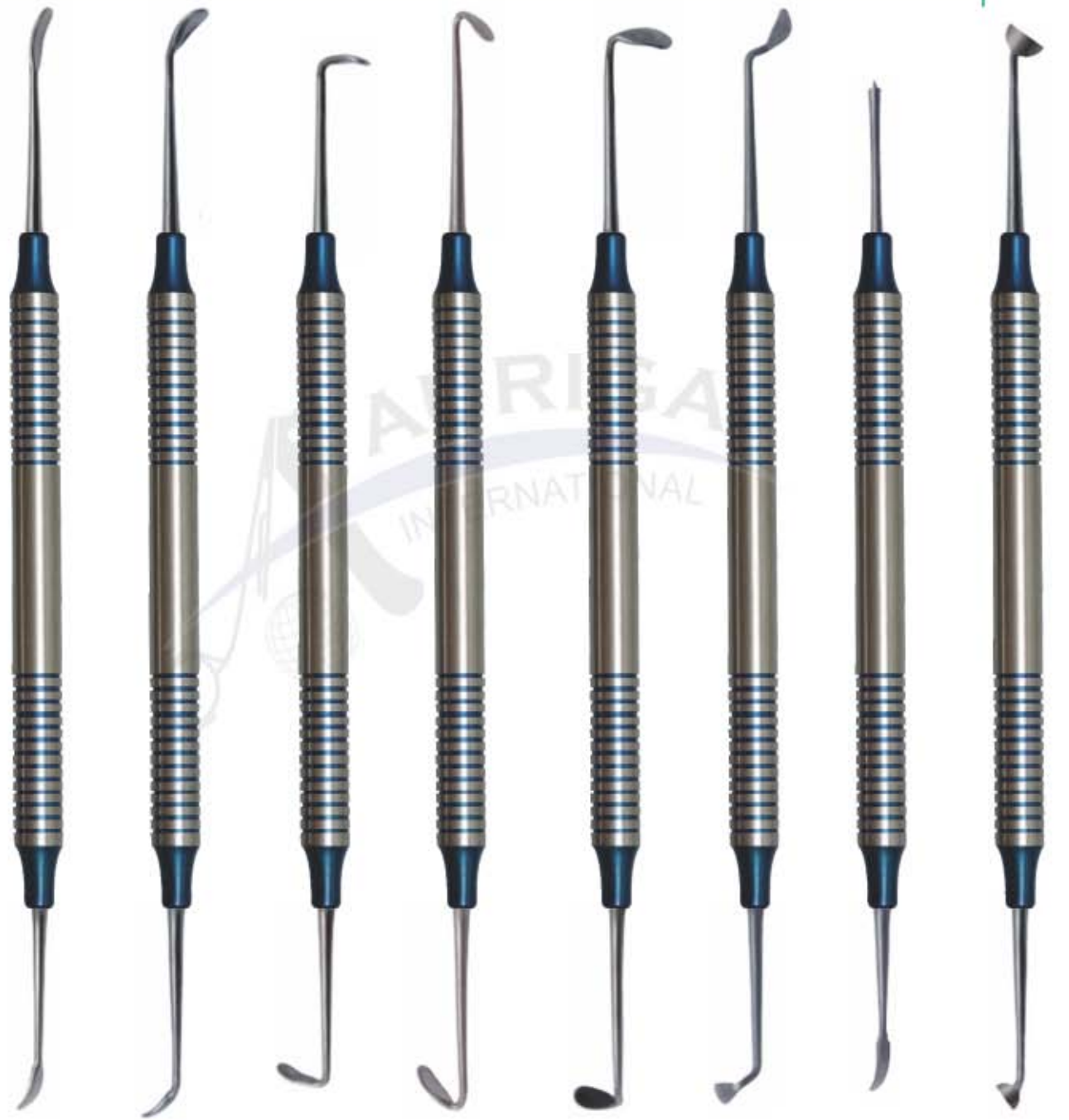

**DE-1518** Sinuslift 1     **DE-1519** Sinuslift 2     **DE-1520** Sinuslift 3     **DE-1521** Sinuslift 4     **DE-1522** Sinuslift 5     **DE-1523** Sinuslift 6     **DE-1524** Membrane 3Positioning 1     **DE-1525** Condenser 1

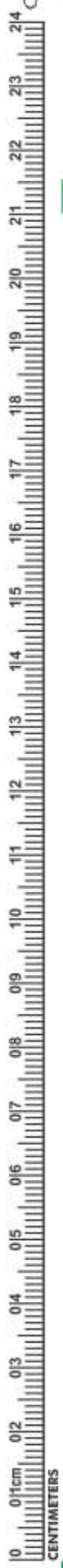

# IMPLANTOLOGY

- Инструменты для имплантологии
- Implantologie
- Implantologie
- Инструменти для имплантології
- Implantologia
- زراعة الأسنان

**Sinus Lift Instrument,**  
Flexible Sinus Lift instruments  
reduce the risk of perforation of the  
"Schneider's membrane"

**Sinus Lift Elevator,**  
10 mm Straight grip  
Length 175 mm, Sinus lift elevators, dull,  
for gentle peeling and lifting the  
Schneider membrane

**Sinus lift instrument**  
10 mm Straight grip Length 180 mm,  
Buser (B1, B2, B3) raspatories,  
quality medical stainless steel,  
corrosion-resistant



DE-1526 Fig. 1    DE-1527 Fig. 2    DE-1528 Fig. 3



DE-1529 Fig. 1    DE-1530 Fig. 2    DE-1531 Fig. 3



DE-1532 B01    DE-1533 B02    DE-1534 B03



- Инструменты для имплантологии
  - Implantologie
  - Implantologie
- Инструменти для імплантології
  - Implantologia
  - زراعة الأسنان

**Sinus lift instrument 10 mm Straight grip Sinus lift elevators, blunt or sharply curved**  
(H01, H02, K03, K04, K78, K77)

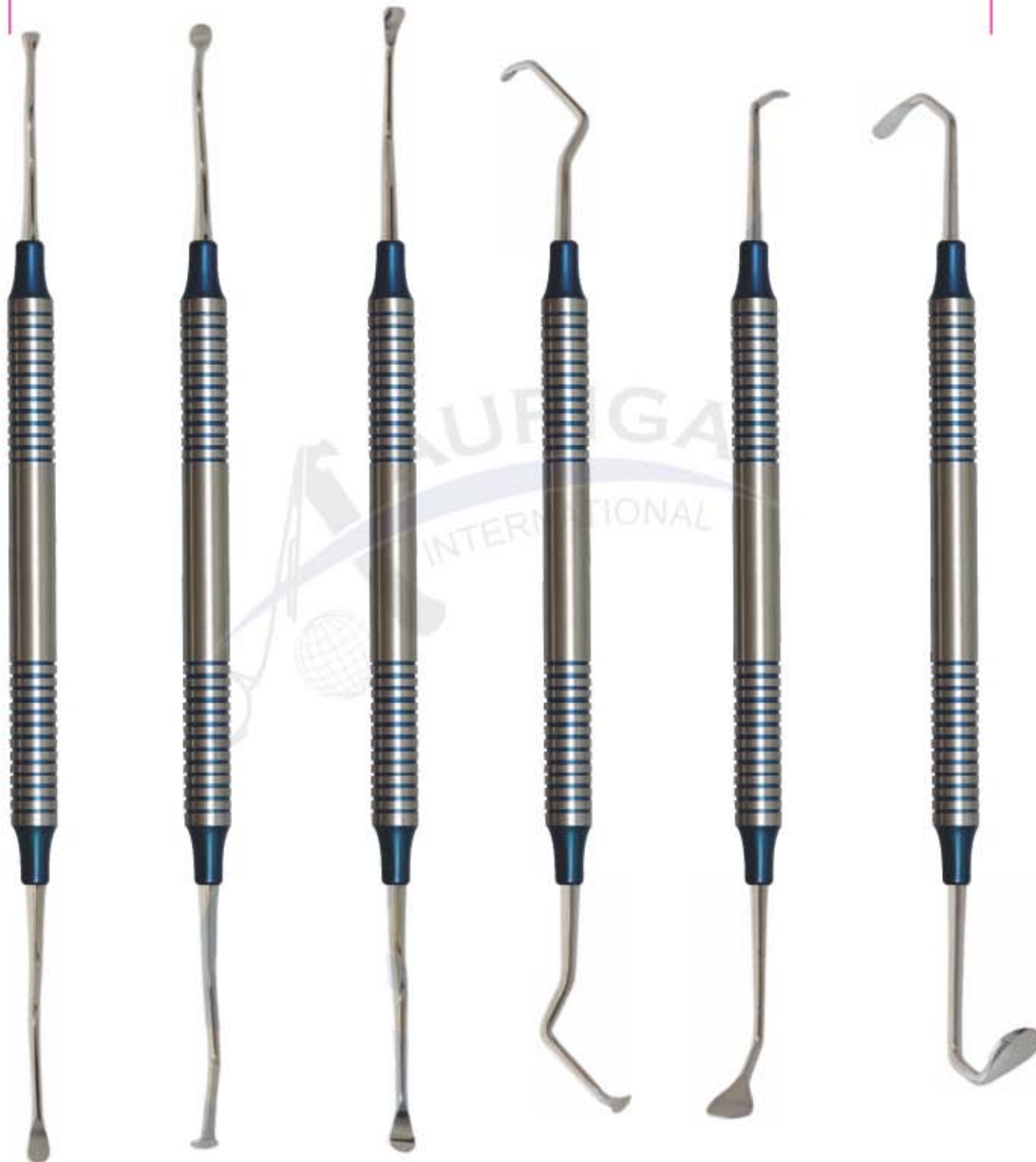

**DE-1535**  
Sinus lift instrument  
H01

**DE-1536**  
Sinus lift instrument  
H02

**DE-1537**  
Sinus lift instrument  
K03

**DE-1538**  
Sinus lift instrument  
K04

**DE-1539**  
Sinus lift instrument  
K78

**DE-1540**  
Sinus lift instrument  
K77

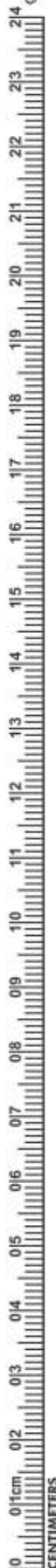

# IMPLANTOLOGY

- Инструменты для имплантологии
- Instrumente für Implantologie
- Implantschirurgie
- زراعة الأسنان

## SINUS LIFT INSTRUMENT

Sinus Lift Elevators, 10 mm Hollow Handle length 170mm Blunt Curved Set of 6 Pcs



- Инструменты для имплантологии
- Implantologie
- Implantologie

- Инструменти для імплантології
- Implantoloia
- زراعة الأسنان

IMPLANT SINUS LIFT INSTRUMENTS  
PERIODONTAL SURGERY SURGICAL CHISELS  
KRAMER NEVINS SINUS LIFT



DE-1547 TG



DE-1548 SOLT3/4



DE-1549 TGO



DE-1550 29K



DE-1551 FEDI4



DE-1552 OCH3



DE-1553 OCH4



DE-1554 FEDI1



DE-1555 FEDI2



DE-1556 FEDI3



DE-1557 GF36

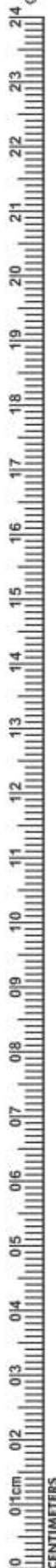

CENTIMETERS

# IMPLANTOLOGY

- Инструменты для имплантологии
- Implantologie
- Implantologie
- Інструменти для імплантології
- Implantoloia
- زراعة الأسنان

## PERIOSTEALS ELEVATOR 10mm Hollow Handle



**DE-1614**  
Raspatory Micro Molt  
Length 175 mm,  
corrosion-resistant

**DE-1615**  
Raspatory Chipping  
Workers:  
Chisel 24G and 7.5 mm,  
length about 175 mm,  
corrosion-resistant

**DE-1616**  
Raspatory MOLT  
Work ends:  
5.0 mm and 4.0 mm,  
length about 175 mm,  
corrosion-resistant

**DE-1617**  
Rasp, Molt M9  
Length 175 mm,  
corrosion-resistant

**DE-1618**  
Raspator, WAUTIER  
Length 175 mm,  
corrosion-resistant

**DE-1619**  
Raspator, BENQUE  
Length 170 mm,  
workers  
5 mm | 7 mm,  
corrosion-resistant

**DE-1620**  
Raspator, Nordberg  
Length 180 mm,  
8 mm hollow handle,  
double-ended  
6 mm | 4 mm

- Инструменты для имплантологии
- Implantologie
- Implantologie

- Інструменти для імплантології
- Implantologia
- زراعة الأسنان

Hollow Handle 10mm Length 170mm

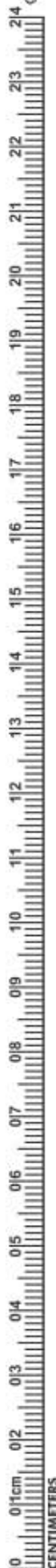

# IMPLANTOLOGY

- Инструменты для имплантологии
- Implantologie
- Implantologie
- Инструменти для имплантології
- Implantoloia
- زراعة الأسنان

## TISSUE MEMBRANE FORCEPS



**DE-1630**  
Tissue Graft Forcep  
Serrated Teeth



**DE-1631**  
Self Locking  
Grooved



**DE-1632**  
Tissue Graft Forcep  
Serrated Teeth



**DE-1633**  
Titanium  
Locking Plier



**DE-1634**  
TC Gripper Carbide  
Tipped Tissue Forceps  
Serrated Carbide Tips  
14.5cm



**DE-1635**  
Adson Carbide  
Tipped Tissue Forceps  
Serrated Carbide Tips  
12cm



**DE-1636**  
Micor Adson 1x2  
Tissue Forcep 12.1cm  
1x2 Teeth - 0.5mm Tips



**DE-1637**  
Adson 7x7  
Tissue Forceps  
7x7 Teeth 12cm



**DE-1638**  
Adson 7x7 Curved  
Tissue Forceps  
7x7 Teeth 12cm



**DE-1639**  
Suture Pliers  
Suture Forceps with  
1.6mm Ring Tip



**DE-1640**  
Debakey Atraumatic  
Tissue Forceps Straight  
Serrated Teeth  
16cm



**DE-1641**  
Debakey Atraumatic  
Tissue Forceps Curved  
Serrated Teeth  
16cm



- Инструменты для имплантологии
- Implantologie
- Implantologie

- Инструменти для імплантології
- Implantologia
- زراعة الأسنان

**TISSUE MEMBRANE FORCEPS**



**DE-1642**  
Russian Long  
Tissue Forceps  
Serrated Tip  
20cm



**DE-1643**  
Russian  
Tissue Forceps  
Serrated Tip  
15cm



**DE-1644**  
Tissue Punch Forceps  
To Remove Tissue  
After Using Punch



**DE-1645**  
13.5 cm  
narrow  
**Membrane tweezers KUEHNE**



**DE-1646**  
10.5 cm  
**Membrane tweezers KUEHNE**



**DE-1647**  
13.5 cm  
wide  
**Membrane tweezers KUEHNE**



**DE-1648**  
Pin-Tweezers  
with or without lock,  
length 15 cm,  
with lock



**DE-1649**  
without lock,



**DE-1650**  
Haltepinzette with lock  
15,5 cm, for pins, towards  
the tips, etc.,



**DE-1651**  
Carry Forceps  
15cm



**DE-1652**  
Carry Forceps  
15cm



**DE-1653**  
Carry Forceps  
15cm

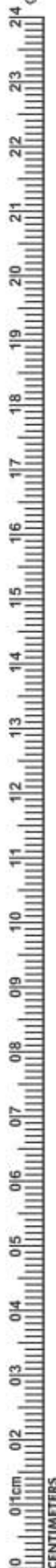

# IMPLANTOLOGY

- Инструменты для имплантологии
- Implantologie
- Implantologie
- Инструменти для імплантології
- Implantologia
- زراعة الأسنان

## OSTEOTOME CONVEXES / CONCAVE / CONIQUES

CONVEXES



**DE-1654**  
SET OF 5 PIECES

CONCAVES



**DE-1655**  
SET OF 5 PIECES

CONIQUES



**DE-1656**  
SET OF 5 PIECES

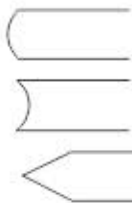
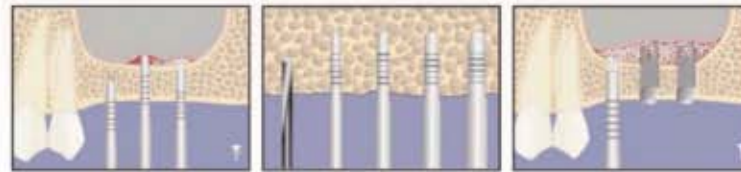

CONVEXES STRAIGHT	DE-1654	2,7 Ømm	3,2 Ømm	3,7 Ømm	4,2 Ømm	5 Ømm
CONCAVES STRAIGHT	DE-1655	2,7 Ømm	3,2 Ømm	3,7 Ømm	4,2 Ømm	5 Ømm
CONIQUES STRAIGHT	DE-1656	2,7 Ømm	3,2 Ømm	3,7 Ømm	4,2 Ømm	5 Ømm



- Инструменты для имплантологии
- Implantologie
- Implantsologie
- Instruments for implantology
- Implantologia
- زراعة الأسنان

**OSTEOTOME CONVEXES / CONCAVE / CONIQUES**

CONVEXES



**DE-1657**  
**SET OF 5 PIECES**

CONCAVES



**DE-1658**  
**SET OF 5 PIECES**

CONIQUES



**DE-1659**  
**SET OF 5 PIECES**

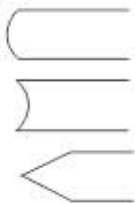
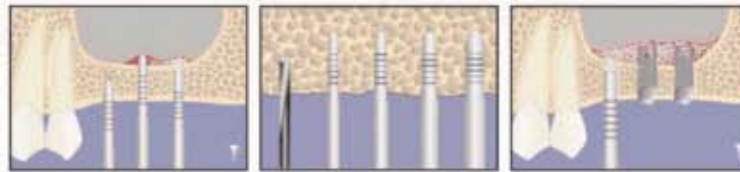

CONVEXES CURVED	<b>DE-1657</b>	2,7 Ømm	3,2 Ømm	3,7 Ømm	4,2 Ømm	5 Ømm
CONCAVES CURVED	<b>DE-1658</b>	2,7 Ømm	3,2 Ømm	3,7 Ømm	4,2 Ømm	5 Ømm
CONIQUES CURVED	<b>DE-1659</b>	2,7 Ømm	3,2 Ømm	3,7 Ømm	4,2 Ømm	5 Ømm



# IMPLANTOLOGY

- Инструменты для имплантологии
- Implantologie
- Implantologie
- Инструменти для имплантології
- Implantologia
- زراعة الأسنان

## TREPHINE

Burs with depth markings are suited for precise and simple transplantation of cylindrical bone grafts as well as for all other bone-extraction tasks.



<b>DE-1660</b> Ø Int. 2 mm Ø Ext. 3 mm	<b>DE-1661</b> Ø Int. 3 mm Ø Ext. 3.5 mm	<b>DE-1662</b> Ø Int. 4 mm Ø Ext. 5 mm	<b>DE-1663</b> Ø Int. 5 mm Ø Ext. 6 mm	<b>DE-1664</b> Ø Int. 6 mm Ø Ext. 7 mm	<b>DE-1665</b> Ø Int. 7 mm Ø Ext. 8 mm	<b>DE-1666</b> Ø Int. 8 mm Ø Ext. 9 mm	<b>DE-1667</b> Ø Int. 9 mm Ø Ext. 10 mm	<b>DE-1668</b> Ø Int. 10 mm Ø Ext. 11 mm
--	--	--	--	--	--	--	---	--

Ø4.0   Ø5.0   Ø6.0   Ø7.0



**DE-1669**  
Tissue Punch with pin  
Set of Four Pieces



**DE-1670**  
Tissue Punch  
Set of Five Pieces



**DE-1671**  
Tissue Punch  
Set of Five Pieces



**DE-1672**  
Trephine Drill  
Set of Eight Pieces



Ø2.0mm   Ø2.5mm   Ø2.8mm   Ø3.2mm   Ø3.65mm   Ø4.2mm   Ø5.2mm

**DE-1673**  
Short Implant Drills

**DE-1674**  
Long Implant Drills



**DE-1675**  
Trephine Drill  
Set of Eight Pieces



- Инструменты для имплантологии
- Implantologie
- Implants
- زراعة الأسنان

### BONE SCRAPER STRAIGHT & CURVED



**DE-1676**  
Bone Scraper  
Straight

**DE-1677**  
Bone Scraper  
Curved

### TISSUE PUNCH STRAIGHT & CURVED



**DE-1678**  
Tissue Punch  
Straight

**DE-1685**  
Tissue Punch  
Curved



**DE-1692**  
Bone Mill



**DE-1693**  
Basins For Bone



**BONE CRUSHER**  
**DE-1694**



# IMPLANTOLOGY

- Инструменты для имплантологии
- Implantologie
- Implantologie
- Инструменти для імплантології
- Implantoloia
- زراعة الأسنان

## KEYS FOR IMPLANT SCREW



DE-1695



DE-1696



DE-1697



DE-1698

## TORQUE WRENCH & RATCHET



DE-1699 Star Torque Wrench 6.35mm Universal



DE-1700 Round Torque Wrench 4.0mm Universal



DE-1701 Hex Driver With 4.0mm Driver



DE-1702 Star Torque Wrench 6.35mm Universal



DE-1703 Hex Torque Wrench 4.00mm Universal



DE-1704 Star Torque Wrench 6.35mm Universal



DE-1705 Star Torque Wrench 6.35mm Universal



DE-1706 Star Torque Wrench 6.35mm Universal



DE-1707 Star Torque Wrench 6.35mm Universal



DE-1708 Star Torque Wrench 6.35mm Universal



DE-1709 Star Ratchet Wrench 6.35mm Universal



DE-1710 Star Ratchet Wrench 6.35mm Universal



DE-1711 Star Ratchet Wrench 6.35mm Universal



DE-1712 Star Ratchet Wrench 4.0mm Universal



DE-1713 Round Ratchet Wrench 4.0mm Universal



DE-1714 Round Ratchet Wrench 3.35mm Universal



DE-1715 Star Ratchet Wrench 4.0mm Universal



DE-1716 Star Ratchet Wrench 6.35mm Universal



- Инструменты для имплантологии
- Implantologie
- Implantologie

- Инструменти для імплантології
- Implantoloia
- زراعة الأسنان



**DE-1717**  
**BONE CRUSHER**  
Titanium Metal Cutter

mallet



**DE-1718**  
**BONE CRUSHER**  
Titanium Metal Cutter

mallet



**DE-1719**  
**BONE CRUSHER**



**DE-1720**  
**BONE CRUSHER**  
Bone Grinding Grain  
1.5mm, 2mm, 2.5mm



**DE-1721**  
**BONE CRUSHER**  
Bone Grinding Grain  
1.5mm, 2mm, 2.5mm

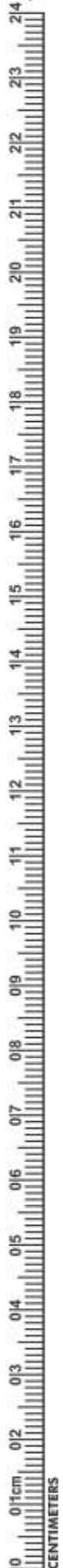

CENTIMETERS

# IMPLANTOLOGY

- Инструменты для имплантологии
- Implantologie
- Implantologie
- Инструменти для імплантології
- Implantoloia
- زراعة الأسنان

## BONE EXPANDER SCREW & SURGICAL KITS



**DE-1722**  
 Bone Universal Kit  
 Drill: 2mm, 2.8mm, 3.2mm, 3.65mm,  
 4.2mm, 4.5mm, 4.8mm, 5.2mm  
 Trephines Bit:  
 3.0mm, 4.0mm, 5.0mm, 6.0mm,  
 7.0mm, 8.0mm, 9.0mm, 10mm.  
 Driver:  
 2.5mm, 2.5mm Hand Pcs  
 1.25mm, 1.25mm Hand Pcs  
 Short Driver 2.5mm  
 Long Driver 2.5mm  
 1.25mm, Short Hex Driver Hand Pcs  
 1.25mm, Long Hex Driver Hand Pcs  
 Torque Wrench 4.0mm



**DE-1723**  
 Bone Expander Kit  
 Expander: 2.6mm, 3.0mm,  
 3.4mm, 3.8mm, 4.3mm  
 Ratchet Driver  
 Parallel Pin  
 Pilot Drill  
 Drill 1.4mm  
 Drill Driver 4mm  
 Hand Driver 4mm  
 Ratchet 4.0mm



**DE-1724**  
 Bone Universal Kit  
 Drill: 2mm, 2.8mm, 3.2mm, 3.65mm,  
 4.2mm, 4.5mm, 4.8mm, 5.2mm  
 Trephines Bit:  
 3.0mm, 4.0mm, 5.0mm, 6.0mm,  
 7.0mm, 8.0mm, 9.0mm, 10mm.

Bone Compression:  
 2mm, 3.3mm, 2.8mm, 4.2mm, 3mm, 3.5mm  
 Driver:  
 2.5mm, 2.5mm Hand Pcs  
 1.25mm, 1.25mm Hand Pcs  
 Short Driver 2.5mm  
 Long Driver 2.5mm  
 1.25mm, Short Hex Driver Hand Pcs  
 1.25mm, Long Hex Driver Hand Pcs  
 Torque Wrench 6.35mm 1 Pcs



**DE-1725**  
 Corical Drills: 20 Pcs  
 Tissue Punches:  
 3.0mm, 3.50mm, 4.0mm, 4.5mm,  
 5.0mm, 6.0mm, 6.50mm  
 Bone Expander:  
 1.6/3.8mm, 1.9/3.0mm, 2.1/3.6mm,  
 2.6/3.8mm, 2.9/4.3mm  
 Drill Adapter: 1 Pcs  
 1.25mm, 2.50mm Hex Driver Hand Pcs

Pilot Drill: 1.6mm  
 Drill Bit: 1.4mm, 1.6mm, 1.8mm, 2.0mm, 2.2mm  
 Ratchet Driver: 4mm/6.35, 1.25/2.50  
 Rimer: 3.2/4.7mm, 3.7/4.7mm  
 Parallel Pin: 4.5mm, 2.5mm  
 Double step Drill: 2.4/2.8mm  
 Depth Gauge: 1 Pcs  
 Torque Wrench 6.35mm Universal: 1 Pcs



- Инструменты для имплантологии
- Implantologie
- Implantsologie
- Instruments for implantology
- Implantsologie
- زراعة الأسنان

## BONE INJECTORS, COLLECTORS & SUCTION TUBE



**DE-1726**  
Ø 2,5mm /  
3,5mm  
170mm

**DE-1727**  
Ø 4,5mm /  
5,5mm  
170mm

**DE-1728**  
Ø 3,5mm /  
4,5mm  
170mm

**DE-1729**  
Ø 6,0mm /  
7,0mm  
170mm



**DE-1730**  
18cm  
Straight / Bend  
I.D 2.5mm  
O.D 3.5

**DE-1731**  
18cm  
Straight / Bend  
I.D 3.5mm  
O.D 4.5

**DE-1732**  
18cm  
Straight / Bend  
I.D 4.5mm  
O.D 5.5

**DE-1733**  
18cm  
Straight / Bend  
I.D 6.0mm  
O.D 7.0



**DE-1734**  
17.5cm

**DE-1735**  
18cm

**DE-1736**  
coarse  
Ø 5mm

Suction tubes  
to collect  
the extracted  
bone material  
180mm

**DE-1737**  
fine  
Ø 9mm



**DE-1738**  
Suction  
Tubes  
180mm

**DE-1739**  
Suction  
Tubes  
180mm

**DE-1740**  
Suction  
Tubes  
180mm



**DE-1741**  
Fig. 6FR  
Frazier  
15 cm - Ø 2 mm

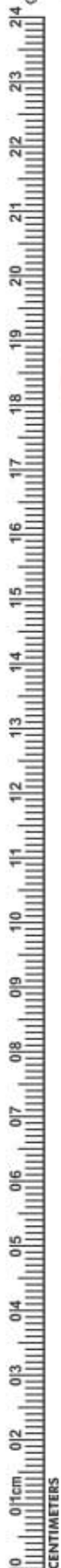

# IMPRESSION TRAYS

- Оттисковые ложки
- Відбиткові ложки
- Porte-empreinte
- Cubetas para impresiones
- Abdrucklöffel
- صوتي الانطباع

## PERFORATED WITH RIM LOCK

Set of 06 Pcs



### DE-1745 SET OF 06 PCS

Upper: S, M, L  
Lower: S, M, L

## PERFORATED WITH RIM LOCK

Set of 8 Pcs



### DE-1746 SET OF 08 PCS

Upper: XS, S, M, L  
Lower: XS, S, M, L

### DE-1747 SET OF 08 PCS

Upper: S, M, L, XL  
Lower: S, M, L, XL

### DE-1748 SET OF 10 PCS

Upper: XS, S, M, L, XL  
Lower: XS, S, M, L, XL



- Оттисные ложки
- Porte-empreinte
- Abdrucklöffel
- Відбиткові ложки
- Cubetas para impresiones
- صواني الانطباع

**SOLID WITH RIM LOCK**  
Set of 6 Pcs

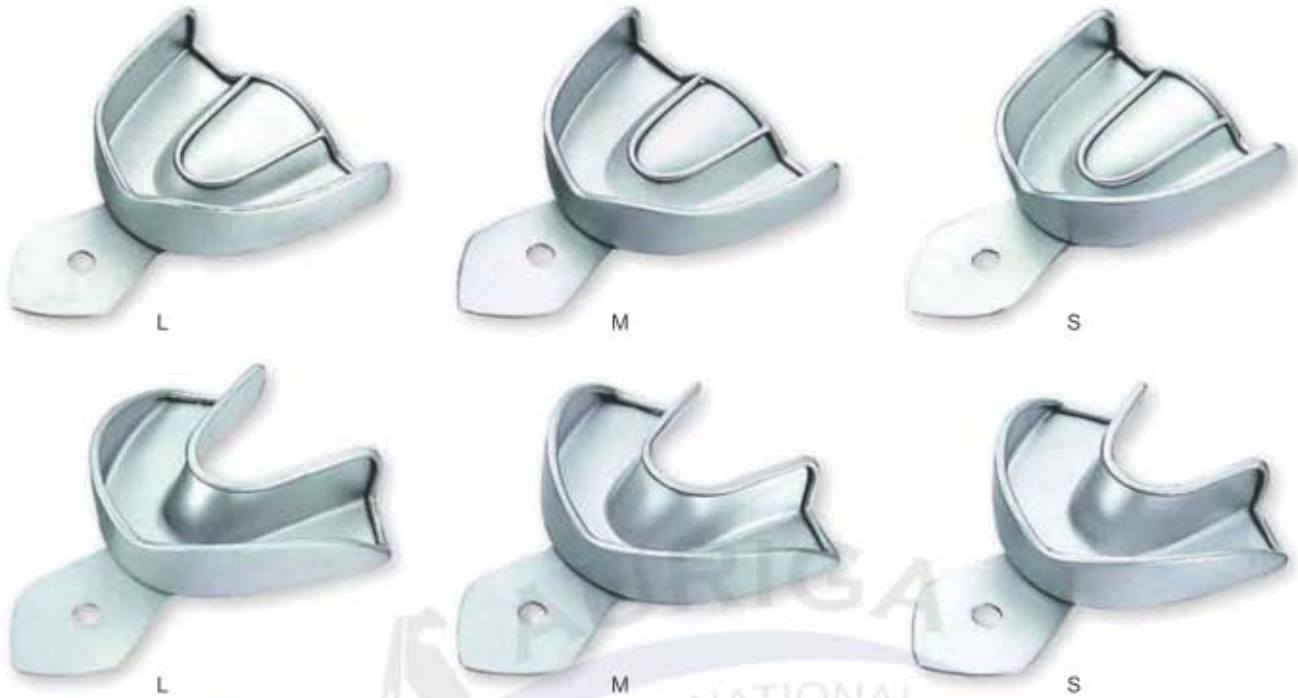

**DE-1749 SET OF 06 PCS**  
Upper: S, M, L  
Lower: S, M, L

**SOLID WITH RIM LOCK**  
Set of 8 Pcs



**DE-1750 SET OF 08 PCS**  
Upper: XS, S, M, L  
Lower: XS, S, M, L

**DE-1751 SET OF 08 PCS**  
Upper: S, M, L, XL  
Lower: S, M, L, XL

**DE-1752 SET OF 10 PCS**  
Upper: XS, S, M, L, XL  
Lower: XS, S, M, L, XL

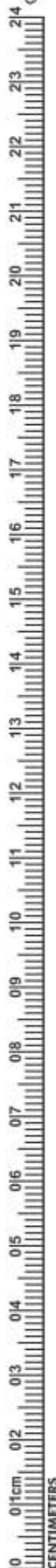

# IMPRESSION TRAYS

- Оттисковые ложки
- Відбиткові ложки
- Porte-empreinte
- Cubetas para impresiones
- Abdrucklöffel
- صوتي الانطباع

## PERFORATED FULL DENTURE Set of 8 Pcs

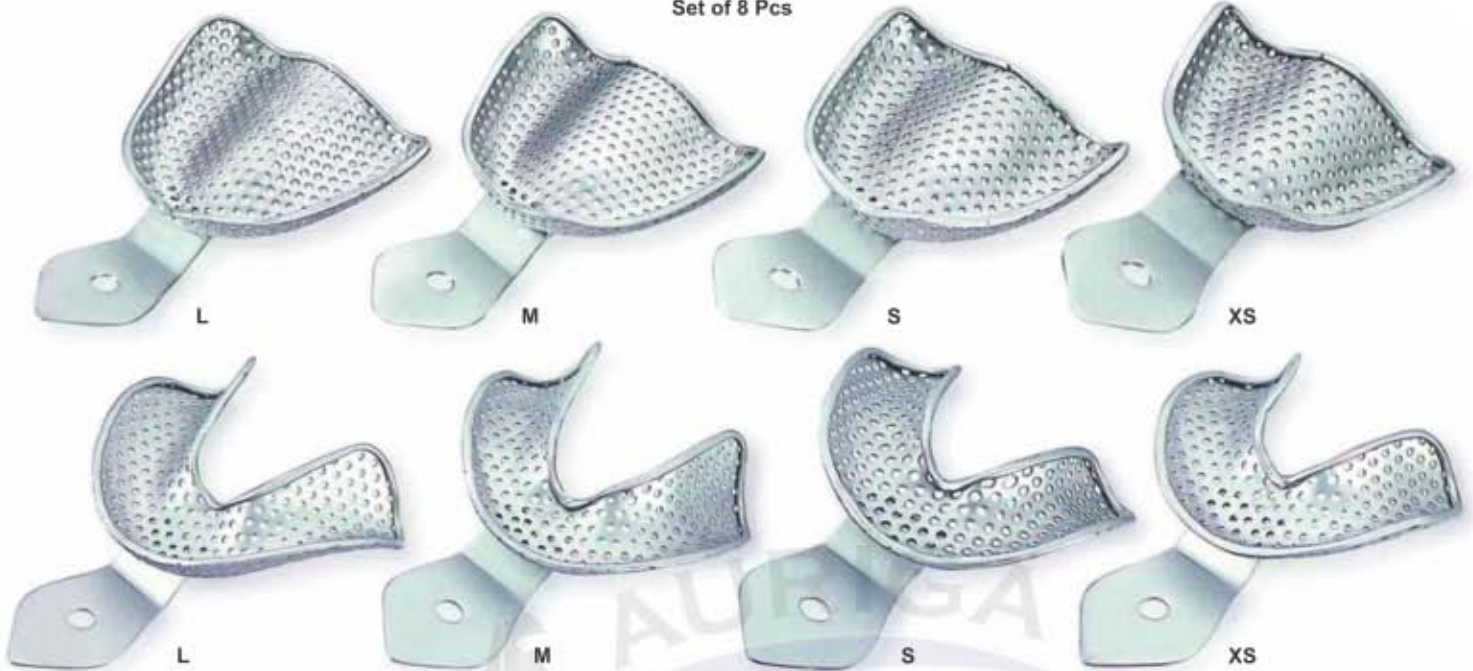

**DE-1753 SET OF 08 PCS**  
Upper: S, M, L, XL  
Lower: S, M, L, XL

**DE-1754 SET OF 08 PCS**  
Upper: S, M, L  
Lower: S, M, L

## SOLID FULL DENTURE Set of 8 Pcs

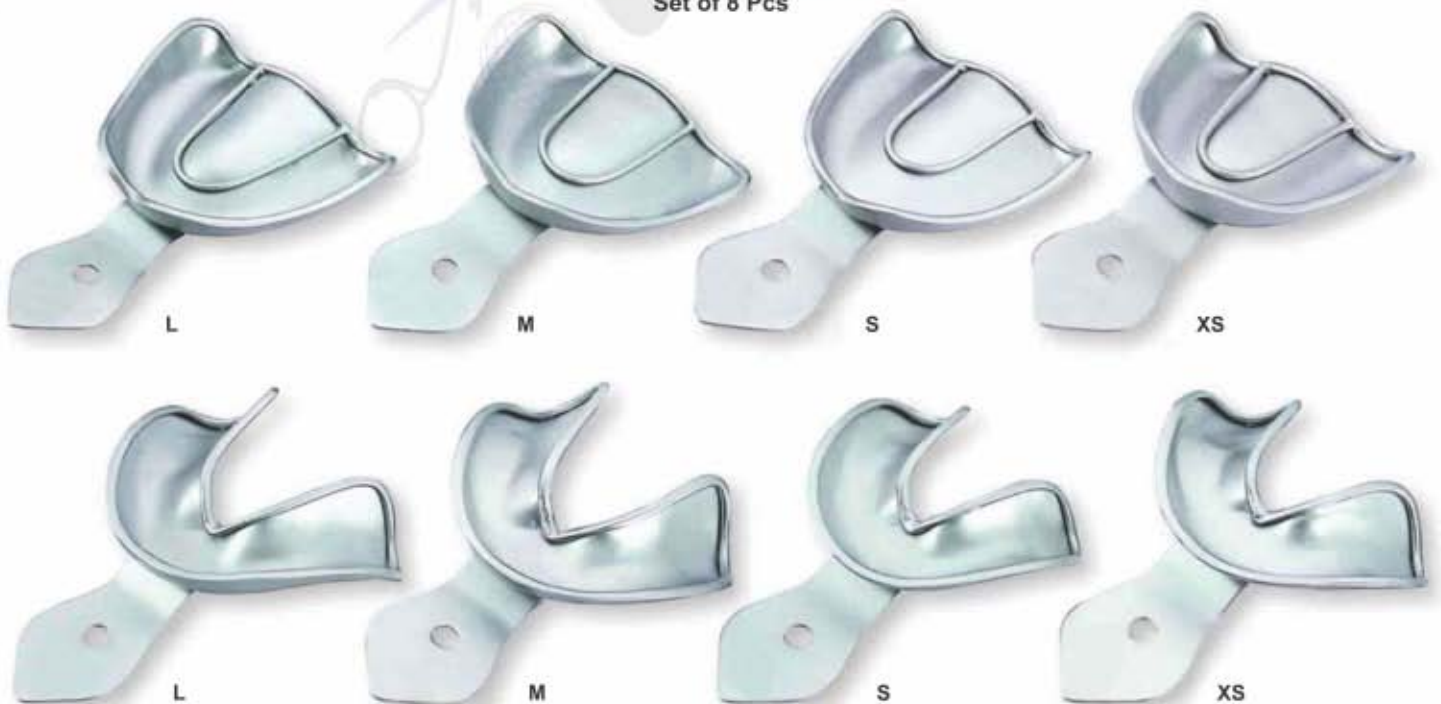

**DE-1755 SET OF 08 PCS**  
Upper: S, M, L, XL  
Lower: S, M, L, XL

**DE-1756 SET OF 06 PCS**  
Upper: S, M, L  
Lower: S, M, L



- Оттисные ложки
  - Porte-empreinte
  - Abdrucklöffel
- Відбиткові ложки
  - Cubetas para impresiones
  - صواني الانطباع

**Perforated Without Rim Lock**



**Solid With Rim Lock**

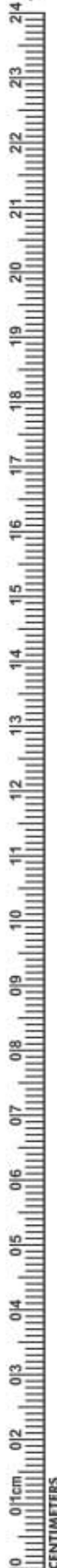
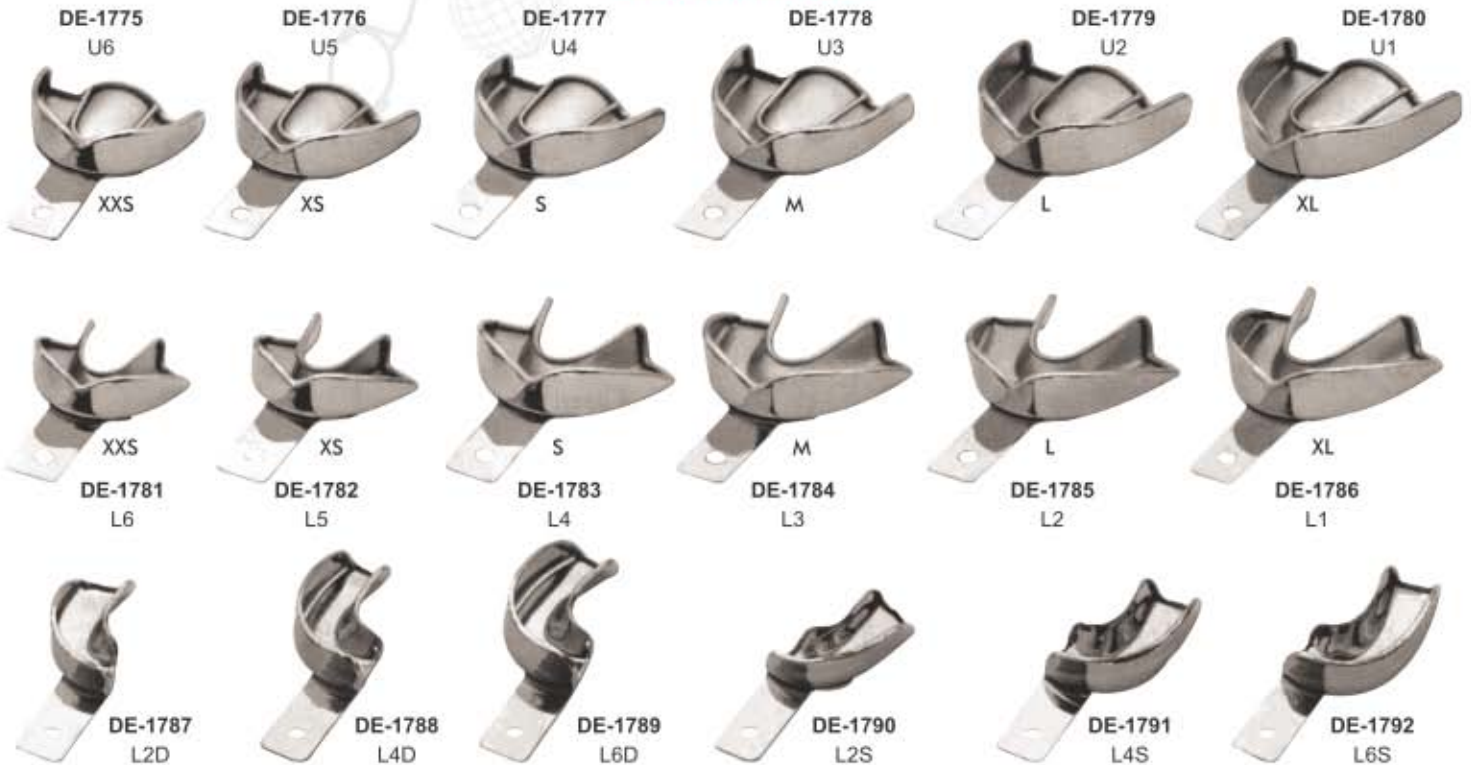

# INSTRUMENTS CASSETTES & STANDS



**DE-1793**  
Mesh Cassettes  
5 Pieces, 7 Pieces, 10 Pieces,  
15 Pieces & 20 Pieces

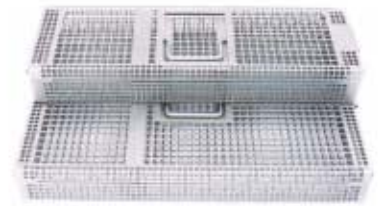

**DE-1795**  
Instruments Cassette  
7 Pieces & 10 Pieces



**DE-1796**  
Gracey Curette Set Cassettes



**DE-1797**  
182 x 150 x 20 mm  
10 Instruments



**DE-1798**  
180 x 85 x 15 mm  
5 Instruments



**DE-1799**  
288 x 182 x 35 mm  
20 Instruments



**DE-1800**  
288 x 182 x 35 mm  
20 Instruments



**DE-1801**  
182 x 145 x 35 mm  
10 Instruments



**DE-1802**  
182 x 72 x 35 mm  
5 Instruments



**DE-1803**  
182 x 145 x 35 mm  
9 Instruments



**DE-1804**  
Gracey Curette Set Stand

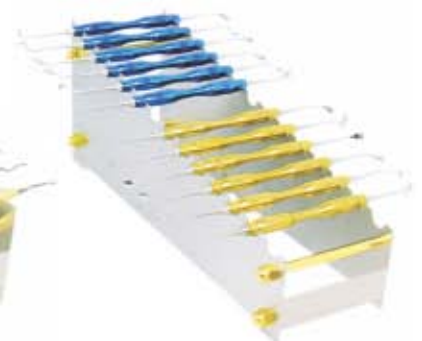

**DE-1805**  
Sinus Lift Set Stand



Made of 18/8 stainless steel



**KIDNEY TRAY WITH COVER**  
(English Pattern)

DE-1806	Size
DE-1807	150 mm
DE-1808	200 mm
DE-1809	240 mm
	300 mm



**Kidney Trays**

With lid available		Without lid available	
DE-1810	6"	DE-1814	6"
DE-1811	8"	DE-1815	8"
DE-1812	10"	DE-1816	10"
DE-1813	12"	DE-1817	12"



Deep	DE-1818	2.25" - 2"
	DE-1819	4.75" - 2"
	DE-1820	5.5" - 2.5"
	DE-1821	6.25" - 2.75"
	DE-1822	7" - 3.5"



**Sterilizing Drum**

Art #	Ø mm	h mm
DE-1823	80	80
DE-1824	120	120
DE-1825	160	120
DE-1826	190	140
DE-1827	190	200
DE-1828	240	120
DE-1829	240	160
DE-1830	240	240
DE-1831	290	120
DE-1832	290	160
DE-1833	290	240
DE-1834	340	160
DE-1835	340	240
DE-1836	390	145
DE-1837	390	200
DE-1838	390	290



**Bowl**  
DE-1839 Fig. 1 to 14



**DE-1840**  
Endodontic Box



DE-1841 6" x 8"  
DE-1842 8" x 10"  
DE-1843 10" x 12"  
Without Lid



**DE-1844**  
Instruments Box



**SCALER TRAY**  
DE-1845  
100 x 200 mm



# HOLLOW WARE

Sterilizing Cases  
Stainless Steel



- DE-1846 130X50X50 mm
- DE-1847 130X60X50 mm
- DE-1848 140X80X50 mm
- DE-1849 150X60X50 mm
- DE-1850 160X30X25 mm
- DE-1851 170X70X30 mm
- DE-1852 180X80X40 mm
- DE-1853 180X90X40 mm
- DE-1854 200X100X40 mm

- DE-1855 220X120X50 mm
- DE-1856 230X130X50 mm
- DE-1857 230X150X50 mm
- DE-1858 250X100X50 mm
- DE-1859 300X150X50 mm
- DE-1860 300X200X50 mm
- DE-1861 350X160X60 mm
- DE-1862 400X200X90 mm
- DE-1863 500X200X125 mm

- DE-1864 130X50X50 mm
- DE-1865 130X60X50 mm
- DE-1866 140X80X50 mm
- DE-1867 150X60X50 mm
- DE-1868 160X30X25 mm
- DE-1869 170X70X30 mm
- DE-1870 180X80X40 mm
- DE-1871 180X90X40 mm
- DE-1872 200X100X40 mm

- DE-1873 220X120X50 mm
- DE-1874 230X130X50 mm
- DE-1875 230X150X50 mm
- DE-1876 250X100X50 mm
- DE-1877 300X150X50 mm
- DE-1878 300X200X50 mm
- DE-1879 350X160X60 mm
- DE-1880 400X200X90 mm
- DE-1881 500X200X125 mm



INSTRUMENTS BOX

- DE-1882 130/50/50 mm
- DE-1883 130/60/50 mm
- DE-1884 140/80/50 mm
- DE-1885 150/60/50 mm
- DE-1886 160/30/25 mm
- DE-1887 170/70/30 mm
- DE-1888 180/80/40 mm
- DE-1889 180/90/40 mm
- DE-1890 200/100/40 mm
- DE-1891 220/120/50 mm

- DE-1892 230/130/50 mm
- DE-1893 230/150/50 mm
- DE-1894 250/150/50 mm
- DE-1895 300/150/50 mm
- DE-1896 300/200/50 mm
- DE-1897 350/160/60 mm
- DE-1898 350/160/60 mm
- DE-1899 400/200/90 mm
- DE-1900 500/200/125 mm



NEEDLES BOX

- DE-1901 150/60/20 mm
- DE-1902 140/80/20 mm
- DE-1903 220/120/20 mm



FORCEPS JAR

- DE-1904 Fig. 1 to 5
- | Ø  | h   |
|----|-----|
| mm | mm  |
| 52 | 100 |
| 52 | 130 |
| 52 | 175 |
| 70 | 130 |
|    | 175 |
|    | 200 |
|    | 200 |



Forceps Jars

- DE-1905 Fig. 3/3
- | Ø  | h   |
|----|-----|
| mm | mm  |
| 25 | 130 |



Forceps Jar

- DE-1906 25 x 80mm
- DE-1907 30 x 100mm
- DE-1908 100 x 200mm
- DE-1909 75 x 173mm





Mm Hmm  
55 70  
**Cotton Holders**  
DE-1910 Fig. 000/1



**Cotton Holder -**  
DE-1911



**DE-1912**  
Sprit Lamp  
Single Nut



**DE-1913**  
Sprit Lamp



**DE-1914**  
Endodontic Box  
Small & Large



**DE-1915**  
Needle Case Round with Cover



**DE-1916**  
Bedpan Perfection Type  
Small & Large



**DE-1917**  
Urinal Female, Urinal Male, Urinal Male Vertical

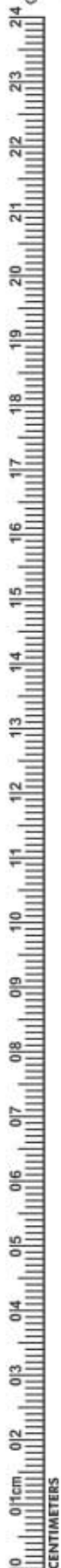

# IMPLANTOLOGY

- Инструменты для имплантологии
- Implantologie
- Implantologie
- Інструменти для імплантології
- Implantoloia
- زراعة الأسنان



**DE-1918**  
Endo Finger Ruler  
Span Measure Scale



**DE-1919**  
Endo Finger Ruler  
Span Measure Scale



**DE-1920**  
Endo Finger Ruler  
Span Measure Scale



**DE-1921**  
Amalgam Gun



**DE-1922**  
Brush Stainless Steel



**DE-1923**  
Suction Cannula Kit  
with 3 Needles



**DE-1924**  
Suction Pipe



**DE-1925**  
Suction Needle  
1mm



**DE-1926**  
Suction Needle  
1.5mm



**DE-1927**  
Suction Needle  
2mm





DESCRIPTION	PAGE #	DESCRIPTION	PAGE #	DESCRIPTION	PAGE #
3 PRONG CLASP ADJUSTABLE PLIER TC	107	BEDPAN PERFECTION TYPE SMALL & LARGE	150	EXPLORERS INSTRUMENTS	35
ACORN FILLING INSTRUMENTS	52	BRUSH STAINLESS STEEL	151	EXPLORERS	33-45
ADAM Plier WITH TC	102	COMPOSITE FILLING INSTRUMENTS	74A	EXTRACTING FORCEPS (AMERICAN PATTERN)	10-14
ADAMS PLIER ROUND BOX	100	COMPOSITE FILLING INSTRUMENTS	74B	EXTRACTING FORCEPS (ENGLISH PATTERN)	01-02, 05-07
ADAMS PLIERS FOR BENDING WIRE	100	COMPOSITE FILLING INSTRUMENTS	74C	EXTRA-FLEX IMPLANTOLOGY INSTRUMENTS	114
ADAMS, SMALL WIRE BENDING AND LOOP FORMING PLIERS	99	COMPASSO DE WILLIS	96	ENDODONTIC BOX SMALL & LARGE	150
ADERER FACEBOW LOOP FORMING PLIERS	101	COTTON HOLDERS	150	ENDO FINGER RULER SPAN MEASURE SCALE	96
ADERER LARGE WIRE BENDING AND LOOP FORMING PLIERS	100	CARRY FORCEPS	134	ENDO FINGER RULER SPAN MEASURE SCALE	151
ADERER PLIER	101	CARVER HOLLENBACK AMALGAM CARVERS	56	FORCEPS JAR	149
AMALGAM GUN	151	CARVERS FILLING INSTRUMENTS	69	FALCON BEAK CONTOURING PLIERS	100
ARROW CLASP FORMING PLIERS	106	CARVERS INSTRUMENTS	73	FARABEU RETRACTOR	82
ADISON BROWN TWEEZERS	93	CARVERS	71	FELDMAN RETRACTOR	82
ADISON CARBIDE TIPPED TISSUE FORCEPS	133	CASTORVIEJO NEEDLE HOLDERS	86	FILES FILLING INSTRUMENTS	53
ADISON NEEDLE HOLDERS	86	CASTORVIEJO SCISSORS	84	FILLING INS PERIODONTAL INSTRUMENTS	37, 44, 49-55, 69, 72
ADISON TWEEZERS	32	CEMENT SPATULAS	75	FILLING INSTRUMENTS	37, 44, 49-55, 69, 72
ADISON-TC TWEEZERS	32	CHEEK RETRACTOR LONG	80	FLAT NOSE Plier SMOOTH	105
ALLEN PERIOSTEAL ELEVATORS	95	CHEEK RETRACTOR	78	FLAT NOSE PLIER WITH SERRATION	105
ALLIS 4.5 HAEMOSTATIC FORCEPS	87	CHEEK RETRACTORS, MINNESOTA	80	FLOHR ROOT ELEVATORS	20
ALLIS-BABY 3.4 HAEMOSTATIC FORCEPS	87	CHEEK RETRACTORS, RETRACTOR IVORY	80	FLUCH-CUT DISTAL AND CUTTING PLIERS	100
AMALGAM CARVERS	56-57, 70-71	CHEEK RETRACTORS, TONGUE DEPRESSORS	80	FOERSTER DRESSING FORCEPS	100
AMALGAM FILES	71	CHISELS HOES FILLING INSTRUMENTS	74	FORCEP JAR	148
AMALGAM INSTRUMENTS & SCALPEL HANDLES	92	CLAMP, OSTEOMETER	109	FREEDMAN "DUCKHEAD" IMPLANTOLOGY INSTRUMENTS	112
AMALGAM INSTRUMENTS	93	CLAPPISON/FRAHAM RESTORATIVE INSTRUMENTS	70	FREEDMAN BURNISHERS IMPLANTOLOGY INSTRUMENTS	112
AMALGAM WELL MATRIX RETAINERS	91	CLAW-LIFT ROOTS ELEVATOR	22	FREER PERIOSTEAL ELEVATORS	95
AMALGAM WELL	93	COHEN UNIVERSAL FORCEPS	10-11	FRIEDMAN BONE ROUNGER	14
ANATOMICAL CARVER	71	COLLEGE CURVED	32	FRIEDMANN ROOTS ELEVATOR	21
ANDREW RESTORATIVE INSTRUMENTS	70	COLLEGE TWEEZER	32	GAUGE FOR MEASURING	109
ANGLE FORMERS	72	COLLEGE WITH LOCK TWEEZERS	31	GERALD TWEEZERS	31
ANGLED DIRECT BOND BRACKET REMOVER TC	106	COLLINS TONGUE FORCEPS	31	GILLES TWEEZERS	31
ANISWORTH CLAMPS FORCEPS	88	COMPOSITE/PLASTIC FILLING INSTRUMENTS	49-50, 54	GILLIES NEEDLE HOLDER WITH SCISSORS	31
ANTERIOR FILLING INSTRUMENTS	58	CONDENSER INSTRUMENTS	118	GOLDMAN FOX EXPLORERS	36
ANTERIOR	47	CONDENSER MORTONSON FILLING INSTRUMENTS	50	GOLDMAN FOX MERRIT B. EXPLORERS	36
APEXO ROOT ELEVATORS	15-19	CONTOURING INSTRUMENT IMPLANTOLOGY INSTRUMENTS	111	GOLDMAN FOX UNIVERSITY OF MICHIGAN EXPLORERS	36
APICAL ROOT ELEVATORS	19	CONTOURING PLIER	101	GOLDMAN FOX WILLIAMS EXPLORERS	36
ARCH FORMING PLIERS	104	COSMETIC CONTOURING	113	GOLDMAN PERIODONTAL INSTRUMENTS	58
ARTICULATORS	77	COTTON HOLDER	148	GOLDMAN FOX PERIODONTAL ELEVATORS	95
A-TRAUMATIC EXTRACTION SET	03	COUPLAND ROOT ELEVATORS	18	GOLDMAN-FOX SCISSORS	53-54
ATRAUMATIC TWEEZERS	31	COUPLAND ROOT ELEVATORS	18	GOLDMAN-FOX SET	61
BACK ACTION FILLING INSTRUMENTS	52	CRANE KAPLAN TWEEZERS	32	GOLDSTEIN INTERPROXIMAL EXCAVATOR	87
BACKHAUS HAEMOSTATIC FORCEPS	87	CRANE-KAPLAN PERIODONTAL INSTRUMENTS	59	GRACEY AFTER FIVE	42
BACOLITE HANDLE WAX KNIVES	76	CRILE NEEDLE HOLDERS	85	GRACEY CURETTE INSTRUMENTS	52
BALDWIN FILLING INSTRUMENTS	49	CRILE-WOOD NEEDLE HOLDERS	85-86	GRACEY CURETTE SET CASSETTES	147
BALL FILLING INSTRUMENTS	52	CROWN AND BAND CONTOURING PLIERS	105	GRACEY CURETTE	42
BALL HOOK CRIMPING PLIER	105	CROWN REMOVER	90	GRACEY MINI FIVE	42
BAND PUSHER	90	CROWN SPREADERS	90	GRACEY PERIODONTAL INSTRUMENTS	40-41
BAND REMOVING PLIER	99	CRAYER EXTRACTING FORCEPS	10	GRACEY SET OF 7 PCS	40-41
BAND SEATER AUTO CLEAVABLE	97	CRAYER ROOTS ELEVATOR	23	GRAFT PACKER, CONCAVE TIPS	125
BAND SEATING PLIER	104	CURETTE COLUMBIA	43	GREGG IMPLANTOLOGY INSTRUMENTS	111
BANDS & CROWNS PLIER	101	CURETTE INSTRUMENTS	63	GRITMAN CEMENT SPATULAS	75
BASINS FOR BONE	138	CURETTE MCCALL	43	GROSS MAIER DRESSING FORCEPS	109
BAUMGARTNER NEEDLE HOLDERS	85	CURETTE	60	GUM SCISSORS	31
BAUMGARTNER NEEDLE HOLDERS	86	CURETTERS SET OF 8 PIECES	43	HAEMOSTATIC FORCEPS & TOWEL CLAMPS	87
BAYONET ROOTS ELEVATOR SET	21	CURETTES	40-43, 61-62	HALSEY NEEDLE HOLDERS	85-86
BEAUFORT FILLING INSTRUMENTS	52	CUTTING INS PERIODONTAL INSTRUMENTS	39	HALSTEAD MOSQUITO HAEMOSTATIC FORCEPS	87
BEEBEE NEEDLE HOLDERS	85	DARBY-PERRY EXCAVATORS	85	HALSTEAD MOSQUITO NEEDLE HOLDERS	86
BEIN ROOT ELEVATORS	15-16, 24	DE LA ROSA PLIERS WITH GROOVED	105	HALTEPINZETTE WITH LOCK	134
BEYER BONE ROUNGER	14	DE LA ROSA PLIERS	105	HAMMER HEAD TIE BACK PLIER	104
BINANGLE FILLING INSTRUMENTS	74	DEAN SCISSORS	84	HANDLES FOR MOUTH MIRRORS	30
BIRD BEAK ANGLED BENDING PLIER	103	DEBAKEV ATRAUMATIC TISSUE FORCEPS	133	HARD WIRE CUTTERS	107
BIRD BEAK PLIER WITH TC	102	DEEP BOWL	148	HARRIS EXTRACTING FORCEPS	11
BIRD BEAK WIRE BENDING & CUTTING PLIERS	101	DEEP ROOT PICK FORCEPS (APICAL SET OF 9)	04	HARTMANN (BABY MOSQUITO) NEEDLE HOLDERS	86
BIRD BEAK WIRE BENDING PLIER	100	DELICATE NEEDLE HOLDERS	85	HATCHETS FILLING INSTRUMENTS	68
BIRD BEAK WITH CUTTER PLIERS	104	DELUXE BRACKET HOLDER TWEEZERS	96	HEAT CARRIERS	46
BLACK FILLING INSTRUMENTS	50	DENHARD CHEEK RETRACTORS	79	HEBER ROOTS ELEVATOR	24
BLACK TITANIUM COLOUR COATED INSTRUMENTS	110-111	DENTAL MIRROR PERIODONTAL INSTRUMENTS	39	HEIDBRINK ROOT ELEVATORS	20-21, 26
BLADE AND PUSHER	126	DENTAL SYRINGES	13	HEIDMANN PERIODONTAL INSTRUMENTS	39
BLUMENTHAL BONE ROUNGER	14	DERF NEEDLE HOLDERS	85	HEMINGWAY CURETTE INSTRUMENTS	63
BOGHOSIAN FILLING INSTRUMENTS	49	DERF NEEDLE HOLDERS	86	HEMINGWAY TWEEZERS	32
BOGHOSIAN IMPLANTOLOGY INSTRUMENTS	111	DIRECT BOND BRACKET HOLDER TWEEZERS	96	HOES	71
BOLEY GAUGE	109	DIRECT BONDING BRACKET HOLDERS	96	HOLLANBACK PERIODONTAL INSTRUMENTS	39
BONE BRACKET GAUGE	96	DIRECT BONDING BRACKET REMOVER PLIER TC	106	HOLLANBACK FILLING INSTRUMENTS	56
BONE CARRIER TITANIUM	124	DIRECT BRACKET REMOVER TC	107	HOLLANBACK IMPLANTOLOGY INSTRUMENTS	114
BONE CRUSHER	138, 140	DISCOID-CLEOID CARVER	71	HOLLANBACK RESTORATIVE INSTRUMENTS	70
BONE EXPANDER SCREW & SURGICAL KITS	141	DISTAL END CUTTER REGULAR WITH T.C	102	HOLLOW HANDLE	132
BONE FILES	94	DISTAL END CUTTER, SAFETY HOLD PLIER	102	HOLLOW WARE	148
BONE GRAFT CARRIER TITANIUM	128	(IDEAL FOR CUTTING WIRE) TC	107	HOLLOWCHOP CONTOURING PLIERS	106
BONE GRAFTING INSTRUMENTS COMPACTOR/TAMPERS	125	DISTAL END, WIRE CUTTERS & BRACKET REMOVER PLIERS	107	HOOK CRIMPING PLIER ANGLED STRAIGHT TC	107
BONE GRAFTING INSTRUMENTS	126-127	DOUBLE ENDED CEMENT SPATULA	98	HOOK KNIVES	76
BONE INJECTORS, COLLECTORS & SUCTION TUBE	142	DISTAL CUTTER	106	HOW PLIER CURVED WITH TC	103
BONE MILL	138	DRESSING TWEEZERS	31-32	HOW PLIER CURVED	99, 104
BONE ROUNGER	14	DENTAL SYRINGES ALL TYPES	14H	HOW PLIER STRAIGHT WITH TC	103
BONE SCRAPER STRAIGHT & CURVED	138	ELASTIC SEPARATING PLIER	107	HOW PLIER STRAIGHT	103
BONE SPOON/PACKER	125	ELASTOMERIC LIGATURE PLACING FORCEPS	107	HOWARD PERIOSTEAL ELEVATORS	95
BONE THICKNESS GAUGE	109	WITH GROOVE FALCON	107	HYGIENIST PERIODONTAL INSTRUMENTS	58
BONE UNIVERSAL KIT	141	ELLIOT MATRIX RETAINERS	91	HYGIENIST-JACQUETTE PERIODONTAL INSTRUMENTS	58
BRACKET REMOVER ANGULATED PLIER	103	ENDED CHEEK RETRACTORS	79	HYGIENIST-TOWNER PERIODONTAL INSTRUMENTS	58
BRACKET REMOVER PLIER STRAIGHT	103	ENDODONTIC BOX	148	HYLIN CEMENT SPATULAS	75
BRACKET REMOVER PLIERS ANGLED WITH T.C	102	ENDODONTICS INSTRUMENTS	47	HYLIN ROOTS ELEVATOR	23
BRACKET REMOVER PLIERS STRAIGHT WITH T.C	102	ENGLISH PATTERN KLEIN #3 PEDODONTIC UNIVERSAL FORCEPS	08	HEIGHT GAUGE MOVABLE	96
BRACKET REMOVING PLIER ROUND BOX	99	EXAMINATION KIT SET OF 3 PIECES	34	IMPLANT GAGES	108
BRACKET REMOVING PLIER	99	EXAMINATION SET OF 4 PIECES	34	IMPLANT SINUS LIFT INSTRUMENTS	117, 122
BREWER CLAMPS FORCEPS	88	EXAVATORS	37	IMPLANT	123
BURNISHER FILLING INSTRUMENTS	49	EXCAVATOR PERIODONTAL INSTRUMENTS	39	IMPLANTOLOGY IMPLANTOLOGY INSTRUMENTS	112
BURNISHER FILLING INSTRUMENTS	56	EXCAVATORS INSTRUMENTS SET OF 11 PIECES	57	IMPLANTOLOGY INSTRUMENTS	111
BURNISHER UNIVERSITY OF MICHIGAN AMALGAM CARVERS	54	EXCAVATORS INSTRUMENTS	54-57	IMPLANTOLOGY	108-110
BURNISHERS FILLING INSTRUMENTS	52-53	EXCAVATORS	64	IMPRESSION TRAYS	143-146
BURNISHERS IMPLANTOLOGY INSTRUMENTS	112	EXPLORER PERIODONTAL INSTRUMENTS	39	INSTRUMENTS BOX	148
BUSER PERIOSTEAL ELEVATORS	95			INSTRUMENTS CASSETTES & STANDS	147

DESCRIPTION	PAGE #	DESCRIPTION	PAGE #	DESCRIPTION	PAGE #
INSTRUMENTS BOX	149	NANCE LOOP FORMING PLIERS	99	ROUND NOSE PLIER	104
NEEDLES BOX	149	NANCE PLIER	105	ROUNDED CONE	73
INTERPROXIMAL CARVER IMPLANTOLOGY INSTRUMENTS	111	NARROW MATRIX RETAINERS	91	ROUNDED CONE FILLING INSTRUMENTS	49
INTERPROXIMAL OFF-ANGLE FILLING INSTRUMENTS	49	NEEDLE HOLDERS	85-86	RUBBER DAM CLAMPS	89
INTRALIGAMENTAL ANESTHESIA SYRINGE	13	NEUMANN SCISSORS	84	RUBBER DAM CLAMPS FORCEPS	134
IRIS SCISSORS	83-84	NOYES SCISSORS	84	RUSSIAN LONG TISSUE FORCEPS	134
IVORY LIGHT WEIGHT CLAMPS FORCEPS	88	NEEDLE CASE ROUND WITH COVER	150	RUSSIAN TISSUE FORCEPS	148
IVORY MATRIX RETAINERS	91	OCCUSAL ANATOMY INSTRUMENT	113	SCALER TRAY	80
WANSON SPRING CALIPER	109	OHL PERIOSTEEL ELEVATORS	95	SCALER/CURETTE SETS	61
JACQUETTE SCALERS PERIODONTAL INSTRUMENTS	59	OLSEN-HEGAR NEEDLE HOLDER WITH SCISSORS	51	SCALER/CURETTE SETS INSTRUMENTS	97
JARA BEAK PLIER	104	OREGON PLUGGERS/CONDENSERS	98	SCHURE BAND SEATER	58
JENNINGS CHEEK RETRACTORS	79	ORTHO BAND PUSHER SCALER	97	SEPARATING ELASTIC PLIER	95
JOHNSON CONTOURING PLIERS	100	ORTHO INSTRUMENT	98	SELDIN PERIOSTEEL ELEVATORS	82
JONES HAEMOSTATIC FORCEPS	87	ORTHO LIGATURE DIRECTOR SINGLE ENDED	97-98	SELDIN RETRACTOR	15-18, 25
JOSEPH SCISSORS	87	ORTHO LIGHT BAND PUSHER SCALER	98	SELF LOCKING GROOVED	33
KELLY HAEMOSTATIC FORCEPS	83-84	ORTHO LIGHT DOUBLE ENDED LIGATURE DIRECTOR SCALER	98	SELF-LOCKING TWEEZER	32
KELLY SCISSORS	87	ORTHO LIGHT DOUBLE ENDED LIGATURE DIRECTOR	98	SEMKEN TAYLOR TWEEZERS	39
KELLY-RANKIN HAEMOSTATIC FORCEPS	139	ORTHO LIGHT DOUBLE ENDED LIGATURE SCALER/DIRECTOR	98	SICKLE PERIODONTAL INSTRUMENTS	39
KEYS FOR IMPLANT SCREW	148	ORTHO LIGHT LIGATURE DIRECTOR DOUBLE ENDED	97	SICKLE SCALERS INSTRUMENTS	33
KIDNEY TRAY WITH COVER (ENGLISH PATTERN)	148	ORTHO LIGHT SCALER DOUBLE ENDED	97	SINGLE ENDED PROBE	115-116
KIDNEY TRAYS	148	ORTHO LIGHT SCALER HEAVY	98	SINUS LIFT ELEVATOR	118-121
KILNER (RAGNELL) SCISSORS	14	ORTHO LIGHT SCALER SINGLE ENDED	97	SINUS LIFT INSTRUMENT	106
KLEINERT-KUTZ BONE ROUNDER	23-24	ORTHO LIGHT SCALER	96-98	SINUS WINDOW BONE TAMPERS	127
KOPP ROOTS ELEVATOR	94	ORTHODONTIC INSTRUMENTS	96	SINUSLIFT INSTRUMENTS	118
KRÄRMER-NEVINS BONE CHISEL	83-84	ORTHOLITE LIGATURE DIRECTOR SCALER	96	SIOVELAND RETAINERS TOFFLEMIRE-JUNIER MATRIX RETAINERS	91
LA GRANGE SCISSORS	52	OSTEOMETER MEASURING FORCEPS	65	SMAHA ELASTOMERIC LIGATURE PLACING FORCEPS	107
LADMORE FILLING INSTRUMENTS	112	OSTEOTOME CONVEXES / CONCAVE / CONIQUES	73	SPENCER SCISSORS	148
LADMORE IMPLANTOLOGY INSTRUMENTS	52	OVAL SPOONS/DARBY-PERRY	88	SPIRIT LAMP	128
LAP-JOINT THREE PRONG PLIER	106	P.K. THOMAS WAXING INSTRUMENTS	29-29	SPOON AND PUSHER (TRINOVO)	128
LAXUTOR ROOT ELEVATORS	19	PALATAL ARCH PLIER	99	SPOON AND PUSHER WITH SAFETY STOP	128
LE CRON CEMENT SPATULAS	75	PALMER CLAMPS FORCEPZ	109	SPOONS	64
LESSMANN	76	PDL ELEVATORS	53	SPREADERS	46
LIGATURE FORMING PLIERS	101	PEDIATRIC TOOTH EXTRACTING FORCEPS SET	53	STANDARD LIGATURE CUTTER TC	106
LIGHT WIRE BIRD BEAK LONG PLIER WITH TC	102	PERIODONTAL FILLING INSTRUMENTS	37, 39, 58, 60, 95	STEP PLIERS WITH TC	103
LIGHT WIRE BIRD BEAK LONG PLIER	104	PERIODONTAL INSTRUMENTS	46, 48	STERILIZING DRUM	148
LIGHT WIRE BIRD BEAK PLIERS	104	PERIODONTAL PROBES	95, 129-130	SPLIT LAMP SINGLE NUT	150
LIGHT WIRE CUTTER MICRO WITH TC	102	PERIOSTEAL ELEVATOR	26	SPIRIT LAMP	150
LIGHT WIRE PLIER	104	PERIOTOME ROOTS ELEVATOR	31-32	SUCTION CANNULA KIT	151
LINDO LEVIAN ROOT ELEVATORS	20	PERRY TWEEZER	103	STERILIZING CASES STAINLESS STEEL	149
LINGUAL / PALATAL ARCH FORMING PLIERS	101	PESTERIOR BEND REMOVER PLIER LONG	103	STOP V BENDING PLIER	105
LINGUAL PLIER LONG HANDLE	106	PESTERIOR BEND REMOVER PLIER MEDIUM	103	STRAIGHT DIRECT BOND BRACKET REMOVER TC	107
LINGUAL PLIER WEINGART	106	PESTERIOR BEND REMOVER PLIER SHORT	106	SURGICAL CHISELS	123
LINGUAL WEINGART PLIER	106	PIN & LIGATURE CUTTERS TC	107	SURGICAL TWEEZERS	31
LINING APPLICATOR DOUBLE END	55	PIN HOLDING PLIER TC	107	SUTURE PLIERS SUTURE FORCEPS	133
LOCKLIN SCISSORS	84	PIN-TWEEZERS	134	SYNDESMOTOMES ROOTS ELEVATOR	26
LONDON COLLEGE TWEEZERS	87	PLAIN MIRRORS	99-106	TAMPER	126
LORNA HAEMOSTATIC FORCEPS	31	PLASTER KNIFE 78 SPECIAL INOX	99	TANNER FILLING INSTRUMENTS	52, 69
LUCAS	132	PLIERS FOR ORTHODONTICS & PROSTHETICS	56	TANNER IMPLANTOLOGY INSTRUMENTS	114
LUER BONE ROUNDER	14	PLUGGER PERIODONTAL INSTRUMENTS	45, 48	TC GRIPPER CARBIDE	133
LUKS	47	PLUGGER BLACK AMALGAM CARVERS	51	THARP RESTORATIVE INSTRUMENTS	70
LUXATOR ROOT ELEVATORS	15-16, 21	PLUGGERS	51	THREE PRONG PLIERS REGULAR	106
LUXIER ROOTS ELEVATOR	22	PLUGGERS/CONDENSERS FILLING INSTRUMENTS	60	TISSUE GRAFT FORCEP SERRATED TEETH	133
MAGNIFYING MIRRORS	30	PLUGGERS/CONDENSERS	36	TISSUE MEMBRANE FORCEPS	132, 134
MANUAL CROWN REMOVER	90	POINTED CURETTE	48	TISSUE PUNCH FORCEPS	138
MARCOTTE LOOPING PLIER	105	POINTED PROBES SINGLE ENDED	102	TISSUE PUNCH STRAIGHT & CURVED	138
MARGIN TRIMMERS	72	POSTERIOR	25	TOFFLEMIRE-SENIOR MATRIX RETAINERS	91
MARGINAL RIDGE & EMBRASURE SHAPING INSTRUMENT	113	POSTERIOR BAND REMOVER PLIERS	90	TOFFLEMIRE-UNIVERSAL MATRIX RETAINERS	139
MARKLEY PLUGGERS/CONDENSERS	51	POTT ROOTS ELEVATOR	95	TOWNER PERIODONTAL INSTRUMENTS	58
MARQUETTE FILLING INSTRUMENTS	50	POWER CROWN REMOVER LIFT	35	TOWNER-JACQUETTE PERIODONTAL INSTRUMENTS	137
MARYAM TWEEZERS	86	PRICHARD PERIOSTEEL ELEVATORS	34	TUFTS FILLING INSTRUMENTS	49
MATHEU NEEDLE HOLDERS	91	PROBES DOUBLE ENDED	49	TUNNELIERUNGS INSTRUMENT	126
MATRIX RETAINERS	85	PROBES SINGLE ENDED	131	TWEED / ANGEL FORMING AND TORQUING PLIERS	101
MAYO NEEDLE HOLDERS	83	QUETIN FILLING INSTRUMENTS	129, 131	TWEED / ANGLE RECTANGULAR ARCH FORMING & TORQUING PLIERS	100
MAYO SCISSORS	85-86	RASPATOR, BENOUE	131	TWEED ARCH FORMING PLIER TC	102
MAYO-HEGAR NEEDLE HOLDERS	14	RASPATOR, FREER	124	TWEED CUTTER PLIER	100
MEAD 1A BONE ROUNDER	94	RASPATOR, MICRO FREER	131	TWEED LOOP FORMIN PLIERS	100
MEAD BONE FILES	109	RASPATOR, MICRO RASPATOR / CHISEL	129	TWEED LOOP FORMING PLIER TC	105
MEASURING LOOP	75	RASPATOR, MICRO-FREER	131	TWEED LOOP FORMING PLIERS	99
MEASURING LOOP, CASTROVIEJO	114	RASPATOR, NORDBERG	131	TWEED LOOP PLIER	104-105
MEDIUM CEMENT CEMENT SPATULAS	118	RASPATOR, PRICHARD	95	TWEEZER PERIODONTAL INSTRUMENTS	39
MEDIUM PLACING/CONDENSING IMPLANTOLOGY INSTRUMENTS	114	RASPATOR, RASPIATRY PERIOSTEEL ELEVATORS	131	TWEEZERS	32
MEMBRANE POSITIONING INSTRUMENTS	134	RASPATOR, WAUTIER	95	TWEEZERS	97
MEMBRANE TWEEZERS KUEHNE	31	RASPATOR, WILLIGER PERIOSTEEL ELEVATORS	88	TWIEL-ON ELASTIC MODULE INSTRUMENT	59
MERIAM TWEEZERS	36	RUBBER DAM FRAME	131	UNIVERSAL DOLPHIN STYLE WIRE BENDING & CUTTING PLIERS	49
MERRIT 4 EXPLORERS	36	RASPATORY CHIPPING	80-82	UNIVERSAL FILLING INSTRUMENTS	54
MERRIT 8 EXPLORERS	90	RASPATORY MICRO MOLT	81	UNIVERSAL FILLING INSTRUMENTS	85
MERSHON CROWN REMOVER	85	RASPATORY MOLT	104	UNIVERSAL NEEDLE HOLDERS	36
METZENBAUM NEEDLE HOLDERS	83	REGULAR TWEED ARCH FORMING PLIERS	51-53, 68, 70-72	UNIVERSAL Plier WEINGART TC	107
METZENBAUM SCISSORS	133	RESTORATIVE INSTRUMENTS	90	V BEND STOP PLIER TC	106
MICOR ADSON TISSUE FORCEP	83	RETRACTOR WITH ERGO GRIP	78-79	W. BARRY ROOTS ELEVATOR	25
MICRO IRIS SCISSORS	14	RETRACTORS - MOUTH GAGS	80-82	URINAL FEMALE, URINAL MALE, URINAL MALE VERTICAL	150
MICRO-FRIEDMAN BONE ROUNDER	94	RETRACTORS	81	WAHL BONE FILES	89
MILLER BONE FILES	32	RETRACTORS CHEEK RETRACTOR COMBINATION COMBINATION	81	WALDSAVHS WIRE BENDING AND CUTTING PLIERS	101
MILLER TWEEZERS	132	RETRACTORS COMBINATION	82	WALL FILLING INSTRUMENTS	69
MILLER	100	RETRACTORS LANGENBECK	81	WANGEN HOLDER	56
MINI LIGATURE CUTTERS	106	RETRACTORS, MINI-LANGENBECK	81	WARD AMALGAM CARVERS	69
MINI PIN & LIGATURE CUTTER TC	124	RETRACTORS, UNIQUE	48	WARD FILLING INSTRUMENTS	76
MIXING SPATULA WITH SHOVEL	60	RETRO FILLING	102	WAX KNIVES	71
MODIED MOCALL	94	REVERSED LIGATURE CUTTER ANGLED	30	WEDELSTAEDE	103
MOLT BONE FILES	95	RHODIUM MIRRORS	87	WEINGART GENERAL UTILITY PLIER LONG MOUTH WITH TC	99-101
MOLT PERIOSTEEL ELEVATORS	55	ROCHESTER-KOCHER 1X2 HAEMOSTATIC FORCEPS	15-29		
MORTONSON FILLING INSTRUMENT	78	ROCHESTER-PEAN HAEMOSTATIC FORCEPS	34		
MOUTH GAG MOLT	37	ROOT ELEVATOR	22		
MOUTH MIRROR	75	ROOT PLANNING FILES	79		
MSY CEMENT SPATULAS	108	ROOT PLANNING FILES & BONE FILES	22		
MULTIFUNCTIONAL METER	740	ROOTS ELEVATOR	79		
MISCELLANEOUS PRODUCTS	77	ROSER-KÖNIG CHEEK RETRACTORS			
NAKAWALLI DENTAL LABORATORY INSTRUMENTS					



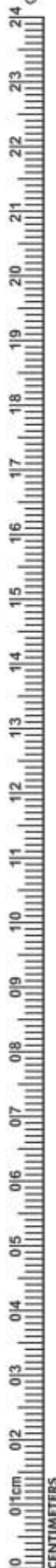

DESCRIPTION	PAGE #	DESCRIPTION	PAGE #	DESCRIPTION	PAGE #
WEINGART PLIER REGULAR WITH TC	103				
WEINGART PLIER SLIM WITH TC	102				
WEINGART PLIER UNIVERSAL WITH TC	103				
WEINGART PLIER UTILITY WITH TC	103				
WEITLANDER CHEEK RETRACTORS	79				
WEITLANDER CHEEK RETRACTORS	79				
WERDELSTAEDT FILLING INSTRUMENTS	74				
WESTON CEMENT SPATULAS	75				
WIDE MATRIX RETAINERS	91				
WILLIAM PROBE SET	38				
WILLIAMS EXPLORERS	36				
WINGURT PLIER SLIM	105				
WINGURT UTILITY PLIER	105				
WINTER ROOTS ELEVATOR	25				
WIRE BENDING & LOOP FORMING PLIERS	99				
WISDOM ROOTS ELEVATOR	21				
WOODEN HANDLE	76				
WOODSON FILLING INSTRUMENTS	49				
YOUNG PLIER WITH GROOVED	105				
YOUNG TONGUE FORCEPS	...				
YOUNG WIRE BENDING & LOOP FORMING PLIERS	99				
ZAHLE CEMENT SPATULAS	75				





# AURIGA

INTERNATIONAL

**Manufacture & Exporter of High Quality Dental Instruments.**

**PAKISTAN OFFICE:**

P.O.BOX 1176  
SMALL INDUSTRIES  
ESTATE SIALKOT PAKISTAN.  
Ph: +92-52-3256447  
Fax: +92-52-3550178

E-mail:-mriaz@skt.comsats.net.pk  
infoadmin@aurigainst.com  
aurigainst@gmail.com  
auriga786@gmail.com  
aurigainst@yahoo.com

**U.S.A OFFICE:**

Auriga Instruments  
P.o. Box 190279  
Brooklyn 11219.n.usa.  
E-mail:- aurigainc@hotmail.com  
Web: www.aurigainst.com

ISO  
9000 : 2000

GMP  
EN 46000  
CERTIFICATION

